



**DCS GUIDE**  
**Mi-8MTV2**

By Chuck  
Last Updated: 20/09/2023



# TABLE OF CONTENTS

- PART 1 – INTRODUCTION
- PART 2 – CONTROLS SETUP
- PART 3 – COCKPIT & GAUGES
- PART 4 – PRE-FLIGHT & MISSION PLANNING
- PART 5 – START-UP
- PART 6 – TAKEOFF
- PART 7 – LANDING & SHUTDOWN
- PART 8 – ENGINES & ANCILLARY SYSTEMS
- PART 9 – PRINCIPLES OF HELICOPTER FLIGHT
- PART 10 – AUTOROTATION
- PART 11 – MISSION TYPES AND ROTORCRAFT OPERATION
- PART 12 – WEAPONS & COUNTERMEASURES
- PART 13 – RADIO TUTORIAL
- PART 14 – RADIO NAVIGATION
- PART 15 – AP-34B AUTOPILOT
- PART 16 – MULTICREW
- PART 17 – OTHER RESOURCES



The Mil Mi-8 “Magnificent Eight” is truly the most underrated module in the DCS hangar. Why does the Huey get all the love while the Mi-8 gathers dust? The answer is simple: people just don’t know much about it.

Buying a DCS module is just like buying a car: in order to want it, you need an emotional connection with it. Since ~~Capitalist Pigs~~ Westerners like myself have grown up watching movies about the Vietnam War and Hueys dropping GIs into the jungle, we have not heard much about the Mi-8 helicopter. Yet, the Mi-8 has a long and rich history and is a big part of the Russian aviation heritage. The Americans had Vietnam and the Huey... the Soviet Union had Afghanistan and the Mi-8.

During the Soviet-Afghan war of 1979-1989, the Mi-8s confirmed that saving human lives is the main task for a rotary-wing machine. Search-and-rescue missions made up on average 10 percent of the total number of the army aviation sorties. For many soldiers, the helicopter remained their last hope. The history of the Mi-8’s employment in the 40th Army contains countless examples when airmen who had ejected after being shot down, wounded or sick soldiers and personnel cut off from their units were sought out and evacuated. In most cases such operations were conducted under fierce fire and were performed by the crews of the Mil’ ‘workhorses’, at the immediate risk of their own lives. It is the Mi-8 that allowed the Soviet forces in Afghanistan to fulfill the order stipulating that not a single wounded, shell-shocked or dead soldier should be left behind on the battlefield.

For its wonderful performance characteristics, handling, and ease of flight and maintenance operations, personnel transitioning from the Mi-4 to the Mi-8 dubbed the new helicopter “Vasilissa the Beautiful”. By 1969, the Mi-8 completely replaced the Mi-4 on the production line. Its production rates grew year by year reaching several hundred helicopters per year. From 1965 to 1996, the Kazan Helicopter Plant manufactured, in different modifications, a total of four and a half thousand Mi-8s powered by TV2-117 engines. In 1970, the Ulan-Ude Helicopter Plant started production of the Mi-8 in parallel with Kazan. To date this facility has produced more than 3700 Mi-8s powered by TV2-117 engines. In 1981, the Mi-8MT debuted at the Paris air show. For promotional reasons, it was designated Mi-17, which became its export designation on the world market. This is why we have public access to Mi-17 manuals (which are the same as the ones for the Mi-8 in everything but name).

The Mi-8 is a delight to fly. You feel like a shirtless badass riding a polar bear in the Siberian winter. It is very stable, very powerful and the minute you leave the ground, you will instantly understand why the Russians called the Mi-8 “the Magnificent Eight”.



Mikhail Leontyevich Mil  
Михаил Леонтьевич Миль  
(1909-1970)





“HELICOPTERS SUCK!” is the first thing I said when I crashed my Huey for the first time. This is what many people among the flight sim community think as well. Choppers are slow, blocky, noisy, sluggish... who would want to be a glorified taxi driver when you could be Maverick and save the world at Mach 1.5?

Well, you should! Why? Simply because helicopter pilots have one of the most dangerous jobs in the world. You have to be one hell of a pilot to fly one of those. Or batshit insane. Or a bit of both. Flying a helicopter is challenging, and one of the most rewarding experiences I ever had in a flight sim.

Flying helicopters is difficult, much more difficult than flying an airplane. Helicopters are marvellous and totally insane creations. They seem unnatural, intricate and many pilots who come from the jet or prop plane world have difficulties to learn to fly helicopters since it requires a different way of thinking. I had the chance to meet a real life Huey pilot who was kind enough to show me the basics of how to “think” like a chopper pilot. I will attempt to share what I learned from him with you, and hopefully you will benefit from it like I did.

It took me many tries, many crashes, a lot of cursing... but in the end I realized that the DCS MI-8, alongside the UH-1H Huey, is one of the most fun and interesting modules I ever had the chance to fly. Real-life helicopter pilots agree with me on this: the Mi-8 you are about to fly is one of the finest modules ever made flight model wise, on par with the Huey (also created by Belsimtek). If you think you learned to fly choppers from ARMA, Take On Helicopters, FSX or Battlefield, think again. You’ve seen nothing yet. The Vortex Ring State is one brutal wake up call. 😊

“Peter Pilot” is the nickname given to novice helicopter pilots. At the beginning, we all suck. Get used to it, and you won’t feel as frustrated as I was in the beginning. The human brain is just not engineered to think like a helicopter... but with proper training and a bit of practice, you will get the hang of it in no time. Understanding is half the training, so put your thinking cap on.

Give the Mi-8 a chance, and I promise you that you will not regret it.





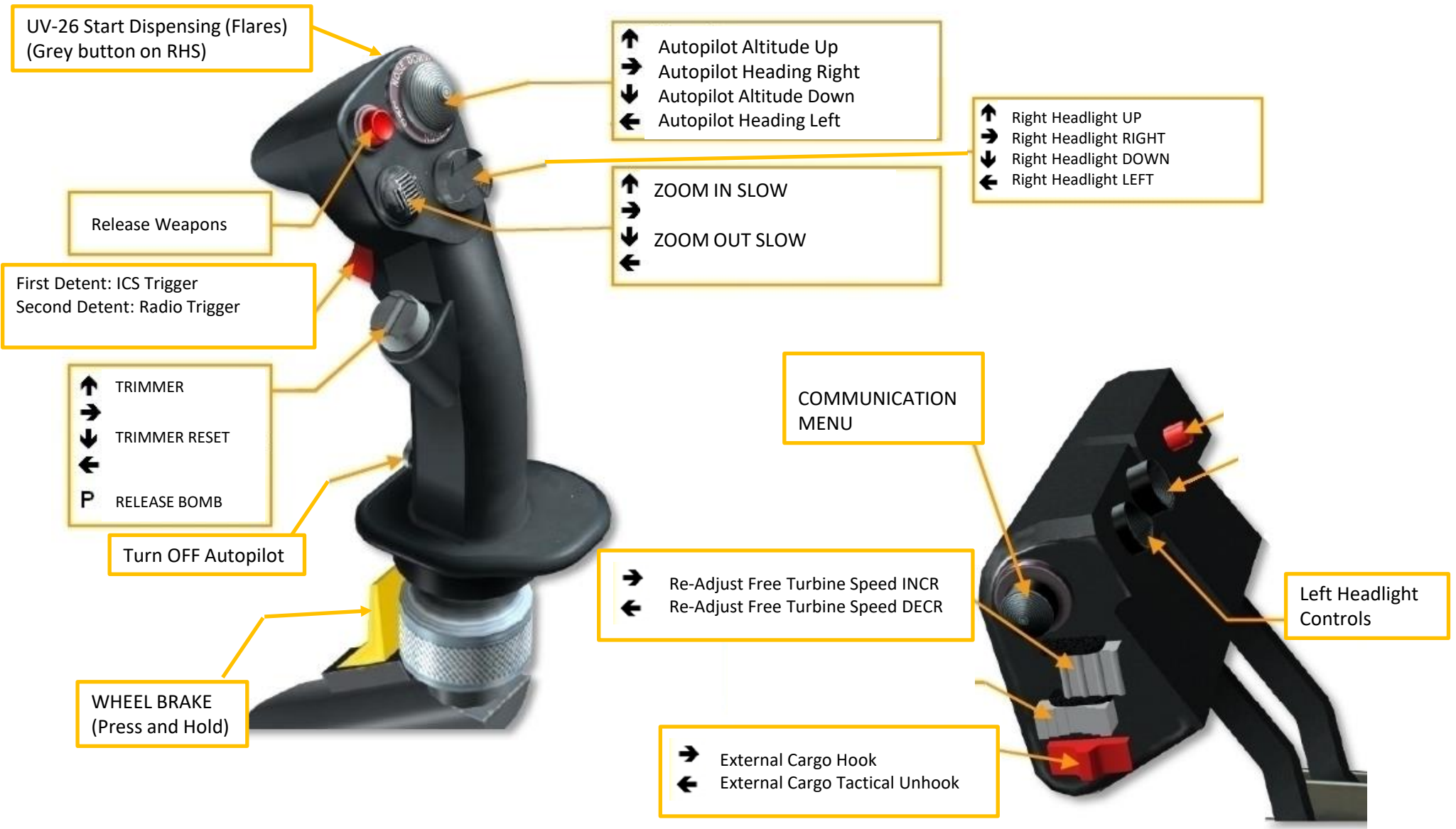



# CONTROLS FOR GUNNERS, CREW & INTERFACE MANAGEMENT

- SET PILOT SEAT  
SWITCHES TO PILOT SEAT (“1” BY DEFAULT)
- SET COPILOT SEAT  
SWITCHES TO COPILOT SEAT (“2” BY DEFAULT)
- SET TECHNICIAN SEAT  
SWITCHES TO FLIGHT ENGINEER SEAT (“3” BY DEFAULT)
- SET (LEFT) GUNNER SEAT  
SWITCHES TO LEFT GUNNER SEAT (“4” BY DEFAULT)
- AI (LEFT) GUNNER ROE ITERATE (L\_CTRL+ L\_WIN+4)  
ITERATES RULES OF ENGAGEMENT LEFT GUNNER  
HOLD FIRE / RETURN FIRE / FREE FIRE (AT WILL)
- AI BACK GUNNER ROE ITERATE (L\_CTRL + 5)  
ITERATES RULES OF ENGAGEMENT REAR GUNNER  
HOLD FIRE / RETURN FIRE / FREE FIRE (AT WILL)
- AI (LEFT) GUNNER BURST SWITCH (L\_SHIFT+ L\_WIN+4)  
ITERATES FIRING BURST LENGTH FOR LEFT GUNNER  
SHORT BURST / LONG BURST
- AI BACK GUNNER BURST SWITCH (L\_SHIFT + 5)  
ITERATES FIRING BURST LENGTH FOR REAR GUNNER  
SHORT BURST / LONG BURST
- AI PANEL (CREW STATUS) SHOW/HIDE (LWIN+H)  
TURNS AI PANEL (CREW STATUS) ON OR OFF
- ADJUST AUTOPILOT  
TURNS AI AUTOPILOT ON/OFF (RALT+A)
- SHOW GUNNER PANEL  
TOGGLE GUNNER PANEL INTERFACE (RALT+RSHIFT+K)
- SHOW CONTROLS INDICATOR  
TOGGLE CONTROL INDICATOR INTERFACE (RCTRL+ENTER)
- TRACKIR AIMING ON/OFF  
TOGGLE SIDE GUNNER AIMING WITH OR WITHOUT TRACKIR (LALT+T)

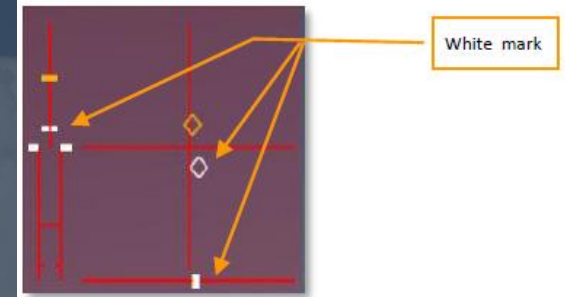
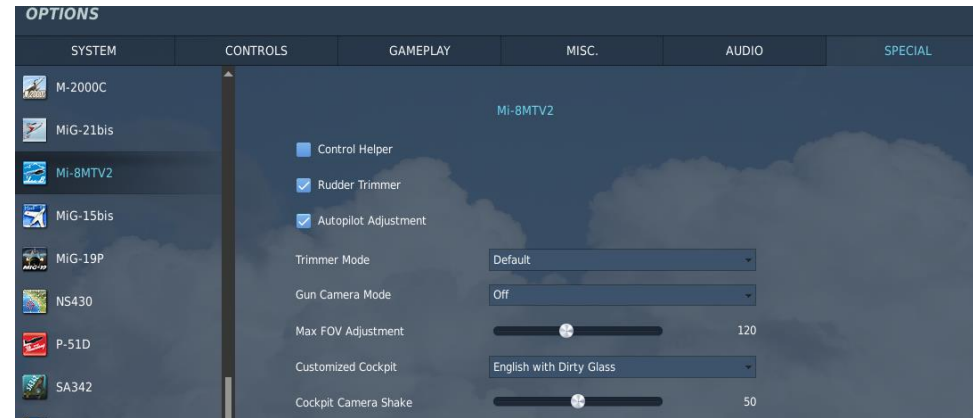

NOTE: These labels are only visible if you have the “Control Helper” options ticked in the “SPECIAL – MI-8” Options tab. Also, the “AI AUTOPILOT” feature will only be available if the “AUTOMATIC ADJUSTMENT” option is checked in the “SPECIAL” Options tab.

# CONTROLS FOR GUNNERS, CREW & INTERFACE MANAGEMENT

In the “Special” tab, make sure [AUTOPILOT ADJUSTMENT, RUDDER TRIMMER](#) and [CUSTOMIZED COCKPIT: ENGLISH](#) options are [selected/ticked](#)! Note that “rudder trimmer” (which is in fact for the anti-torque pedals) is optional and up to your personal taste. The real life Mi-8 has it (pedals remain in place once trimmed) but most rudder pedals we have use springs, which makes rudder trim impractical.

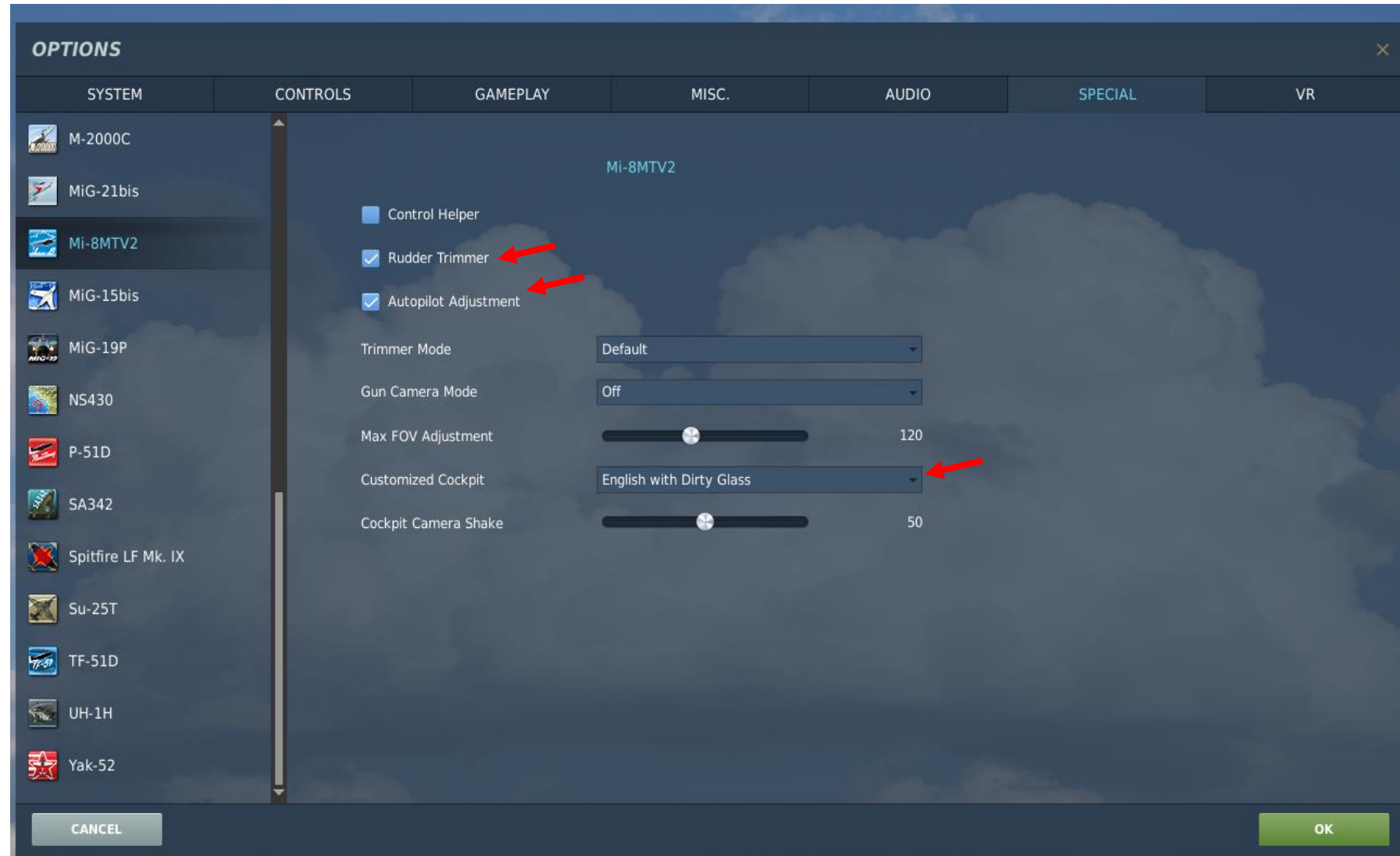



**OPTIONS**

SYSTEM    **CONTROLS**    GAMEPLAY    MISC.    AUDIO    SPECIAL    VR

Mi-8MTV2 Sim    Axis Commands    Reset category to default    Clear category    Save profile as    Load profile

Action	Category	Keyboard	Throttle - HOTAS W...	Joystick - HOTAS Wa...	Saitek Pro Flight Co...	MO
Absolute Camera Horizontal View						
Absolute Camera Vertical View						
Absolute Horizontal Shift Camera View						
Absolute Longitude Shift Camera View						
Absolute Roll Shift Camera View						
Absolute Vertical Shift Camera View						
Autopilot Heading Adjustment						
Autopilot Pitch Adjustment						
Autopilot Roll Adjustment						
Camera Horizontal View						MO
Camera Vertical View						MO
Camera Zoom View						MO
Corrector			JOY_RZ			
Flight Control Collective			JOY_Z		JOY_Z	
Flight Control Cyclic Pitch				JOY_Y		
Flight Control Cyclic Roll				JOY_X		
Flight Control Rudder					JOY_RZ	
Rotor Brake Handle						
TDC Slew Horizontal (mouse)						
TDC Slew Vertical (mouse)						
Throttle Left						
Throttle Right						
Wheel brake						
Zoom View						

Modifiers    Add    Clear    Default    **Axis Assign**    **Axis Tune**    FF Tune    Make HTML

CANCEL    OK

To assign axis, click on Axis Assign. You can also select "Axis Commands" in the upper scrolling menu.

To modify curves and sensitivities of axes, click on the axis you want to modify and then click on "Axis Tune".

## BIND THE FOLLOWING AXES:

- CYCLIC PITCH (DEADZONE AT 3, SATURATION X AT 100, SATURATION Y AT 85, CURVATURE AT 21)
- CYCLIC ROLL (DEADZONE AT 3, SATURATION X AT 100, SATURATION Y AT 85, CURVATURE AT 21)
- RUDDER/ANTI-TORQUE (DEADZONE AT 0, SATURATION X AT 100, SATURATION Y AT 100, CURVATURE AT 14)
- COLLECTIVE (DEADZONE AT 0, SATURATION X AT 100, SATURATION Y AT 100, CURVATURE AT 11)
- THROTTLE (CORRECTOR) – CONTROLS ENGINE RPM

## NOTES ABOUT CONTROLS

If you are more familiar with airplanes than with helicopters, you might not be quite familiar with a “collective” and a “cyclic”. In a prop aircraft, you generally set your engine to a given RPM by changing the propeller’s pitch, and you throttle up and down to change your thrust. Anti-torque pedals are used to change the orientation of your vertical stab.

In a helicopter, it’s the opposite. You set your throttle to a given setting, and you change your thrust with your **collective**, which changes the pitch of your rotor/propeller’s blades. Anti-torque pedals are used to modify your tail rotor’s propeller pitch: the amount of lateral thrust generated by your rotor is in direct relationship with the horizontal/lateral orientation of your helicopter. The **cyclic**, on the other hand, is used just like a regular stick on a plane. The cyclic modifies the orientation of swashplates, to which are attached push rods that define the orientation of the rotor.

In very simple terms, you could say that the collective is used like a throttle on a plane, the throttle is used like a RPM setter on a plane, and the cyclic is used like a joystick on a plane.

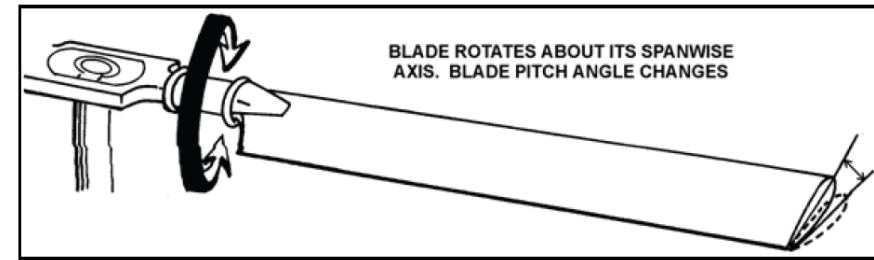

Figure 1-17. Feathering









**Ми-8ТБ «Hip-E»**

1. Ствол 12,7-мм пулемета
2. Носовая подвижная пулеметная установка
3. Нижняя часть остекления кабины
4. Приемник воздушного давления
5. Педали управления (относительно вертикальной оси)
6. Прицел пулеметной установки
7. Стеклоочиститель
8. Панели остекления
9. Аппаратура наведения и управления на рабочем месте второго пилота
10. Верхние панели переключателей
11. Антенны системы распознавания «свой—чужой»
12. Верхний люк кабины
13. Дверь кабины экипажа
14. Щиток радио- и электрооборудования
15. Место второго пилота
16. Откидное сиденье стрелка-радиста
17. Панель приборов
18. Резервный компас
19. Ручка циклического шага
20. Пол кабины экипажа
21. Сдвоенное носовое колесо шасси
22. Ручка «шаг-газ»
23. Ремень безопасности
24. Бронированное кресло пилота
25. Регулировка кресла
26. Сдвижная панель остекления кабины
27. Разъемы подсоединения наземного электропитания и кабелей связи
28. Аккумуляторные батареи
29. Стенка кабины экипажа
30. Короба трасс проводки управления
31. Воздухозаборник двигателя
32. Пылезащитное устройство двигателя
33. Узел фильтра
34. Пустотелый лонжерон лопасти несущего винта
35. Панели задней кромки с сотовым наполнителем

36. Пилон подвески правого борта
37. ПТУР 9М17 «Фаланга» (обозначение в НАТО и США — AT-2 «Swatter»)
38. Капот двигателя
39. Продольная противопожарная перегородка
40. Узлы и агрегаты оборудования двигателя
41. Генератор
42. Воздуховод системы охлаждения
43. Газотурбинный двигатель ТВ2-117А
44. Опора крепления двигателя

45. Складные сиденья правого борта грузовой кабины (нормально в кабине может размещаться до 20 бойцов, с перегрузом — 24)
46. Бортовая стрела с электролебедкой
47. Прорез двери кабины
48. Откидное сиденье левого борта

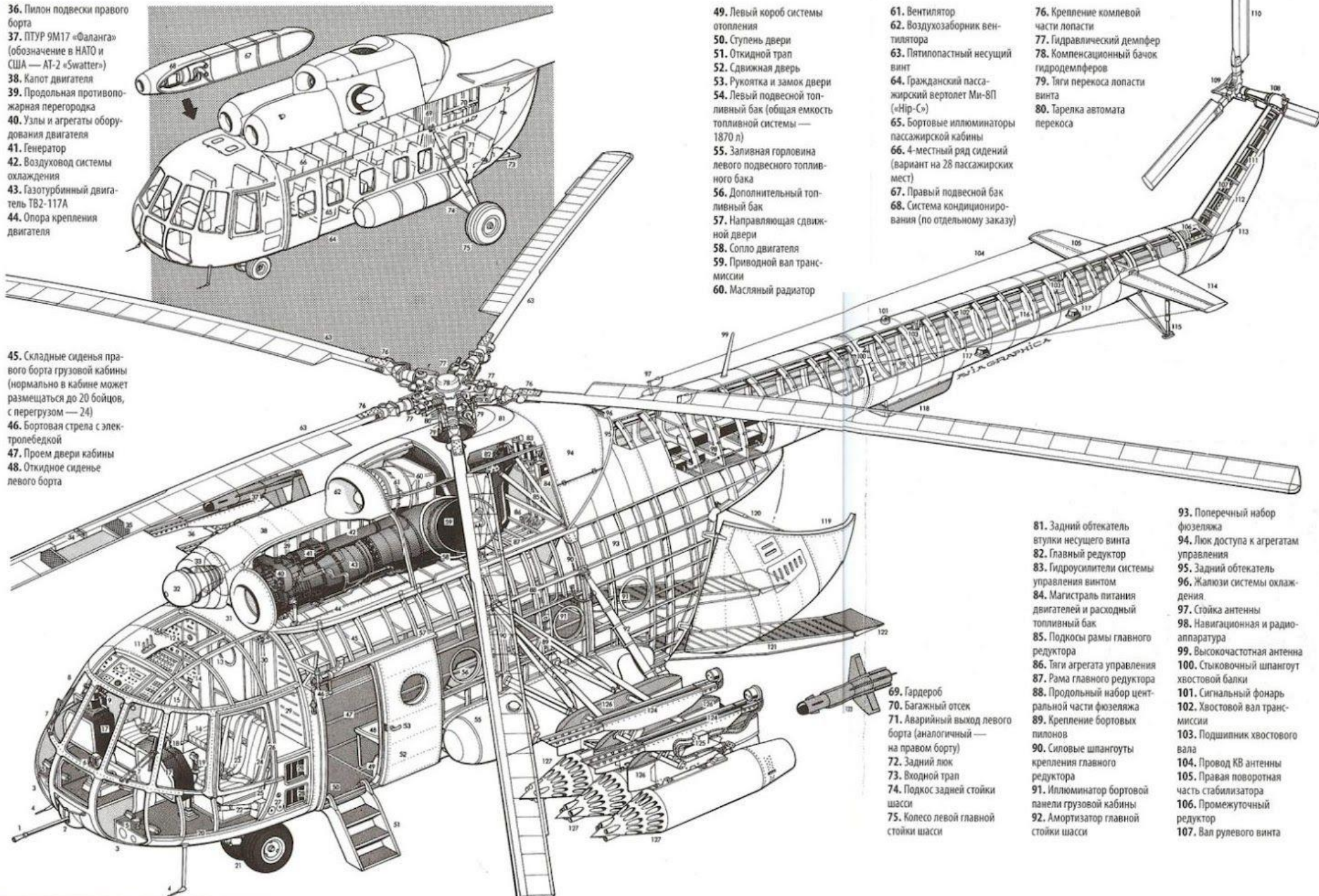

49. Левый короб системы отопления
50. Ступень двери
51. Откидной трап
52. Сдвижная дверь
53. Ручка и замок двери
54. Левый подвесной топливный бак (общая емкость топливной системы — 1870 л)
55. Заливная горловина левого подвесного топливного бака
56. Дополнительный топливный бак
57. Направляющая сдвижной двери
58. Сопло двигателя
59. Приводной вал трансмиссии
60. Масляный радиатор

61. Вентилятор
62. Воздухозаборник вентилятора
63. Пятилопастный несущий винт
64. Гражданский пассажирский вертолет Ми-8П («Hip-C»)
65. Бортовые иллюминаторы пассажирской кабины
66. 4-местный ряд сидений (вариант на 28 пассажирских мест)
67. Правый подвесной бак
68. Система кондиционирования (по отдельному заказу)

76. Крепление комлевой части лопасти
77. Гидравлический демпфер
78. Компенсационный бачок гидродемпферов
79. Тяги перекоса лопасти винта
80. Тарелка автомата перекоса

69. Гардероб
70. Багажный отсек
71. Аварийный выход левого борта (аналогичный — на правом борту)
72. Задний люк
73. Входной трап
74. Подкос задней стойки шасси
75. Колесо левой главной стойки шасси

81. Задний обтекатель втулки несущего винта
82. Главный редуктор
83. Гидроусилители системы управления винтом
84. Магистраль питания двигателей и расходный топливный бак
85. Подкосы рамы главного редуктора
86. Тяги агрегата управления
87. Рама главного редуктора
88. Продольный набор центральной части фюзеляжа
89. Крепление бортовых пилонов
90. Силовые шпангоуты крепления главного редуктора
91. Иллюминатор бортовой панели грузовой кабины
92. Амортизатор главной стойки шасси

93. Поперечный набор фюзеляжа
94. Люк доступа к агрегатам управления
95. Задний обтекатель
96. Жалюзи системы охлаждения
97. Стойка антенны
98. Навигационная и радиоаппаратура
99. Высокочастотная антенна
100. Стыковочный шпангоут хвостовой балки
101. Сигнальный фонарь
102. Хвостовой вал трансмиссии
103. Подшипник хвостового вала
104. Провод КВ антенны
105. Правая поворотная часть стабилизатора
106. Промежуточный редуктор
107. Вал рулевого винта



## SEAT SELECTION CONTROLS

Pilot: 1  
CoPilot: 2  
Flight Engineer: 3  
Side Gunner: 4



Copilot  
Navigator

Flight Engineer  
Crew Chief

Pilot Commander



**SIDE GUNNER**  
**12.7 MM KORD MACHINEGUN**

- SEAT SELECTION CONTROLS**
- Pilot: 1
  - CoPilot: 2
  - Flight Engineer: 3
  - Side Gunner: 4



**REAR GUNNER**  
**(NOT SELECTABLE)**  
**7.62 MM PKT MACHINEGUN**





### **DOOR CONTROLS**

Left Door: L\_Ctrl+L\_Shift+C  
Left Blister Door: L\_Ctrl+C  
Right Blister Door: L\_Shift+C  
Cargo Doors: L\_Alt+L\_Ctrl+C







PART 3 - COCKPIT & GAUGES











Window Handle

Visual Ice Detector  
*Indicates ice accumulation*

Mirror





Рис. 9.51. Pilot's (left) collective control group:

1 – hand wheel (friction adjust); 2 – engine condition levers (ECLs); 3 – twist throttle; 4 – Emerg cargo release button; 5 – N2 trim INCR-DEC switch; 6 – searchlight control button; 7 – tactical external stores jettison button; 8 – CLUTCH RELEASE button.



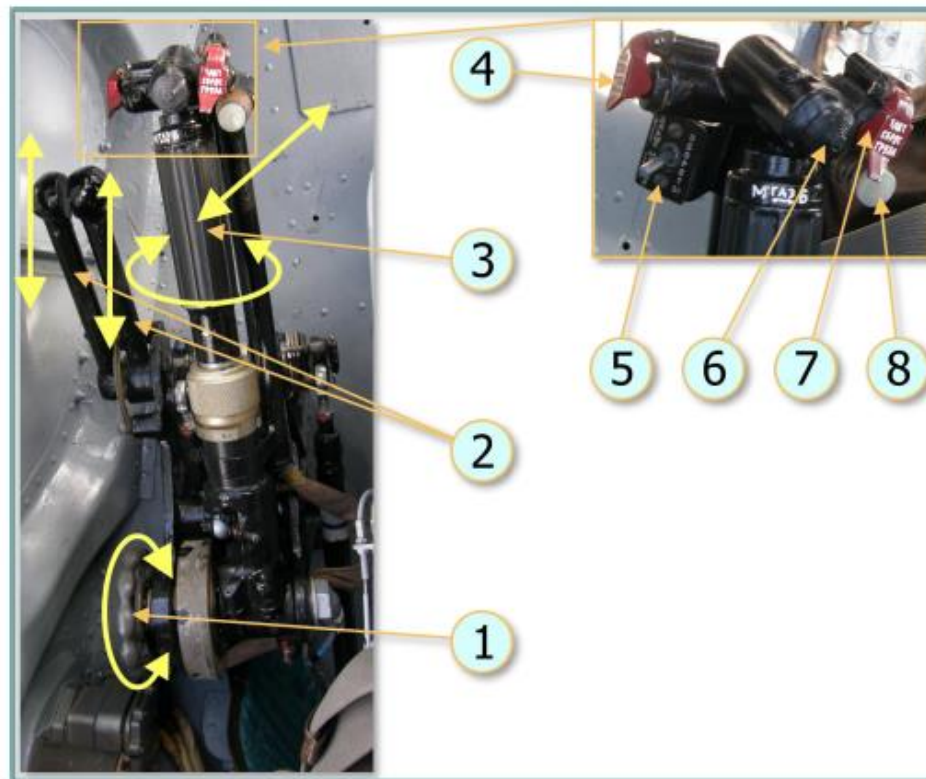
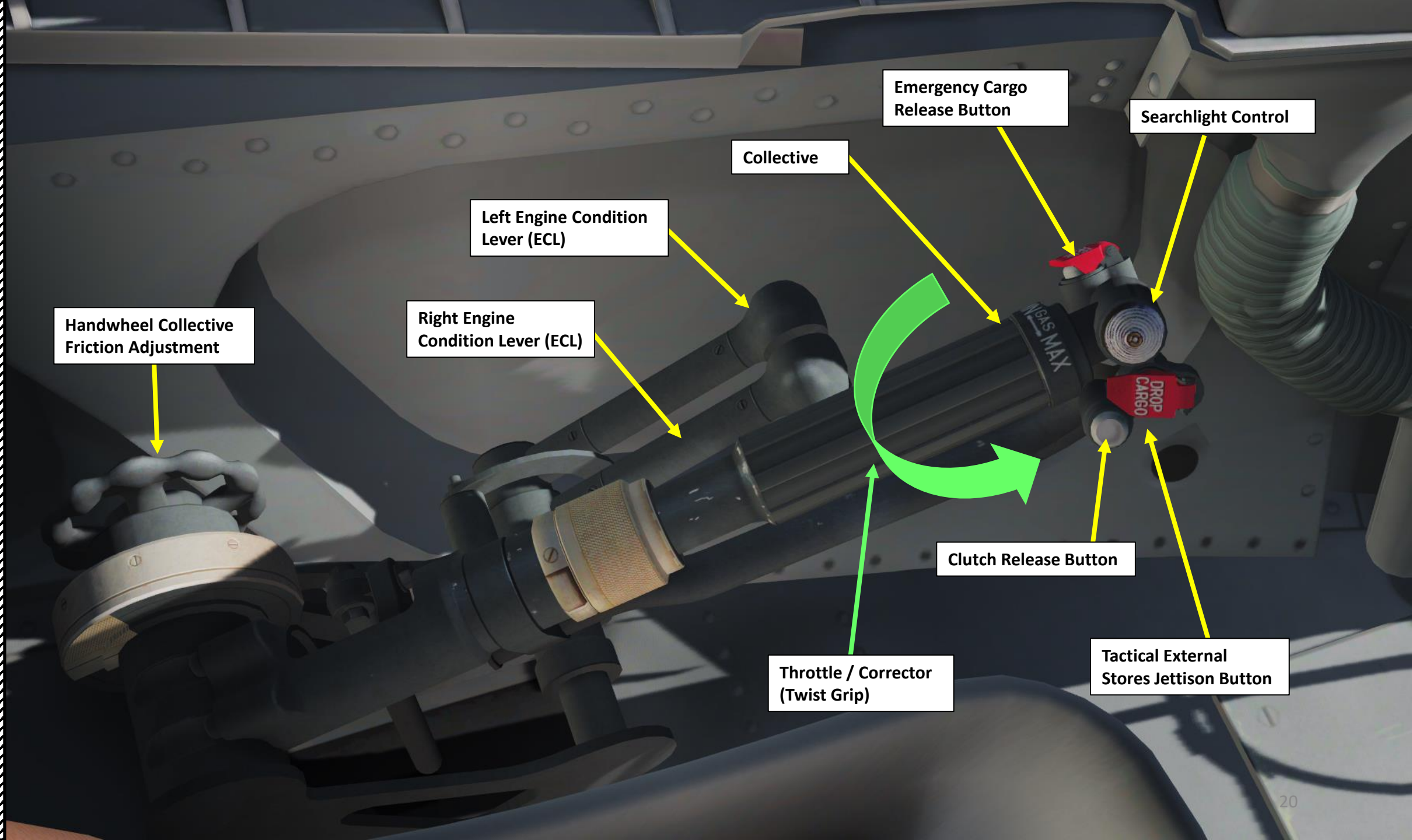

Handwheel Collective Friction Adjustment

Right Engine Condition Lever (ECL)

Left Engine Condition Lever (ECL)

Collective

Throttle / Corrector (Twist Grip)

Emergency Cargo Release Button

Clutch Release Button

Searchlight Control

Tactical External Stores Jettison Button





**Rotor Brake Lever**  
FWD: DISENGAGED  
AFT: ENGAGED



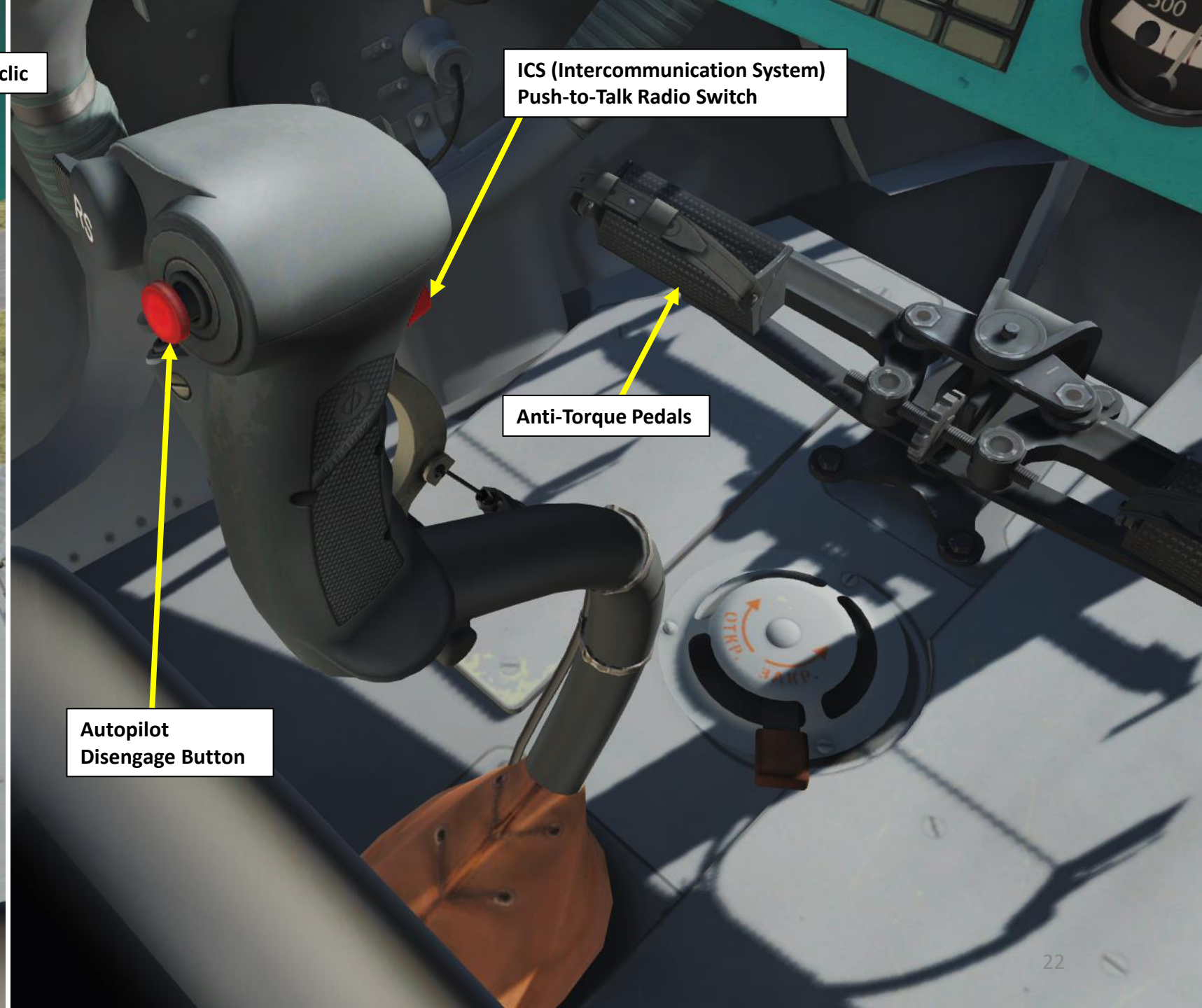
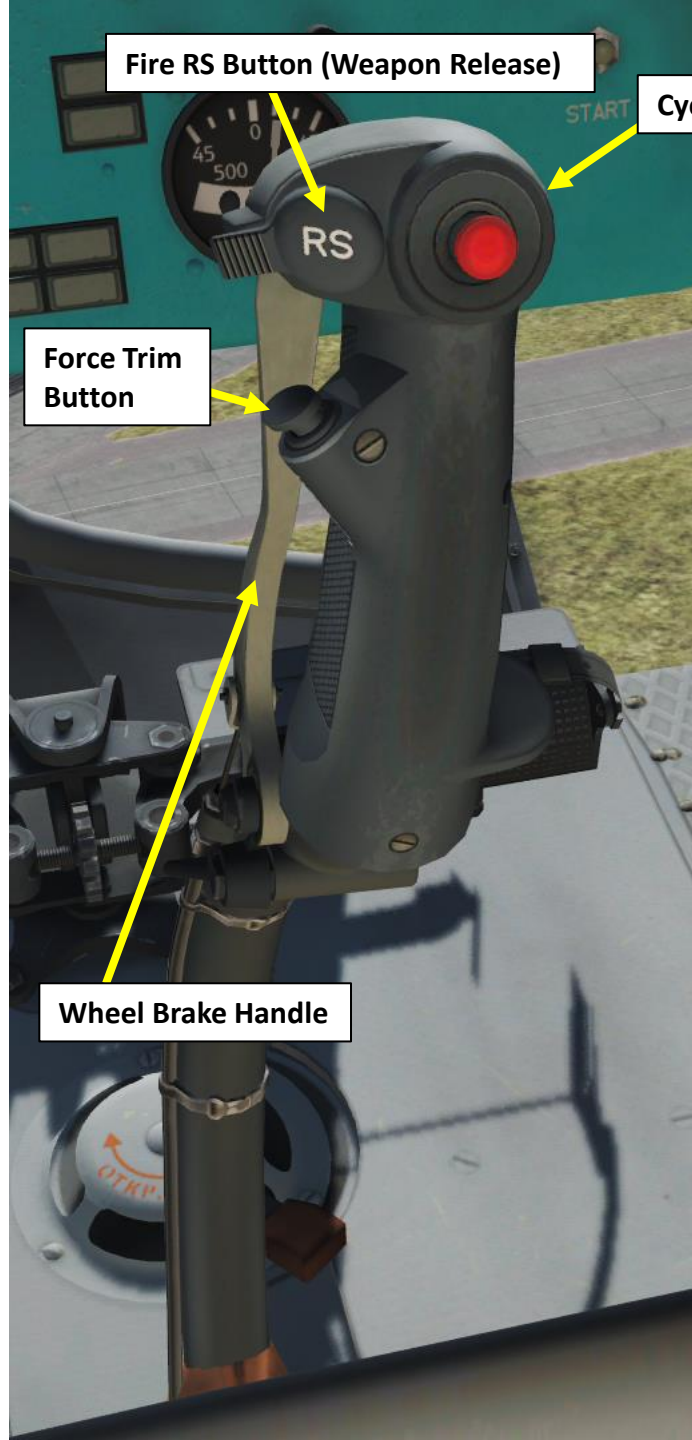



Signal Flare Cassette 1 Power Switch

Signal Flare Launch Switches

Signal Flare Cassette 2 Power Switch

Left Side Red Interior Lights  
Brightness Controls

REPEAT AMP  
OFF TEST OFF

ERASE FAILURE

Left & Right Engine Temperature  
Regulator Operating Annunciators

RI-65B Voice Warning System  
Remote Control Panel

Engine Vibration Indicator  
Test Switch

AIR BRAKE  
CODE-NAV LTS HORN AUTO RELEASE  
EXTERNAL LOAD

Flight Data Recorder ON Annunciator

EGT gauge Ground / Air  
Test Switches

Left/Right Engine Temperature  
Regulator Test Switches

Flight Data Recorder Power Switch







Countermeasure Dispensers

Signal Flare Dispenser Cassettes



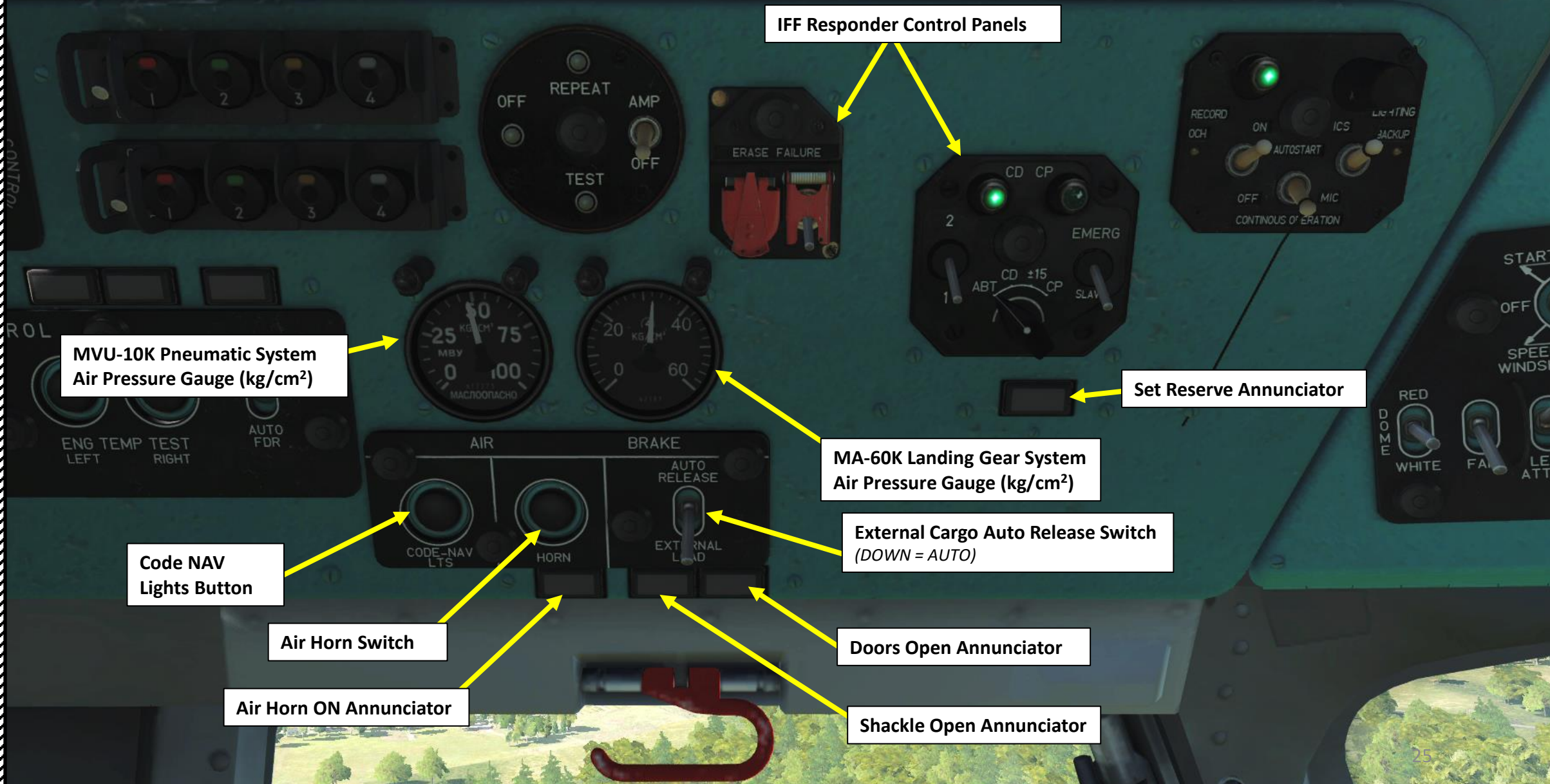

IFF Responder Control Panels

MVU-10K Pneumatic System  
Air Pressure Gauge (kg/cm<sup>2</sup>)

Set Reserve Annunciator

MA-60K Landing Gear System  
Air Pressure Gauge (kg/cm<sup>2</sup>)

External Cargo Auto Release Switch  
(DOWN = AUTO)

Code NAV  
Lights Button

Air Horn Switch

Air Horn ON Annunciator

Doors Open Annunciator

Shackle Open Annunciator



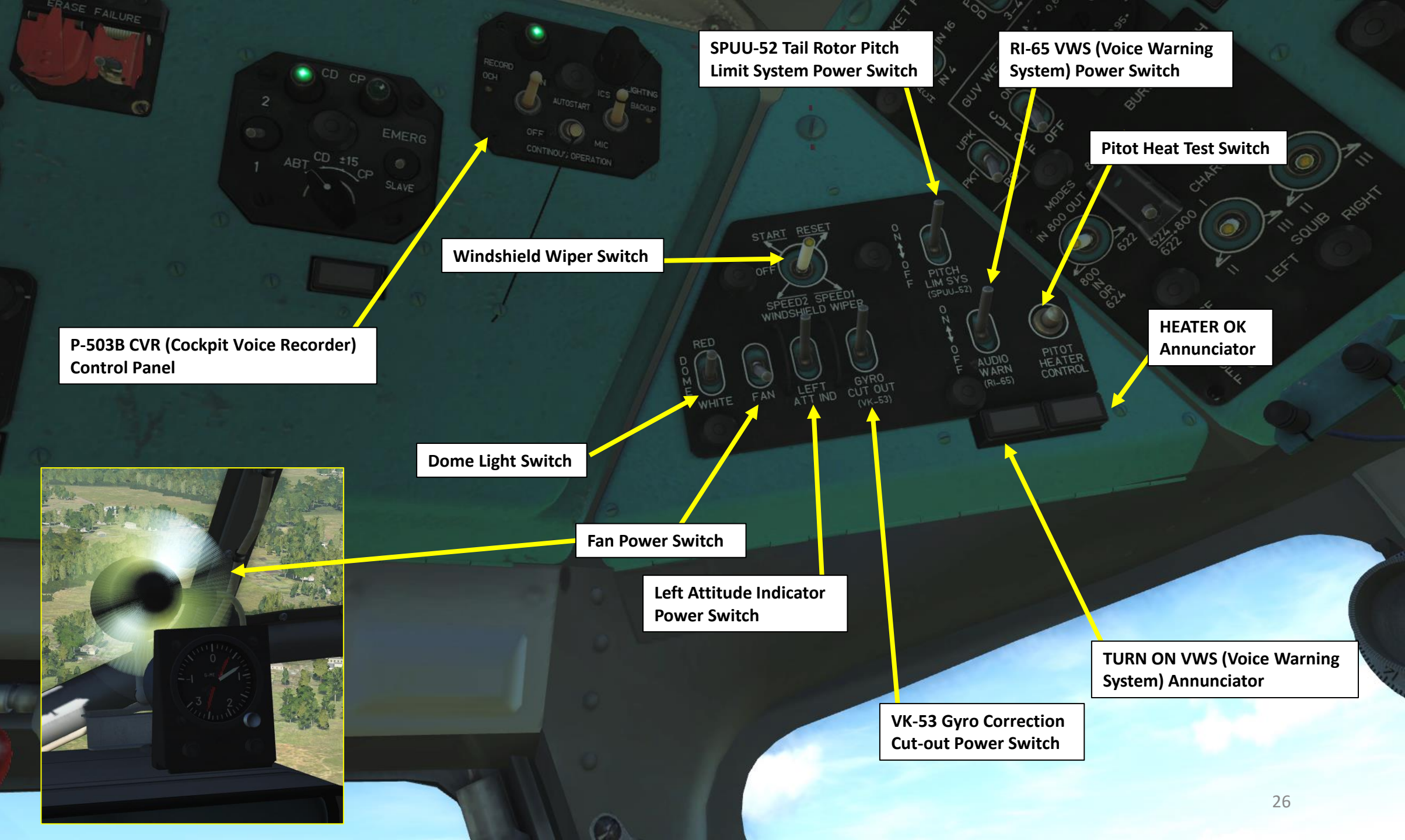

P-503B CVR (Cockpit Voice Recorder) Control Panel

Windshield Wiper Switch

SPUU-52 Tail Rotor Pitch Limit System Power Switch

RI-65 VWS (Voice Warning System) Power Switch

Pitot Heat Test Switch

HEATER OK Annunciator

Dome Light Switch

Fan Power Switch

Left Attitude Indicator Power Switch

VK-53 Gyro Correction Cut-out Power Switch

TURN ON VWS (Voice Warning System) Annunciator





**Rocket Station Selector Switch**  
1-2-5-6: Inner & Outer Stations  
ABT: AUTO (all stations)  
3-4: Middle Stations

**Rocket Burst Quantity Selector**  
8/16/4 rockets per burst

**GUV Gunpod Fire Burst Cutoff Switch**  
UP: Burst Firing Mode ON  
DOWN: Burst Firing Mode OFF

**Weapon Selector Switch**  
TOP: UPK 23 mm cannon  
MIDDLE: PKT nose machine-gun (not functional)  
DOWN: RKT/PC 80 mm rockets

**GUV gun pod burst length (in seconds)**  
Ex: 0.40 is a burst length of 0.40 seconds

**GUV gun pod Firing Mode Selectors**  
800: 30 mm grenade launcher  
(outer stations)  
800/624: GShG-12.7 mm mg pods  
or 30 mm grenade launcher if equipped  
622: GShG-7.62 mm machine-gun

**Gun Camera Switch**

**Left YakB-12.7 mm Gun Reload**  
(I = armed)

**Right YakB-12.7 mm Gun Reload**  
(I = armed)

**R-863 VHF Radio FM/AM Selector Switch**  
UP = FM, DOWN = AM

**R-863 VHF Radio Channel Selector**

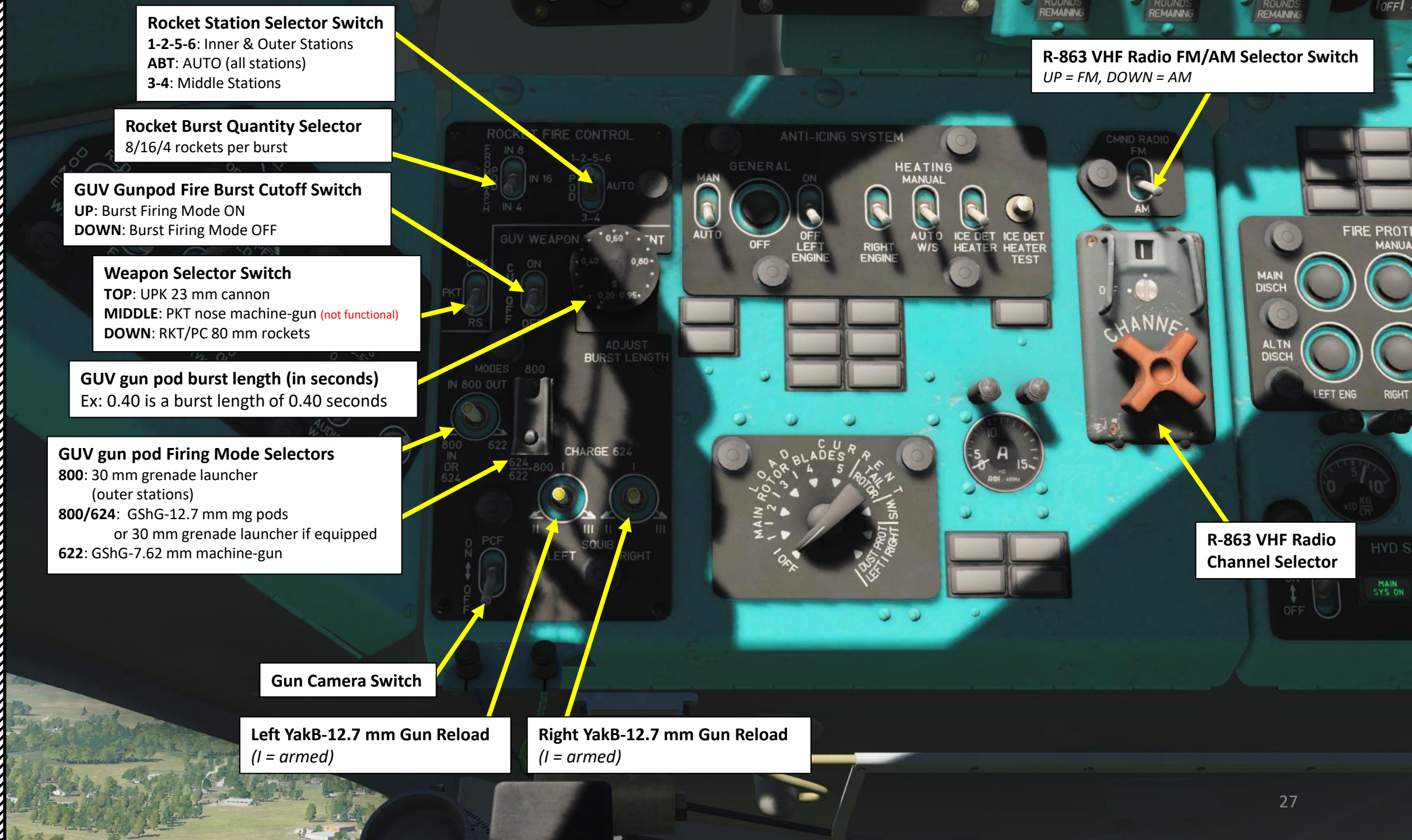



Right Engine Anti-Ice Heater Switch

Glass Heater Switch

Left Engine Anti-Ice Heater Switch

Ice Detector Heater Switch

Defrost Mode Switch  
*Manual/Auto*

Ice Detector Heater Test Button

Defrost OFF Pushbutton

Icing Detected Annunciator

Ice Detector Heater Normal Operation Annunciator

Anti-Ice System ON Annunciator

Right Engine Anti-Ice ON Annunciator

Left Engine Anti-Ice ON Annunciator  
*Indicates valve controlling supply of hot air to the left engine air intake is open*

Right Dust Protection Forward Device Annunciator

Left Dust Protection Forward Device Annunciator  
*Indicates valve controlling supply of hot air to the left engine dust protection device is open*

Right Dust Protection Aft Device Annunciator

Left Dust Protection Aft Device Annunciator

AF1-150 Ammeter

Ammeter Load Current Selector Switch

Anti-Ice Section Test Annunciators  
*Indicates the section of the main rotor blade Anti-Icing system being tested.*

- Top Left: Section 1
- Top Right: Section 3
- Bottom Left: Section 2
- Bottom Right: Section 4

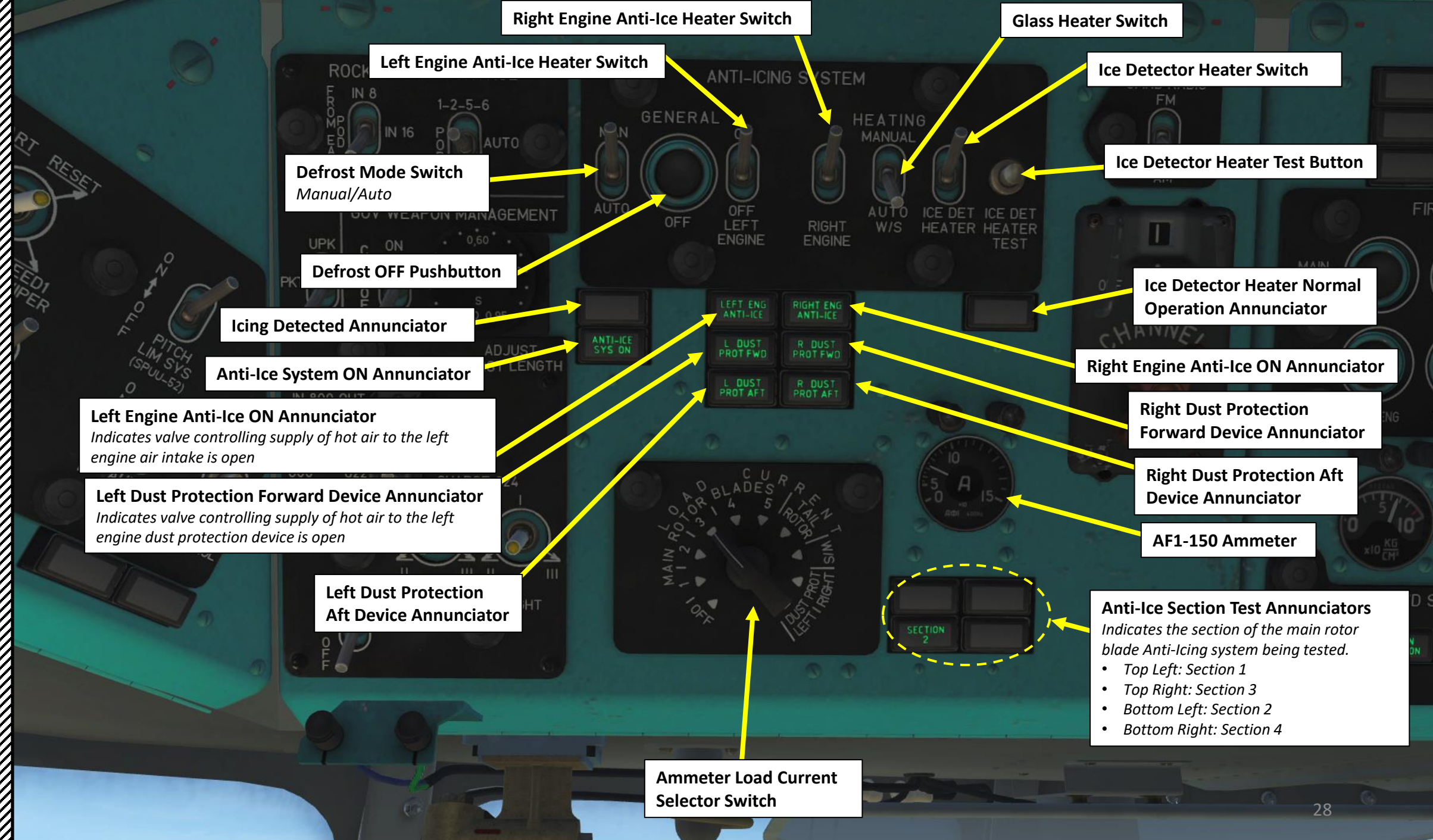



**Radio Selector**  
 "УКР" (UHF) – R-863 UHF/VHF radio set  
 "СР" (HF) – YaDRO-1A radio set  
 "КР" (VHF) – R-828 LVHF radio set  
 "ДР" (SW) – not utilized  
 "PK 1" (ADF) – ARK-9 ADF set  
 "PK 2" (SAR) – ARK-UD VHF homing set

**Aiming Correction Table**

**Jettison All Stores Switch**  
**Jettison "Explode" Switch**  
 UP: Bombs ARMED  
 DOWN: OFF

**Minelaying System Arm**  
 (not funct.)

**PUS Fire Control Power Switch**

**Main Weapons Power Switch**

**Radio Monitor Volume**

**Radio Master Volume**

Дц М	Vnp KM/ч	ФПРИЦЕЛ с-вод-с-эко гориз. полет	РАКУРС ЦЕЛИ	Vц KM/ч	Эц с-эм с-эфф с-эко	ε	330°	
							КМ	С-эм с-эфф с-эко
1500	100	90	1/4	15	1	30°; 150°; 210°;	5	5
	150	80		30	4			
	200	64		45	6			
	250	20		60	8			
2000	270	10	2/4	75	10	30°; 120°;	5	8
	100	100		15	4			
	150	90		30	8			
	200	76		45	12			
2500	250	32	3/4	60	16	60°; 240°;	15	25
	270	20		75	20			
	100	114		15	6			
	150	104		30	12			
3000	200	90	4/4	45	18	90°; 270°;	10	19
	250	44		60	24			
	270	32		75	30			
	100	128		15	8			
3500	150	118		30	16		15	29
	200	104		45	24			
	250	58		60	32			
	270	46		75	40			

EMERGENCY CONDITION

EXPLODE

BOMB POD RELEASE

MASTER POWER OFF

FIRE TEST UNIT ARM

LAMP CHECK

GUV INNER 622

GUV 624-800

GUV OUTER 800

MAIN SWITCH

BOMB ARMAMENT

BOMB RLSE

ARMED

CONTROL

NORMAL

**Weapons Control Panel Lamp Test**

**Ammo Empty Lamp**

**СЕТЬ 1-2  
NET 1-2**

**Emergency Transmission Switch**

**ICS/Radio Selector**  
 СПУ: ICS Intercomm Switch  
 РАД: RADIO

**GUV Gun Pod  
7.62 mm ammo counter**

**Left UPK/GUV Gun Pod  
ammo counter**

**Right UPK/GUV Gun Pod  
ammo counter**

**Gunsight  
Brightness Control**

ROUNDS REMAINING

ROUNDS REMAINING

ROUNDS REMAINING

SIGHT LIGHT

ON

OFF

ELEC TRIGGER

800.9-A-624

LEFT

RIGHT

PKT

EN

BO

P



RACK 4 LOADED Annunciator

RACK 5 LOADED Annunciator

RACK 3 LOADED Annunciator

RACK 6 LOADED Annunciator

RACK 2 LOADED Annunciator

RACK 1 LOADED Annunciator

Jettison ARMED Annunciator

Fire Extinguisher 1 ARMED Annunciator

Gun CCT (Electrical Circuit) ON Annunciator

Gun Camera ON Annunciator

Fire Extinguisher 3 ARMED Annunciator

Fire Extinguisher 3 ARMED Annunciator

Fire Extinguisher 4 ARMED Annunciator

Rocket CCT (Electrical Circuit) ON Annunciator

EMERGENCY CONDITION

EXPLODE BOMB POD RELEASE

MASTER POWER OFF

FIRE TEST UNIT ARM

GUV INNER 622

GUV OUTER 624-800

GUV OUTER 800

LAMP CHECK

SIGHT LIGHT

ROUNDS REMAINING

ROUNDS REMAINING

ROUNDS REMAINING

Дц М	Впр КМ	ФПР с-эко гориз.полет	РАКУРС ЦЕЛИ	Вц КМ	Ец	С	Вв КМ	Ев с-эко
100	90		15	1			5	5
150	80		30	4				
200	6		45	6				
250	20		60	10			10	10
270	10		75	10				
150	100		15	4			5	15
150	90		30	8				
200	76		45	12			5	8
250	20		60	16				
270	20		75	20			10	17
100	114		15	6				
150	104		30	12			15	25
200	90		45	18				
250	44		60	24			5	10
270	3		75	30				
100	128		15	8				
150	118		30	16			10	19
200	104		45	24				
250	58		60	32			15	29
270	46		75	40				

Дц - дальность до цели; Впр - скорость полета; Вц - скорость движ. цели; Ец - скорость ветра; С - поправка на ветер; Вв - поправка на движ. цели; Ев - бортовой угол ветра

BOMB ARMAMENT

ROCKET ARMAMENT

ON 311

OFF

GUV OUTER 800 LEFT

GUV OUTER 800 RIGHT

GUV LFT INNER 9-A-622 LEFT

GUV RGT INNER 9-A-622 RIGHT

GUV RGT OUTER 9-A-622 LEFT

ON

OFF

ELEC TRIGGER 800, 9-A-624 LEFT | RIGHT

PKT

EMERGENCY RELEASE BOMBS | JETTISON | ARMED | POWER

VOLUME

L

R-863

2 W C B RADIO



Weapons Master Arm Handle



Master Arm Light  
RED = ARMED



Engine Stop Lever  
Left Engine



Engine Stop Lever  
Right Engine



Дл	Впр	Средняя	Максимальная	Вд	Ед	С	Вд	Ед
М	км/ч	км/ч	км/ч	км	км	°	км	км
1500	160	90	15	1			5	5
	150	80	30	4				
	200	64	45	6				
	250	20	60	8			10	10
	270	10	75	10				
	100	100	15	4			15	15
	150	90	30	8				
	200	76	45	12				
	250	32	60	16			5	8
	270	20	75	20				
2000	100	114	15	6			10	17
	150	104	30	12				
	100	90	45	18			15	25

EMERGENCY CONDITION

EXPLODE BOMB POD RELEASE

MASTER POWER OFF FIRE TEST UNIT ARM

GUV INNER 622 624-800 800

GUV OUTER 800

LAMP CHECK

31





PKV Gunsight

PKV Gunsight Range  
Setter (x 10 m)

Cockpit Fan

Magnetic Compass





**PART 3 - COCKPIT & GAUGES**



Accelerometer (g)

Current Acceleration

Maximum Acceleration

Accelerometer Reset Button



Taxi Light Switch

Left Landing Light Switch  
UP: LIGHT ON  
MIDDLE: OFF  
DOWN: RETRACT

Static Pressure System Mode  
LEFT/COMMON/RIGHT





**Barometric Pressure (mm Hg)**

**Bomb Sight Course Indicator**

**Barometric Setting Knob**

**Hover and Low Speed Control Indicator**

**Barometric Altimeter**  
Short needle: 1000 m  
Long needle: 100 m

**HSI: Horizontal Situation Indicator**

**Radar Altimeter Indicator (m)**

**Radar Altimeter Power**  
UP: ON / DOWN: OFF

**Main Rotor Tachometer (% max RPM)**

**Main Rotor Pitch Angle (deg)**

**EPR: Engine Pressure Ratio**  
Amber Index: Current Power Setting  
O (T) Index: Takeoff Power Setting  
H (M) Index: Nominal Power Setting  
K (C) Index: Cruise Power Setting

**HSI selector**  
ARK-9 (MW) / ARK-UD (VHF)

**Vertical Velocity Indicator (m/s)**



**Engine N1 (Gas Turbine/Compressor Speed) Indicator (% max RPM)**

**PTIT (Power Turbine Inlet Temperature) Indicator (x100 deg C)**

**Airspeed Indicator (x10 km/h)**

**Attitude Indicator**

**Slip Indicator**

**Turn & Bank Indicator**

**UV-26 Countermeasure Dispenser**



Left Engine Free Turbine Overspeed Annunciator	Right Engine Free Turbine Overspeed Annunciator	Left Engine Low Oil Pressure Annunciator	Right Engine Low Oil Pressure Annunciator
Emergency Power Left Engine Annunciator	Emergency Power Right Engine Annunciator	Electronic Control Left Engine OFF (GOV PWR) Annunciator	Electronic Control Right Engine OFF (GOV PWR) Annunciator

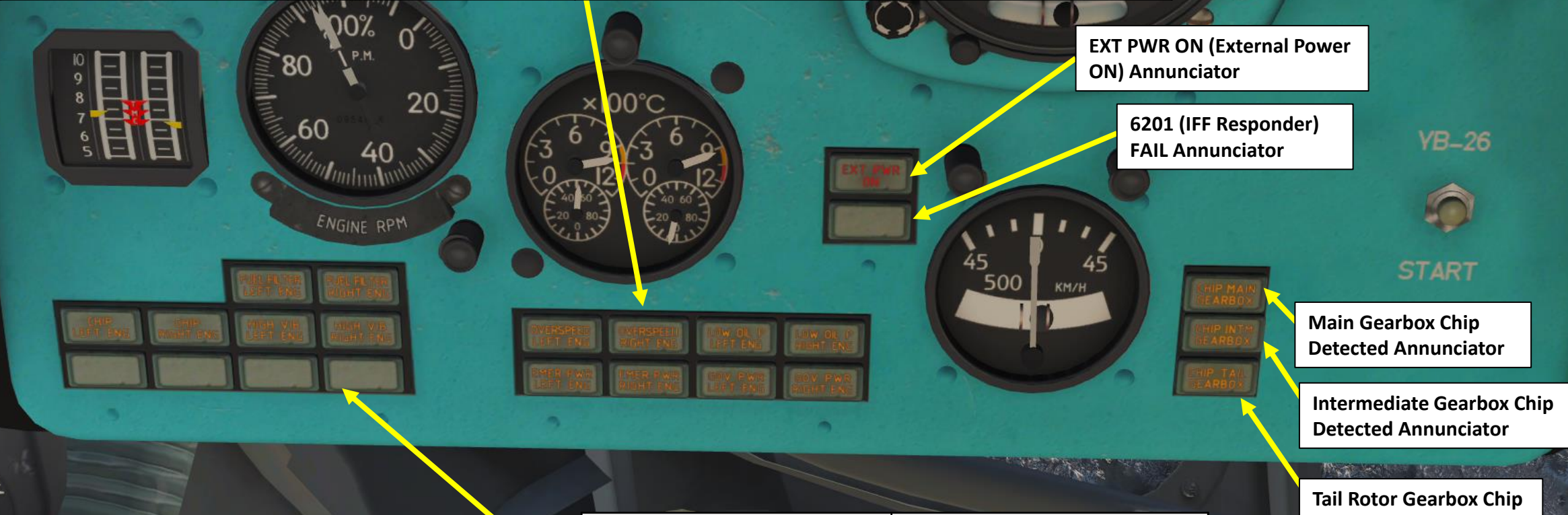

Left Engine Oil Chip Detected Annunciator	Right Engine Oil Chip Detected Annunciator	Left Engine Fuel Filter Clogging Detected Annunciator	Right Engine Fuel Filter Clogging Detected Annunciator
Fire Detected Annunciator	Spare Annunciator (Not Used)	Left Engine Abnormal Vibration Detected Annunciator	Right Engine Abnormal Vibration Detected Annunciator
FIRE Annunciator		Left Engine Excursion Limit Vibration Annunciator	Right Engine Excursion Limit Vibration Annunciator
		STOP LEFT ENGINE Annunciator	STOP RIGHT ENGINE Annunciator



**PART 3 – COCKPIT & GAUGES**

MI-8MTV2  
HIP



SAFETY LOCKS

CIRCUIT BREAKER

Intercom Control Panel

Central Red Interior Lights Brightness Controls



TOP: Main Transmission Gearbox Oil Pressure (kg/cm<sup>2</sup>)  
LEFT: Intermediate Gearbox oil temperature (deg C)  
RIGHT: Tail Rotor Gearbox oil Temperature (deg C)

Main Transmission Gearbox  
Oil Temperature (x10 deg C)

Left engine oil pressure (kg/cm<sup>2</sup>)

Right engine oil pressure (kg/cm<sup>2</sup>)

Right engine oil temperature (deg C)

Left engine oil temperature (deg C)





**Trim Indicator Panel of Automatic Flight Control System (AFCS)**

**Autopilot Altitude Mode Button**  
GREEN = ON  
RED = OFF

**SPUU-52 Tail Rotor Pitch Limit System Indicator**

**Engage SPUU-52 Tail Rotor Pitch Limit System**  
Uses a linear actuator linked to a mechanical stop to adjust the maximum tail rotor blade pitch angle within a range of 16°20' to 20°30'. The adjustment is based on air temperature and density:

- increased density (low altitude or/and low temperature) results in a decrease in the maximum blade pitch angle,
- decreased density (high altitude or/and high temperature) results in a increase in the maximum blade pitch angle.

**Autopilot Pitch & Roll Mode Button**  
GREEN = ON

**SPUU-52 Control Adjustment**

**R-863 VHF radio preset / manual selector**  
UP = PRESET, DOWN = MANUAL

**Autopilot Heading Mode Button**  
GREEN = ON  
RED = OFF

**SPUU-52 Left/Right Control P/t**

**R-863 VHF Radio Squelch (noise suppression)**

**Autopilot Yaw / Roll / Pitch Controls**

**36V Instrument Transformer Switch**  
UP: MAIN  
MIDDLE: OFF  
DOWN: STANDBY

**Autopilot Altitude Control**  
Left Click = DOWN  
Right Click = UP

**R-863 VHF Radio Frequency Indicators**

**Emergency Rectifier Bypass Switch**

**Warning Lights Check Switch**

**R-863 VHF Radio Frequency Tuners**



**CT (Compressor Turbine) Check Switch**

- UP: RH TC (Right Compressor Turbine/N1) Test
- MIDDLE: Normal Operation
- DOWN: LH TC (Left Compressor Turbine/N1) Test

**Left Engine ER (Emergency Power) Switch**

**Left Engine EEG (Engine Electronic Governor) Switch**

**Right Engine ER (Emergency Power) Switch**

**Right Engine EEG (Engine Electronic Governor) Switch**

**Left Engine FT (Free Power Turbine/N2) Check Switch**

- UP: FT1 / Test 1
- MIDDLE: Normal Operation
- DOWN: FT2 / Test 2

**Right Engine FT (Free Power Turbine/N2) Check Switch**

- UP: FT1 / Test 1
- MIDDLE: Normal Operation
- DOWN: FT2 / Test 2

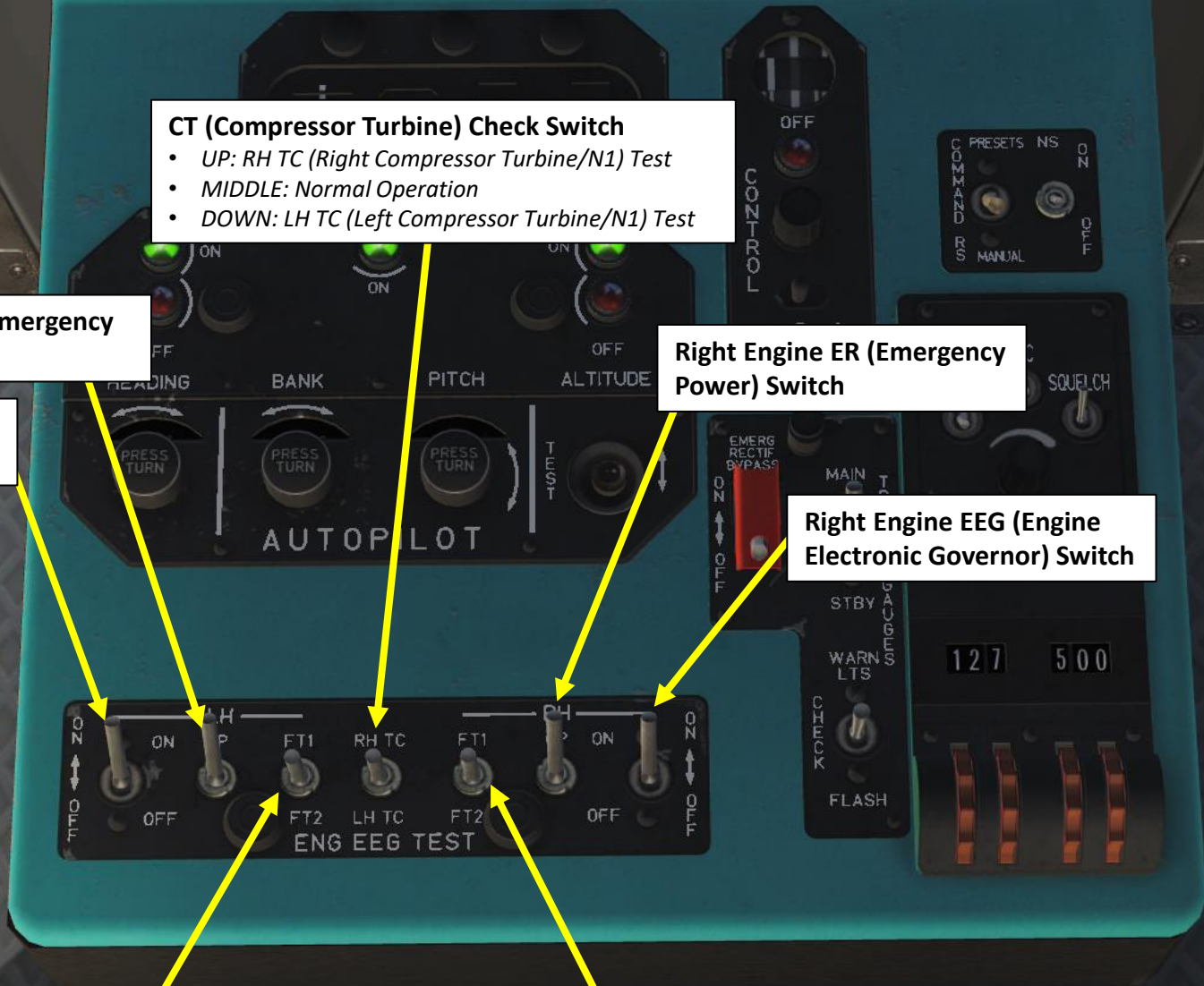



Weapon Systems  
Circuit Breakers

Engine, Electrical, Navigation & Radio Systems  
Circuit Breakers

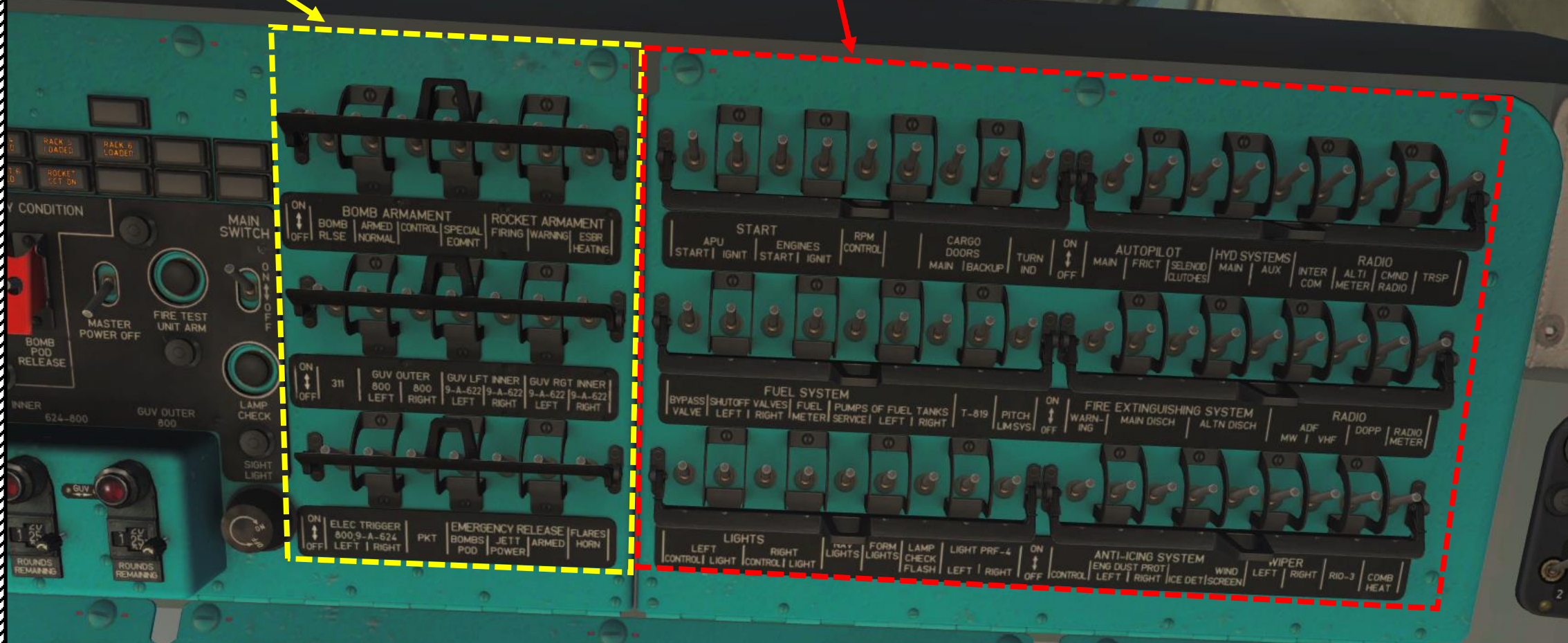



Main Fire Extinguisher  
KO-50 Heater

Main Fire Extinguisher  
Discharge Button / Right Engine

Main Fire Extinguisher Discharge  
Button / APU (Auxiliary Power Unit)

Fuel Crossfeed Valve  
Switch

Main Fire Extinguisher  
Discharge Button / Left Engine

Fuel Shutoff Valve  
Switch / Right Engine

Bypass Valve Switch

Fire Signal  
OFF Button

Fuel Shutoff Valve  
Switch / Left Engine

FIRE PROTECTION SYSTEM  
MANUAL DISCHARGE

MAIN DISCH  
ALTN DISCH

LEFT ENG  
RIGHT ENG  
COMBUST  
APUGEAR

FIRE WARN  
OFF

FIRE DET

Alternate Fire Extinguisher  
Discharge Button / APU Gear

EGT APU AIR PRESS

FUEL SYSTEM  
SHUT-OFF VALVES  
LEFT RIGHT CROSS  
FEED BYPASS

Alternate Fire Extinguisher  
Discharge Button / Right Engine

Alternate Fire Extinguisher  
Discharge Button / KO-50 Heater

Alternate Fire Extinguisher  
Discharge Button / Left Engine

Refueling  
Control Switch

Service Tank Fuel  
Pump Switch

Fuel Pump Switch  
Left Engine

Fuel Pump Switch  
Right Engine

REFUEL TANK PUMPS

CHECK SERVICE LEFT RIGHT

SERVICE PUMP ON

COMBUST HEATER

MAN PRIMING  
FULL RATE MED RATE

AUTO



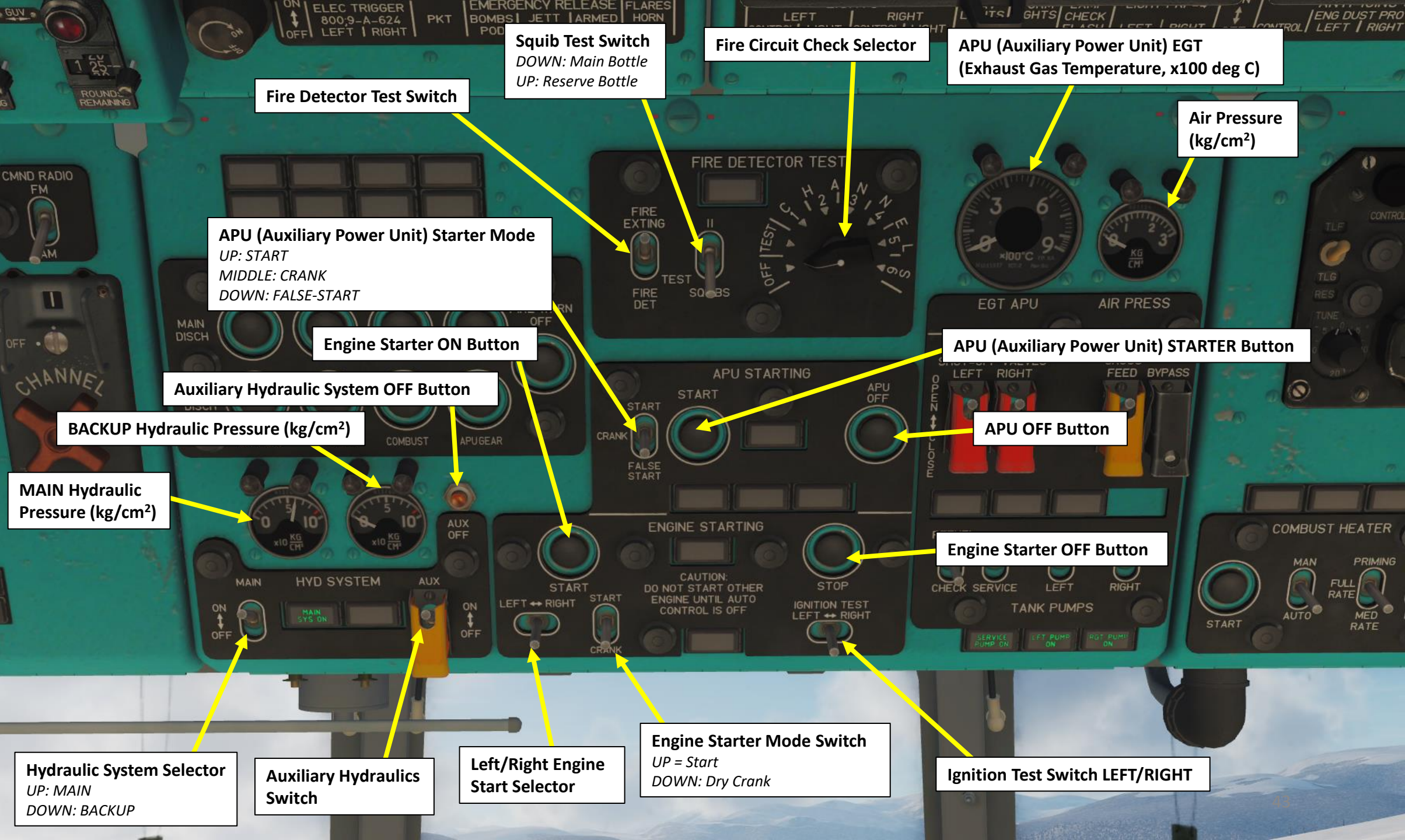

**Fire Detector Test Switch**

**Squib Test Switch**  
DOWN: Main Bottle  
UP: Reserve Bottle

**Fire Circuit Check Selector**

**APU (Auxiliary Power Unit) EGT**  
(Exhaust Gas Temperature, x100 deg C)

**Air Pressure**  
(kg/cm<sup>2</sup>)

**APU (Auxiliary Power Unit) Starter Mode**  
UP: START  
MIDDLE: CRANK  
DOWN: FALSE-START

**Engine Starter ON Button**

**Auxiliary Hydraulic System OFF Button**

**BACKUP Hydraulic Pressure (kg/cm<sup>2</sup>)**

**MAIN Hydraulic Pressure (kg/cm<sup>2</sup>)**

**APU (Auxiliary Power Unit) STARTER Button**

**APU OFF Button**

**Engine Starter OFF Button**

**Hydraulic System Selector**  
UP: MAIN  
DOWN: BACKUP

**Auxiliary Hydraulics Switch**

**Left/Right Engine Start Selector**

**Engine Starter Mode Switch**  
UP = Start  
DOWN: Dry Crank

**Ignition Test Switch LEFT/RIGHT**



Left Engine FIRE Annunciator	Right Engine FIRE Annunciator	KO-50 Heater FIRE Annunciator	APU FIRE Annunciator
Main Fire Extinguisher Left Engine Annunciator	Main Fire Extinguisher Right Engine Annunciator	Main Fire Extinguisher KO-50 Heater Annunciator	Main Fire Extinguisher APU Annunciator
Alternate Fire Extinguisher Left Engine Annunciator	Alternate Fire Extinguisher Right Engine Annunciator	Alternate Fire Extinguisher KO-50 Heater Annunciator	Alternate Fire Extinguisher APU Annunciator

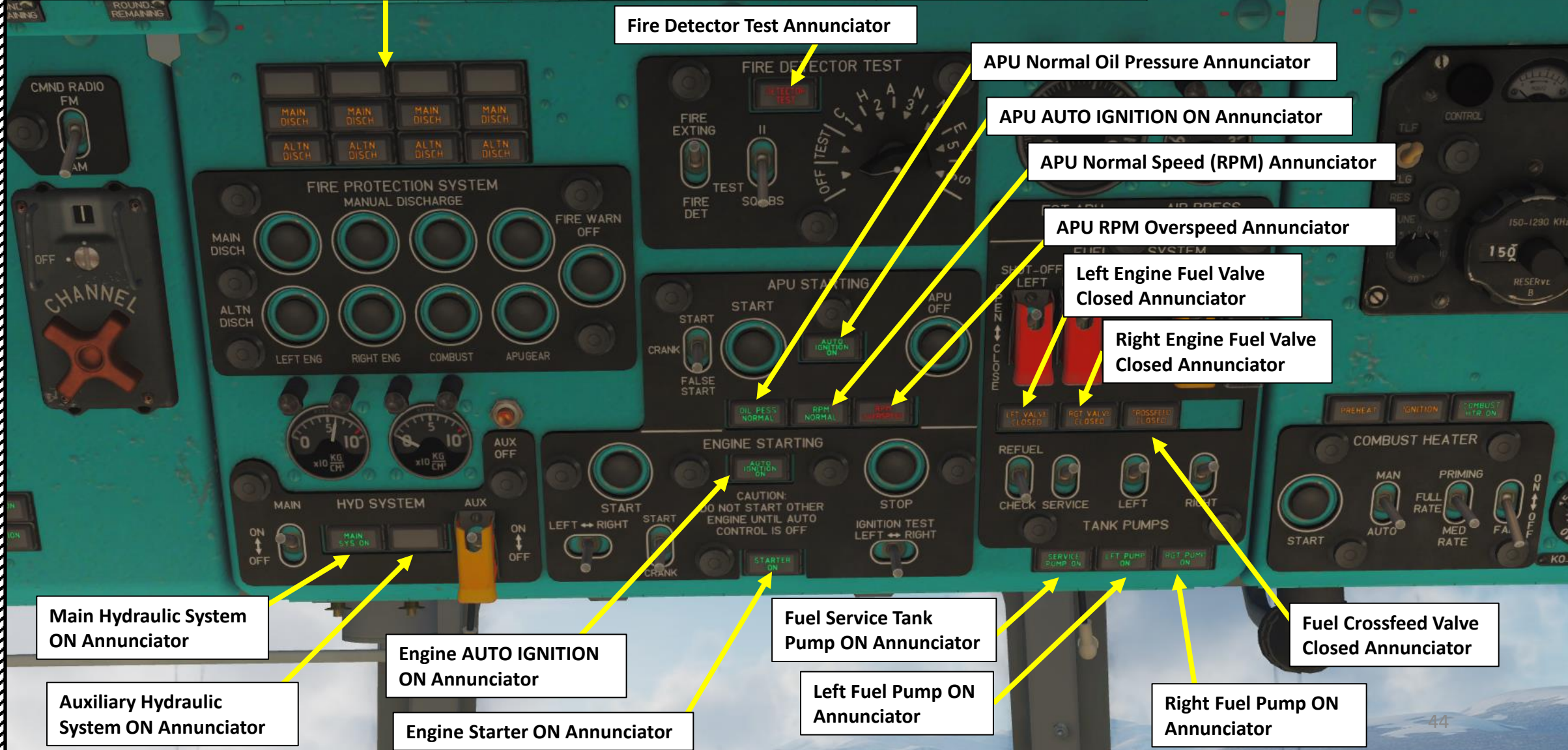

Fire Detector Test Annunciator

APU Normal Oil Pressure Annunciator

APU AUTO IGNITION ON Annunciator

APU Normal Speed (RPM) Annunciator

APU RPM Overspeed Annunciator

Left Engine Fuel Valve Closed Annunciator

Right Engine Fuel Valve Closed Annunciator

Main Hydraulic System ON Annunciator

Auxiliary Hydraulic System ON Annunciator

Engine AUTO IGNITION ON Annunciator

Engine Starter ON Annunciator

Fuel Service Tank Pump ON Annunciator

Left Fuel Pump ON Annunciator

Right Fuel Pump ON Annunciator

Fuel Crossfeed Valve Closed Annunciator



KO-50 Heater COMBUSTION HEATER ON Annunciator

KO-50 Heater IGNITION Annunciator

KO-50 Heater PREHEAT Annunciator

KO-50 Heater Start Button

**KO-50 Heater Mode Selector**  
UP: MANUAL  
MIDDLE: OFF  
DOWN: AUTOMATIC

**KO-50 Heater Regime Selector**  
UP: Priming  
MIDDLE: Full Rate  
DOWN: Medium Rate

**KO-50 Heater Master Temperature Control Knob**

**KO-50 Heater Fan Switch**

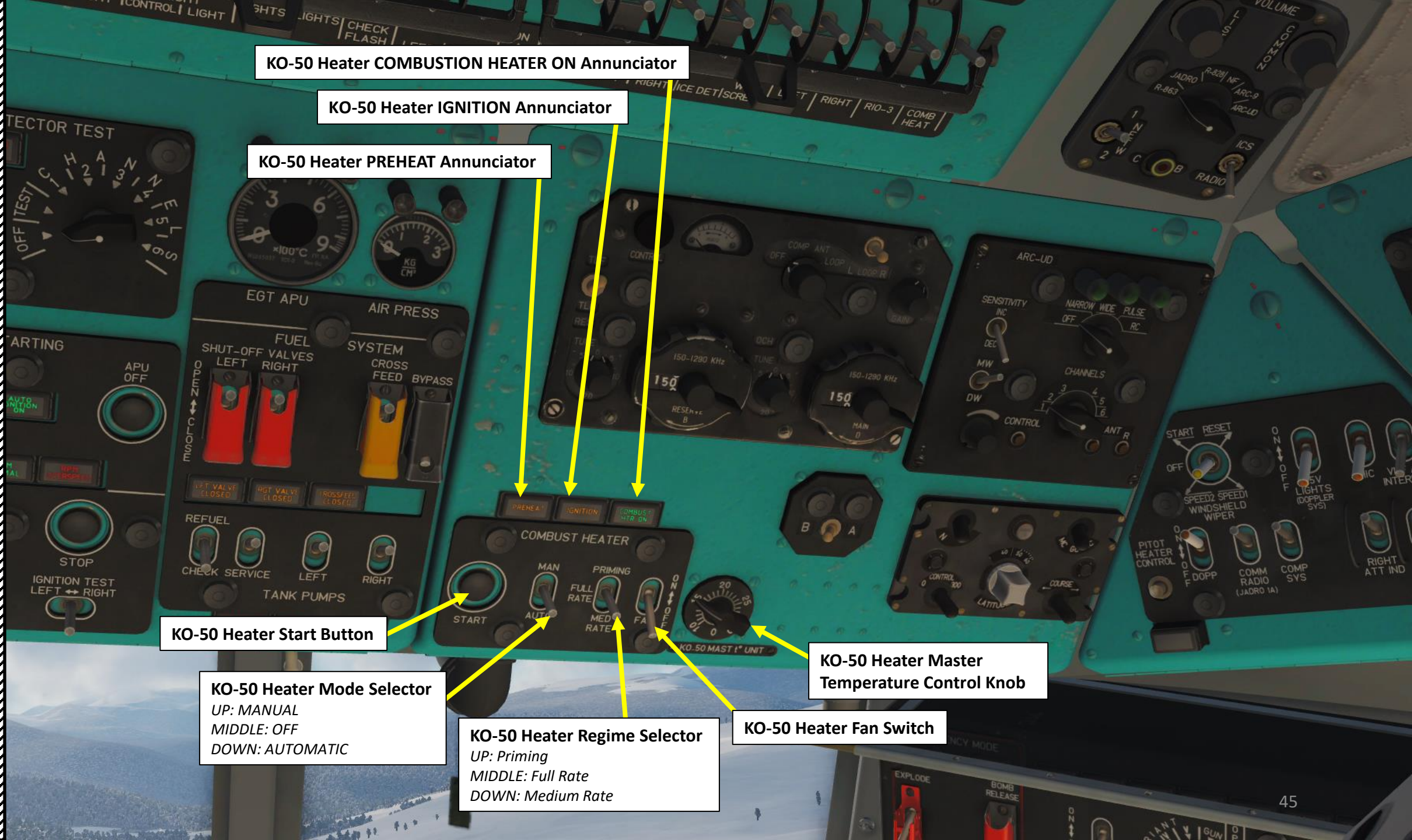



ARK-UD ADF Control Panel

ARK-9 ADF Control Panel

ARK-9 Frequency Dial  
Main / Backup

GMK-1A Gyrocompass Control Panel

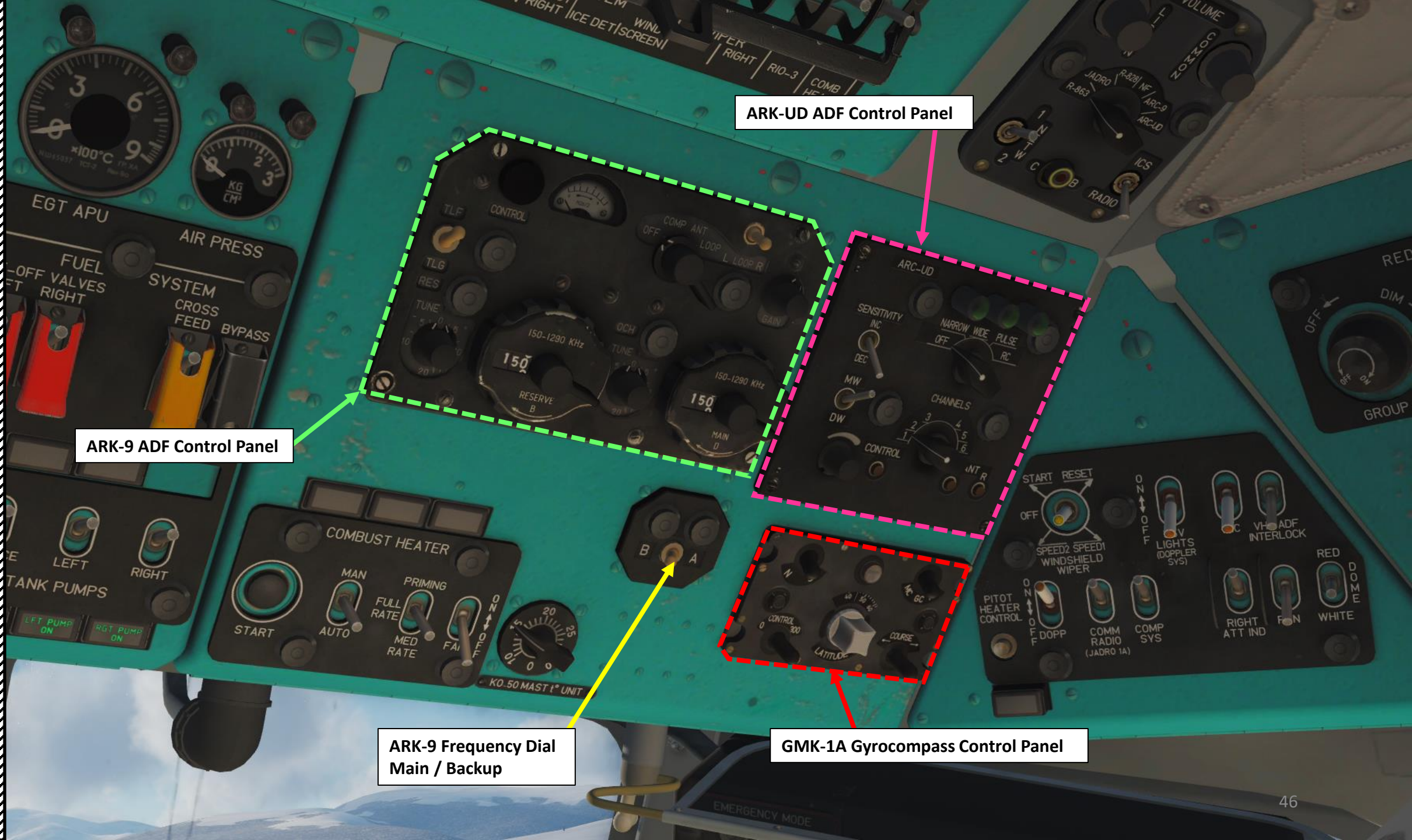



Radio Master Volume

Radio Monitor Volume

**Radio Selector**  
"YKP" (UHF) – R-863 UHF/VHF radio set  
"CP" (HF) – YaDRO-1A radio set  
"KP" (VHF) – R-828 LVHF radio set  
"ДР" (SW) – not utilized  
"PK 1" (ADF) – ARK-9 ADF set  
"PK 2" (SAR) – ARK-UD VHF homing set

CЕТЬ 1-2  
NET 1-2

Emergency Transmission Switch

**ICS/Radio Selector**  
СПУ: ICS InterComm Switch  
РАД: RADIO

**Doppler System & Yadro-1A radio control panel lighting switch**

Right Side Red Interior Lights Brightness Controls

Windshield Wiper Switch

Microphone Power Switch

Doppler System Power Switch

VHF-ADF Interlock Switch

Right Pitot Tube Heating Test Switch

**Right Ceiling Lights**  
UP = Red  
Middle = OFF  
DOWN = White

KO-50 Heater OK Annunciator

Fan Power Switch

Yadro-1A HF Radio Power Switch

Right Attitude Indicator Power Switch

Gyrocompass Power Switch



**Bomb Emergency Mode ARMED Annunciator**

**Bomb CCT (Electrical Circuit) ON Annunciator**

**BOMB RACK 1 through 6 LOADED Annunciators**

**ESBR Heating Switch**

**Bomb Jettison "Explode" Switch**  
UP: Bombs ARMED  
DOWN: OFF

**Lamp Test Button**

**Payload Profile Table**

**FAT: Free Air Temperature (deg C x 10)**

**Bombs Main Power Switch**

**Bomb Jettison Arming Switch**  
UP = ARMED  
DOWN = NOT ARMED

**Payload Profile Selector**  
I: All rockets  
II: All bombs  
III: 4 bombs + 2 rockets  
IV: 2 heavy bombs + 2 rocket launchers  
V: 2 heavy bombs + 2 standard bombs

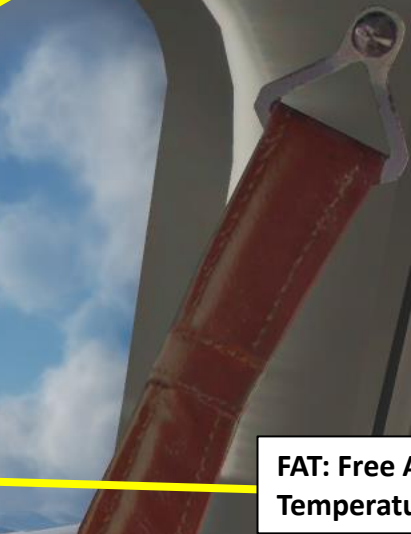
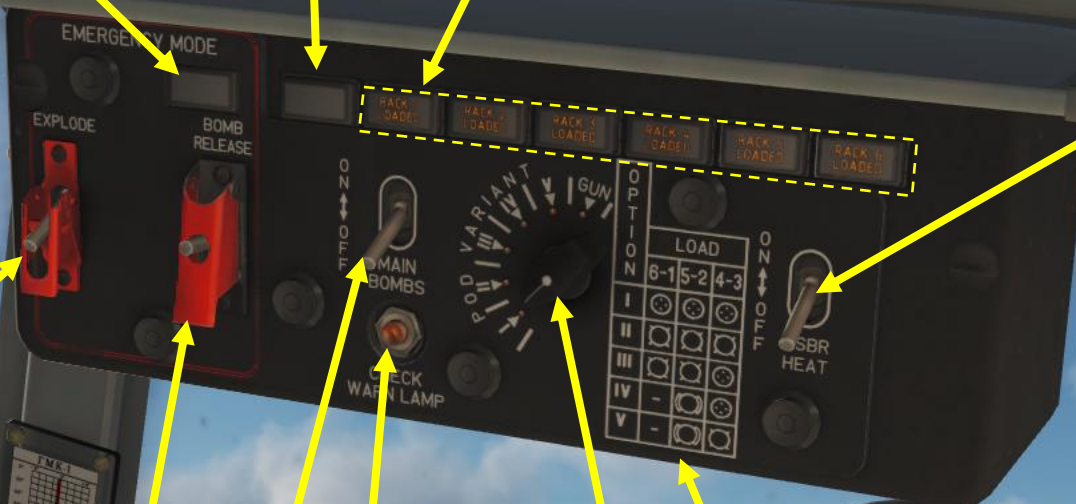



**PKT (Nose-Mounted Machinegun) Control Selector Switch**  
UP: Flight Engineer (SIDETECHNIQUE)  
DOWN: Pilot

**Barometric Altimeter**  
Short needle: 1000 m  
Long needle: 100 m

**HSI: Horizontal Situation Indicator**

**NS430 Navigation System**

**Mirror**

**Main Rotor Tachometer  
(% max RPM)**

**Airspeed Indicator  
(x10 km/h)**

**Attitude Indicator**

**Vertical Velocity Indicator (m/s)**







Fuel Quantity Indicator  
(x100 L)

Low Fuel (270 L)  
Annunciator Light

Clock

Fuel Content Selector  
"Вык" (OFF)  
"СУММА" (TOTAL)  
"Дл" (LEFT MAIN)  
"Дпр" (RIGHT MAIN)  
"РАСХ" (SERVICE CELL)  
"Пл" (LEFT AUXILIARY)



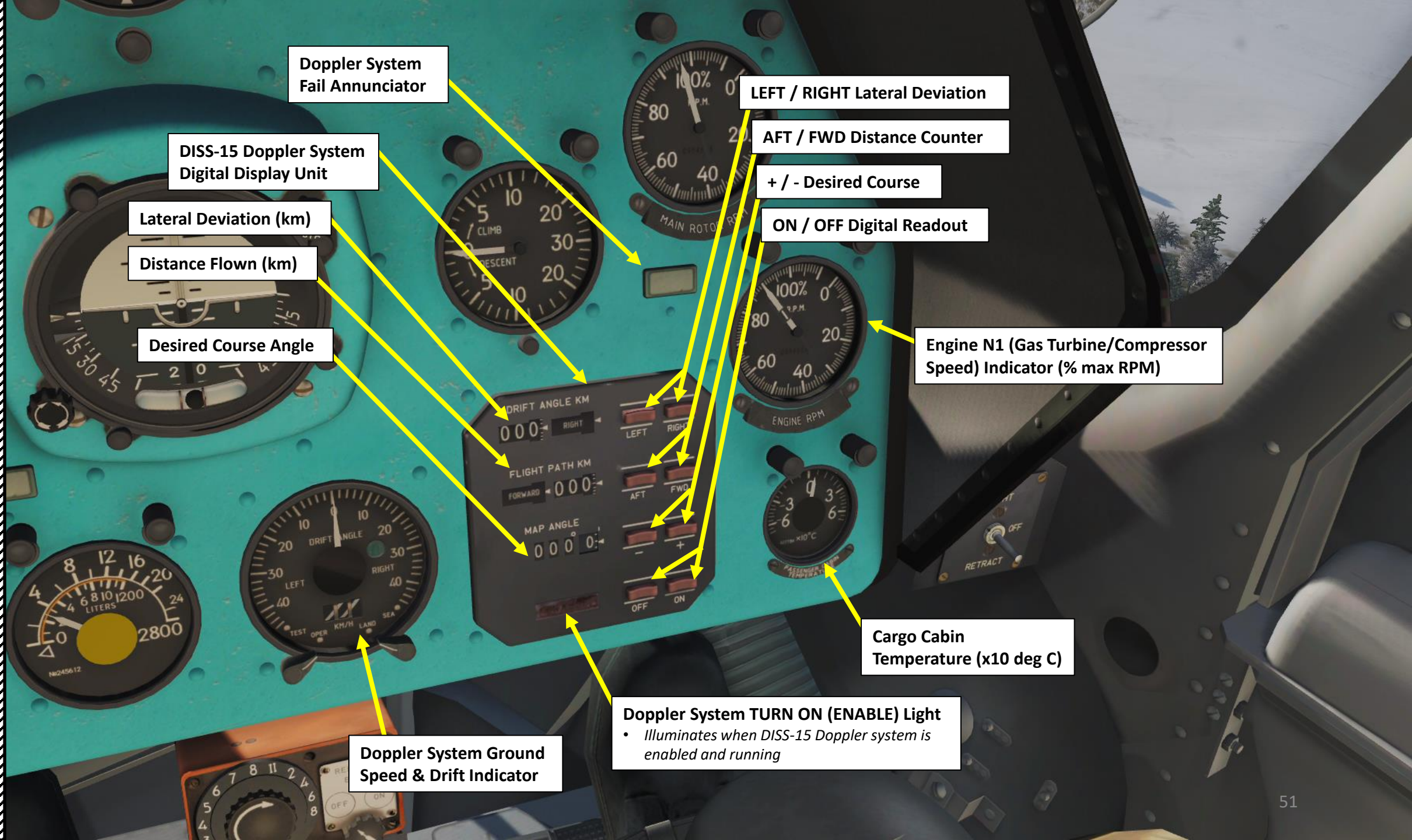

**Doppler System Fail Annunciator**

**DISS-15 Doppler System Digital Display Unit**

**Lateral Deviation (km)**

**Distance Flown (km)**

**Desired Course Angle**

**LEFT / RIGHT Lateral Deviation**

**AFT / FWD Distance Counter**

**+ / - Desired Course**

**ON / OFF Digital Readout**

**Engine N1 (Gas Turbine/Compressor Speed) Indicator (% max RPM)**

**Cargo Cabin Temperature (x10 deg C)**

**Doppler System TURN ON (ENABLE) Light**  
• Illuminates when DISS-15 Doppler system is enabled and running

**Doppler System Ground Speed & Drift Indicator**





**Bomb/Store Release Setting**  
I: Single  
II: Pairs  
Arabic numerals: Release Number in release sequence

**Electrical Release Control System (ESBR) Power**  
Left: OFF / Right: ON

**Right Landing Light Switch**  
UP: LIGHT ON  
MIDDLE: OFF  
DOWN: RETRACT



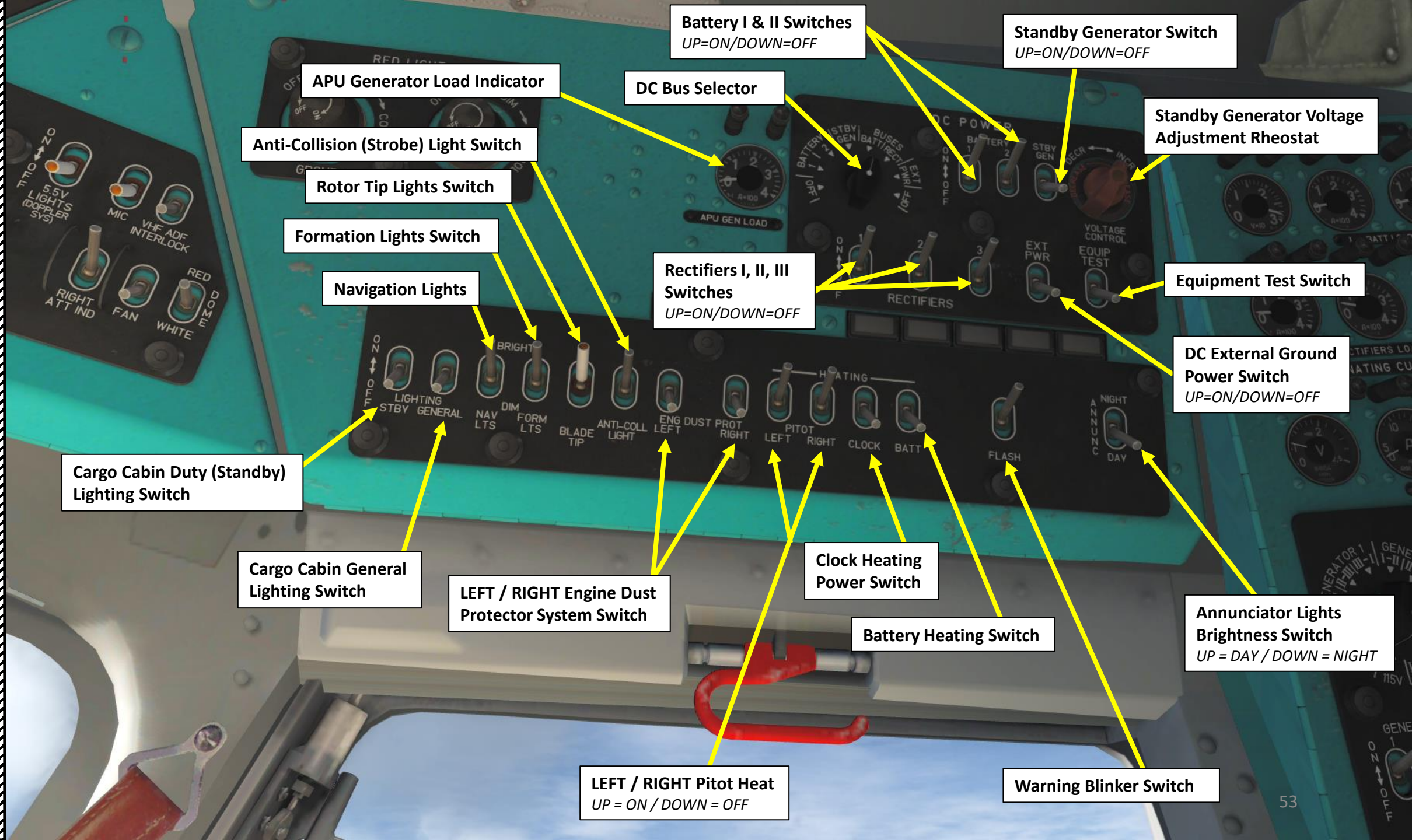

APU Generator Load Indicator

Battery I & II Switches  
UP=ON/DOWN=OFF

Standby Generator Switch  
UP=ON/DOWN=OFF

Anti-Collision (Strobe) Light Switch

DC Bus Selector

Standby Generator Voltage Adjustment Rheostat

Rotor Tip Lights Switch

Formation Lights Switch

Rectifiers I, II, III Switches  
UP=ON/DOWN=OFF

Equipment Test Switch

Navigation Lights

DC External Ground Power Switch  
UP=ON/DOWN=OFF

Cargo Cabin Duty (Standby) Lighting Switch

Cargo Cabin General Lighting Switch

LEFT / RIGHT Engine Dust Protector System Switch

Clock Heating Power Switch

Battery Heating Switch

Annunciator Lights Brightness Switch  
UP = DAY / DOWN = NIGHT

LEFT / RIGHT Pitot Heat  
UP = ON / DOWN = OFF

Warning Blinker Switch



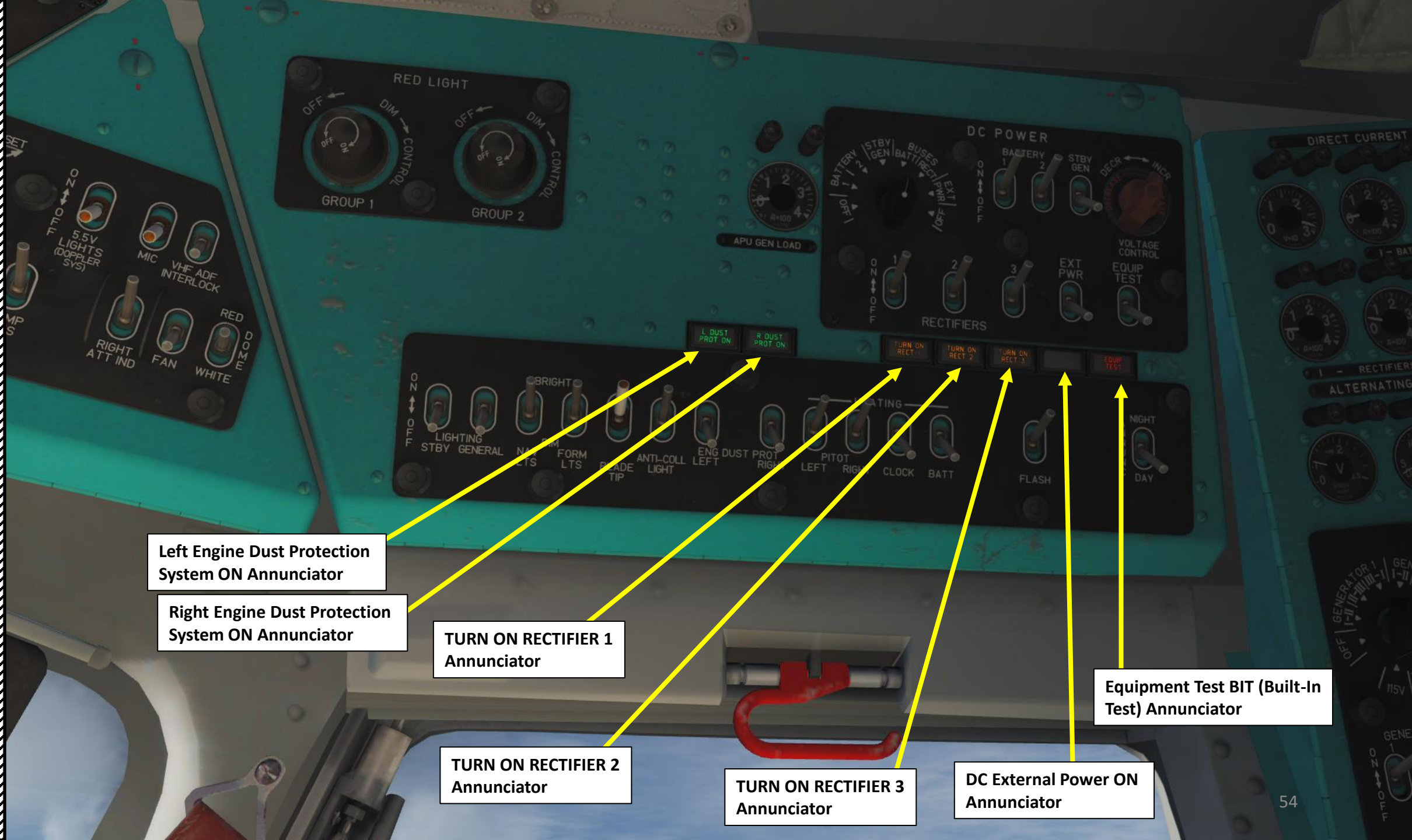

Left Engine Dust Protection System ON Annunciator

Right Engine Dust Protection System ON Annunciator

TURN ON RECTIFIER 1 Annunciator

TURN ON RECTIFIER 2 Annunciator

TURN ON RECTIFIER 3 Annunciator

DC External Power ON Annunciator

Equipment Test BIT (Built-In Test) Annunciator



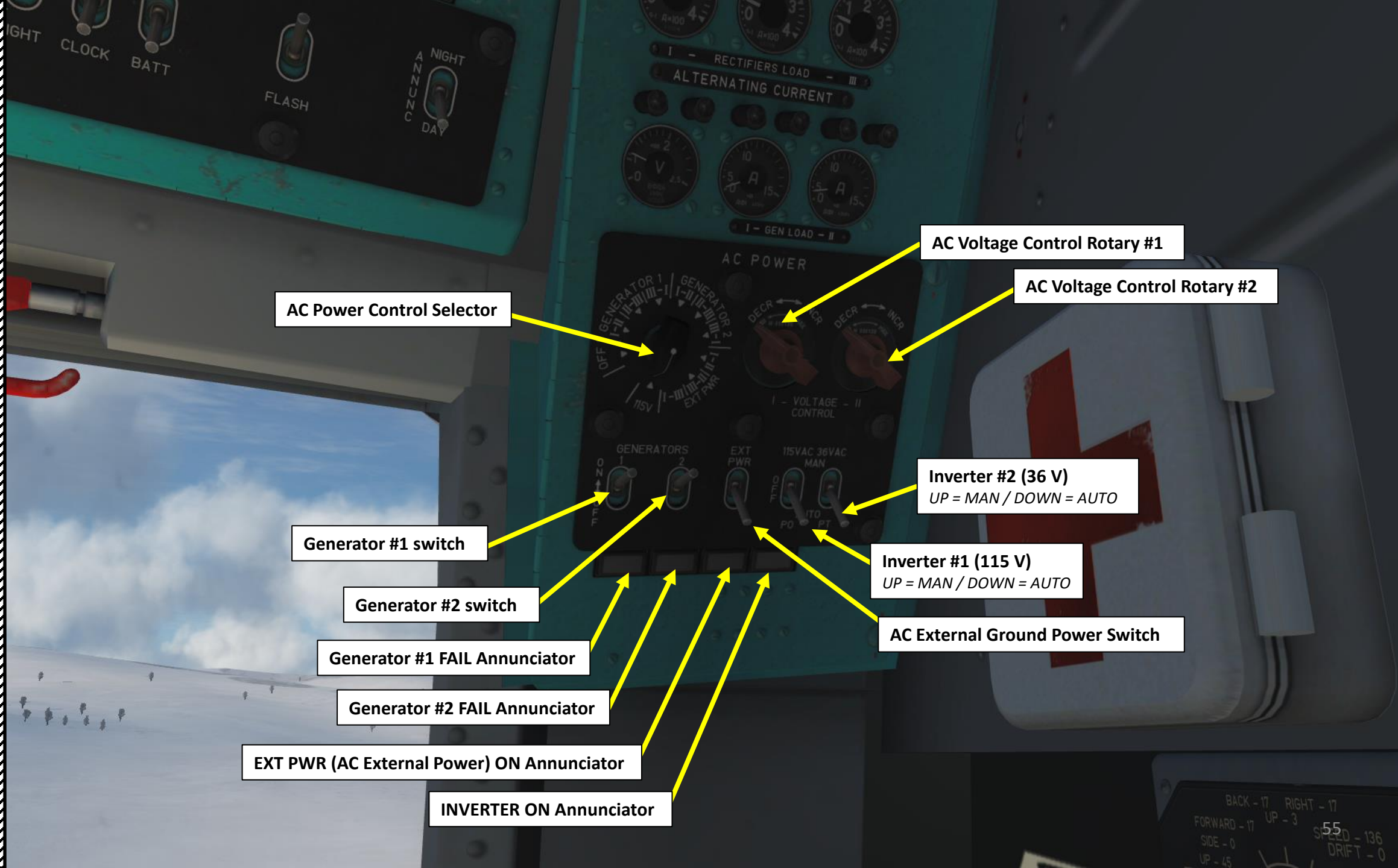

AC Power Control Selector

AC Voltage Control Rotary #1

AC Voltage Control Rotary #2

Generator #1 switch

Generator #2 switch

Generator #1 FAIL Annunciator

Generator #2 FAIL Annunciator

EXT PWR (AC External Power) ON Annunciator

INVERTER ON Annunciator

Inverter #2 (36 V)  
UP = MAN / DOWN = AUTO

Inverter #1 (115 V)  
UP = MAN / DOWN = AUTO

AC External Ground Power Switch



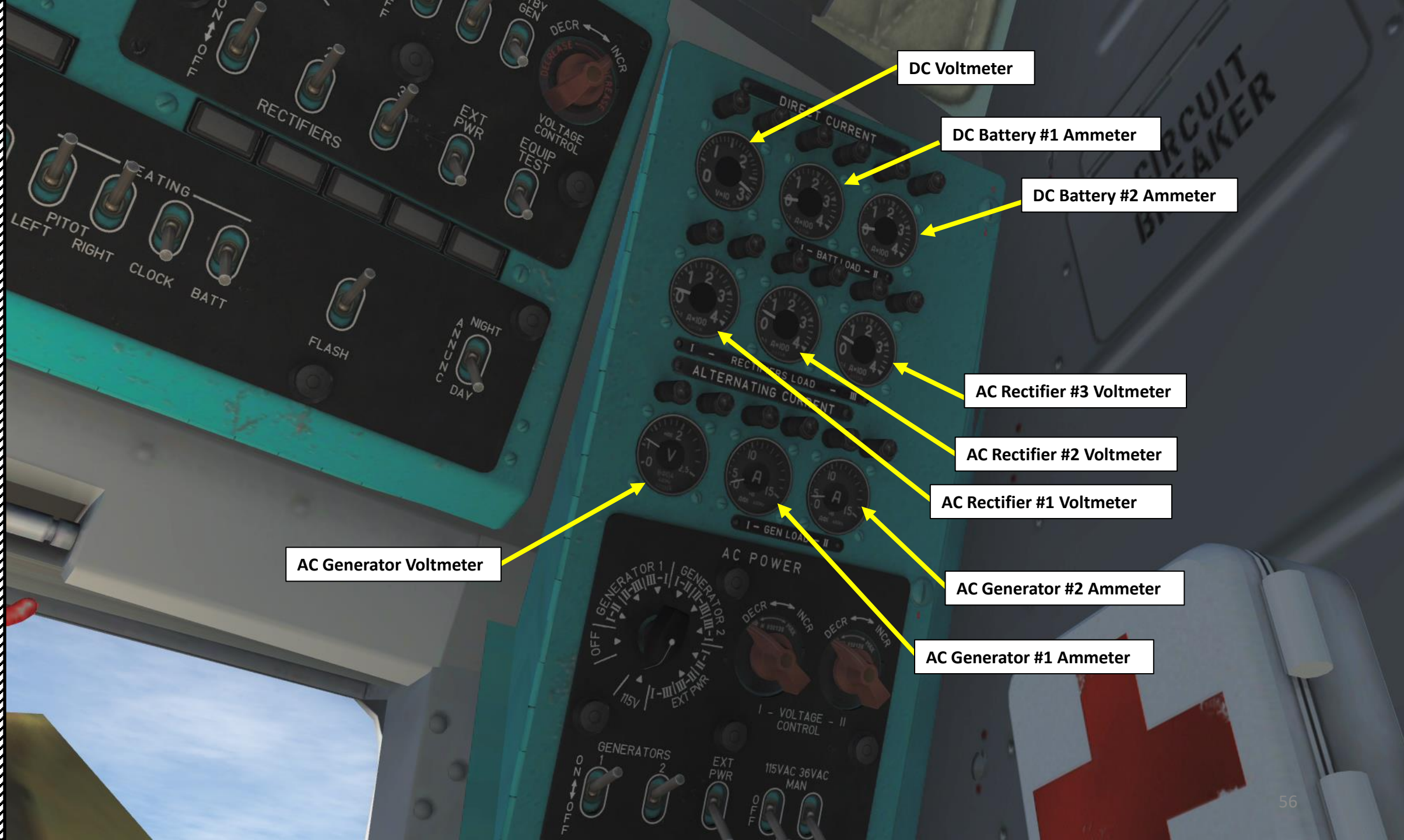

DC Voltmeter

DC Battery #1 Ammeter

DC Battery #2 Ammeter

AC Rectifier #3 Voltmeter

AC Rectifier #2 Voltmeter

AC Rectifier #1 Voltmeter

AC Generator #2 Ammeter

AC Generator #1 Ammeter

AC Generator Voltmeter



**PART 3 – COCKPIT & GAUGES**

MI-8MTV2  
HIP



**Doppler Control Panel  
Mode selector**  
*Position 1-4: Test  
РАБОТА: OPERATE*



**Magnetron Failure Light**

**Doppler Computer  
Failure Light**



**5.5 V Backlight  
Brightness Control**



R-828 Radio Channel Setter

R-828 Power  
FWD = ON  
AFT = OFF

R-828 Radio Mode  
FWD: NAV HOMING  
AFT: COMM VOICE

YaDRO-1A Squelch Knob

YaDRO-1A Test Switch

YaDRO-1A Volume Control

R-828 Radio Volume

R-828 Radio Squelch

R-828 Radio ACG  
Automatic Gain Control

YaDRO-1A Mode Selector  
"ВЫКЛ" (OFF)  
"OM" (SSB, Single Sideband)  
"AM" (AM)

YaDRO-1A  
Frequency Setter



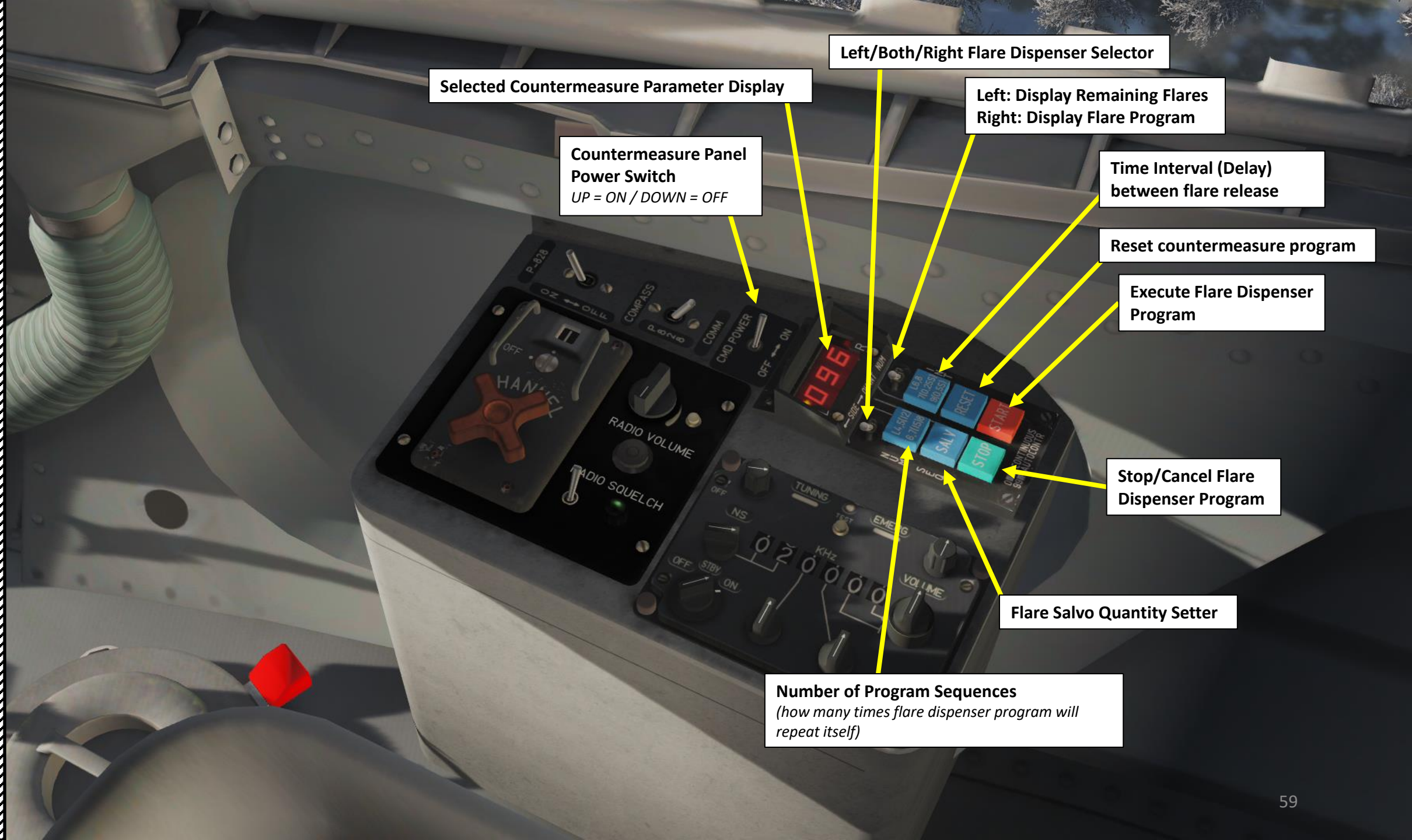

Selected Countermeasure Parameter Display

Countermeasure Panel  
Power Switch  
UP = ON / DOWN = OFF

Left/Both/Right Flare Dispenser Selector

Left: Display Remaining Flares  
Right: Display Flare Program

Time Interval (Delay)  
between flare release

Reset countermeasure program

Execute Flare Dispenser  
Program

Stop/Cancel Flare  
Dispenser Program

Flare Salvo Quantity Setter

Number of Program Sequences  
*(how many times flare dispenser program will repeat itself)*



# PART 3 - COCKPIT & GAUGES





**PART 3 - COCKPIT & GAUGES**

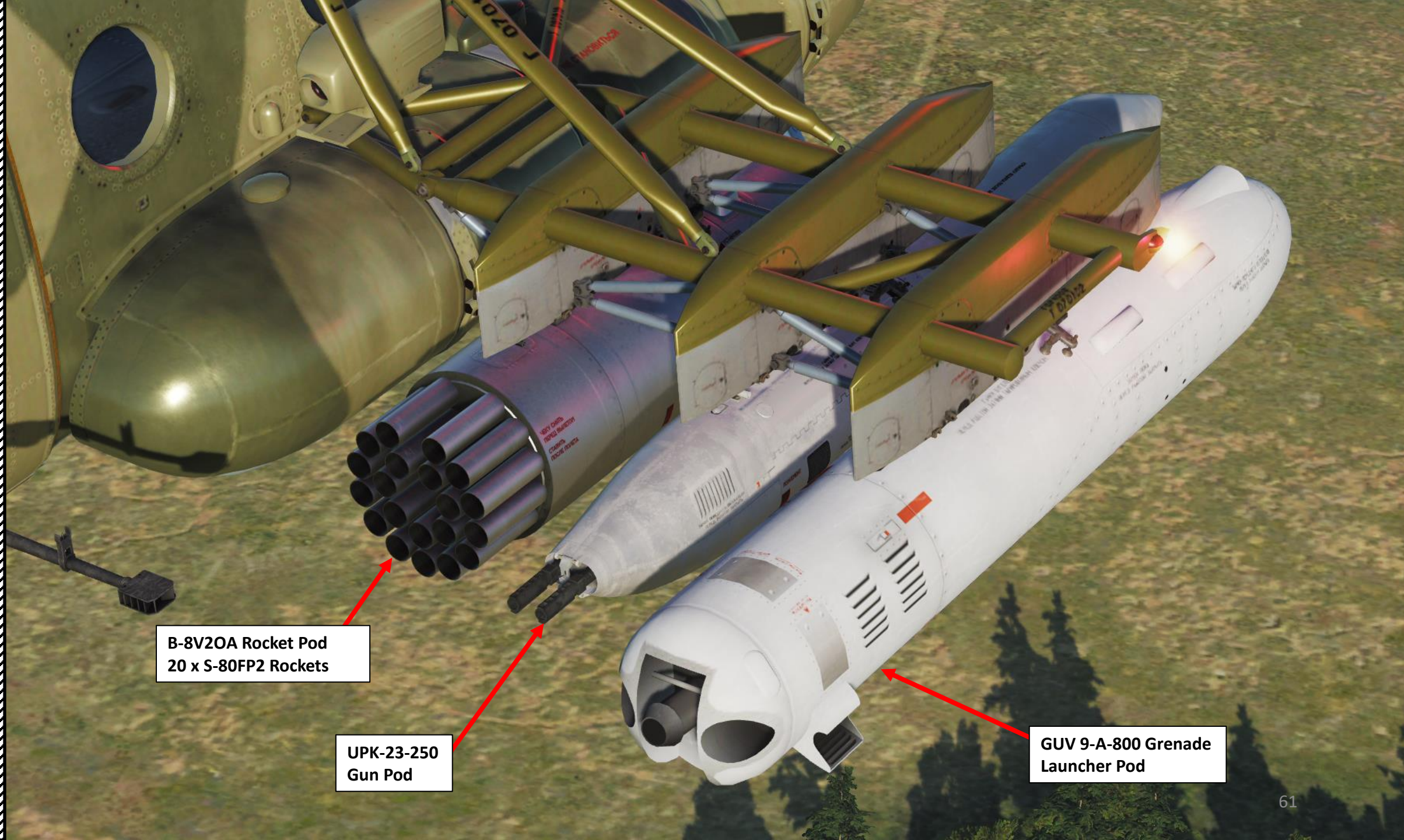

B-8V20A Rocket Pod  
20 x S-80FP2 Rockets

UPK-23-250  
Gun Pod

GUV 9-A-800 Grenade  
Launcher Pod



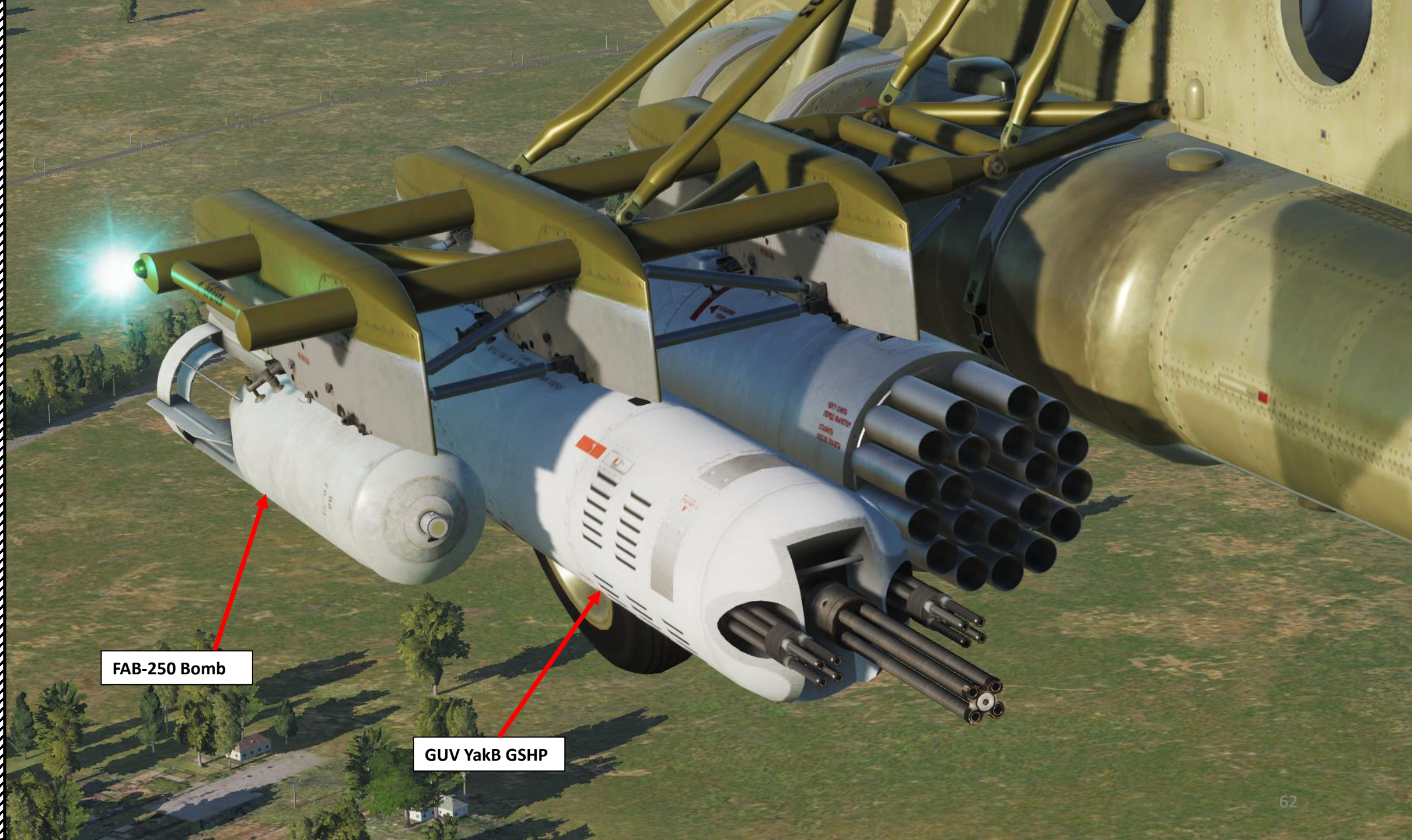

FAB-250 Bomb

GU-19 YakB GSHP



MI-8MTV2

HIP

# PART 3 - COCKPIT & GAUGES

Pitot Tube



Armor Plates



Pitot Tube





Right Landing Light

Taxi Light

Left Landing Light



Fig. 7.36. Search/taxi light beam controls

- |   |  |
|---|--|
| 1. Light (beam) forward (up) $[LShift + 8]$ (left light) / $[RShift + 8]$ (right light) | 3. Light (beam) backward (down) $[LShift + 7]$ / $[RShift + 7]$      |
| 2. Light (beam) rotation to the right $[LShift + 0]$ / $[RShift + 0]$                   | 4. Light (beam) rotation to the left $[LShift + 9]$ / $[RShift + 9]$ |

**Note:**

Landing Lights are also used as Search Lights. They are controllable individually with the Light Beam Control hat switch on the collective (pilot & copilot).



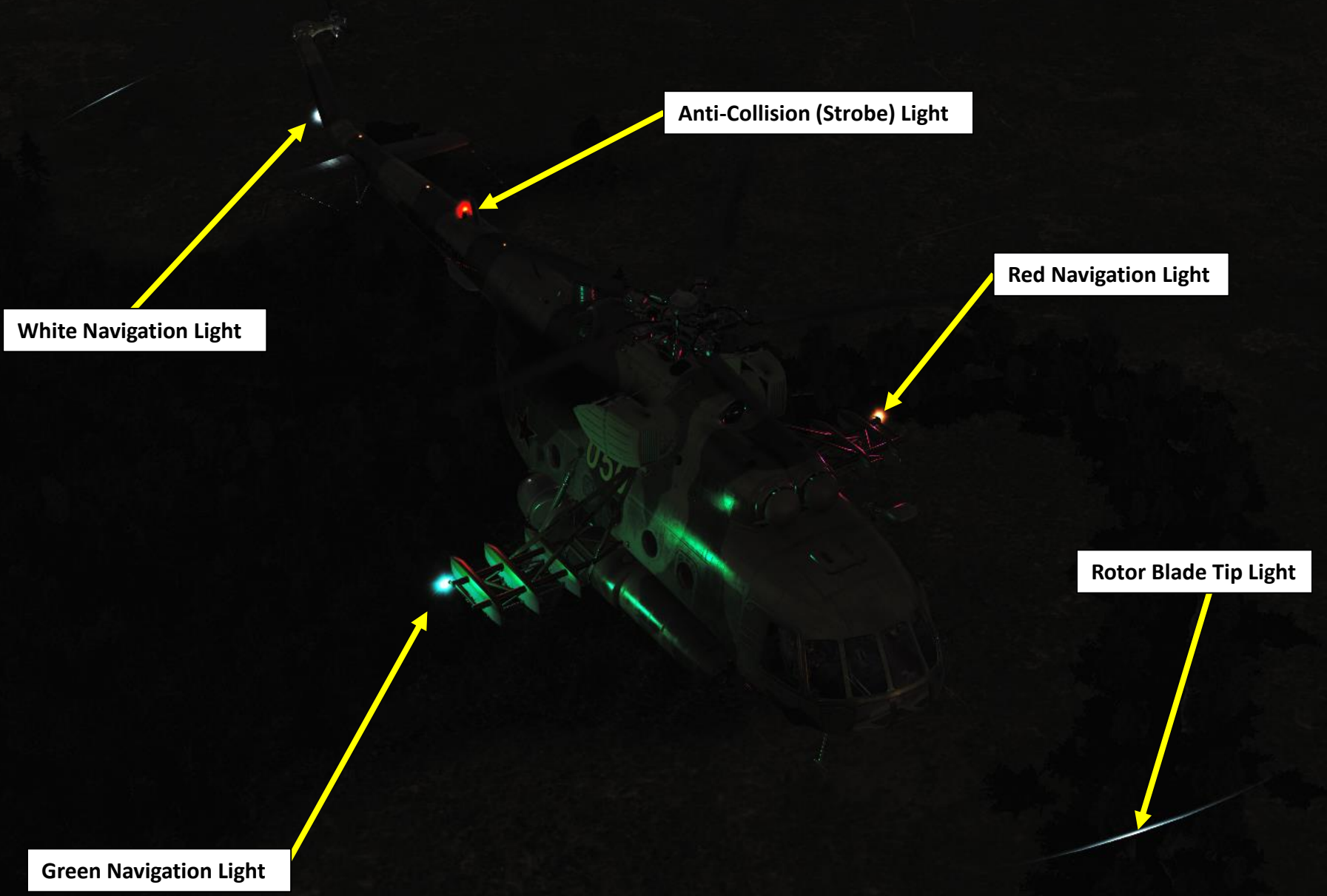





Formation Light

Formation Light

Formation Light



Oil Cooler Fan

PZU  
Engine Inlet & Particle Separator System (PSS),  
also known as Dust Protection Device (DPD)

Engine Exhaust Infrared  
Signature Suppressor







DISS-15 Doppler Radar High Frequency Unit

Tail Skid





PPI-26 Flare Cartridge Mounts



## PRE-FLIGHT

The Pre-Flight phase is very important. Your payload will depend on the air temperature (FAT), the humidity and the pressure-altitude. The Pre-Flight planning is a tedious task and a good example is available in my UH-1H Huey guide. I recommend you check this out.

In the meantime, I will simply introduce you the general idea of the parameters you should take into account when flying the Mi-8.



FAT: Free Air Temperature  
(deg C x 10)

The nose wheel running takeoff maximum takeoff weight chart can be used to determine the max takeoff weight for a nose wheel running takeoff.

Execute a test hover to verify correct maximum weight calculation prior to performing a nose wheel running takeoff. The takeoff can be performed if the helicopter is able to lift off the ground during the test hover. In all cases, the max takeoff weight should never exceed 13000 kg (Mi-8 maximum takeoff gross weight).

Maximum Takeoff Weight for a Nose Wheel Running Takeoff

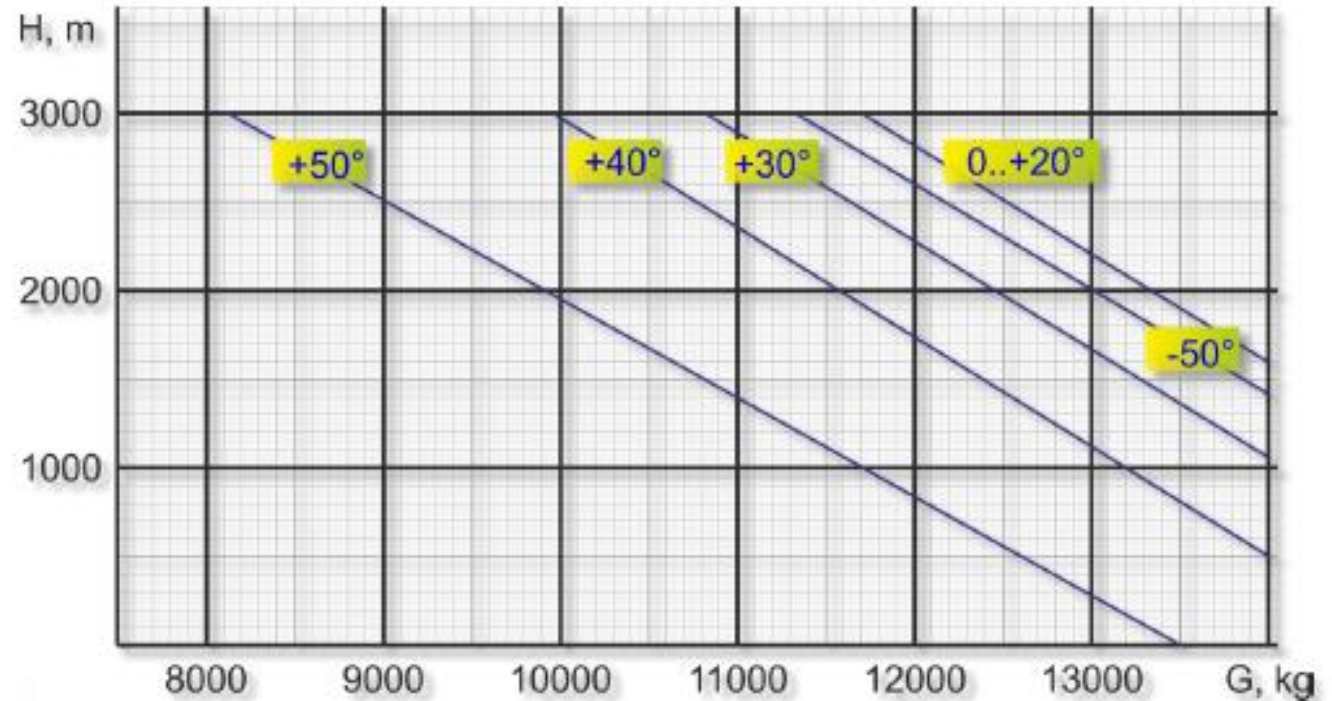



## CALCULATING MAXIMUM TAKEOFF WEIGHT

Maximum takeoff weight for **out of ground effect** vertical takeoff (landing) (OGE max hover weight) is displayed by **Chart B**. Maximum takeoff weight for **in ground effect** vertical takeoff (landing) (IGE maximum hover weight) is displayed by **Chart C**.

The max hover weight charts display max takeoff weight in relation to the pressure altitude of the landing field and free air temperature (FAT), assuming calm winds, 93 % main rotor RPM, disengaged PZU air inlet particle separator system, and disengaged anti-icing systems.

**CHART B: OGE Maximum Hover Weight Chart (Hover Altitude 20 m)**  
PZU & Anti-Icing Disabled

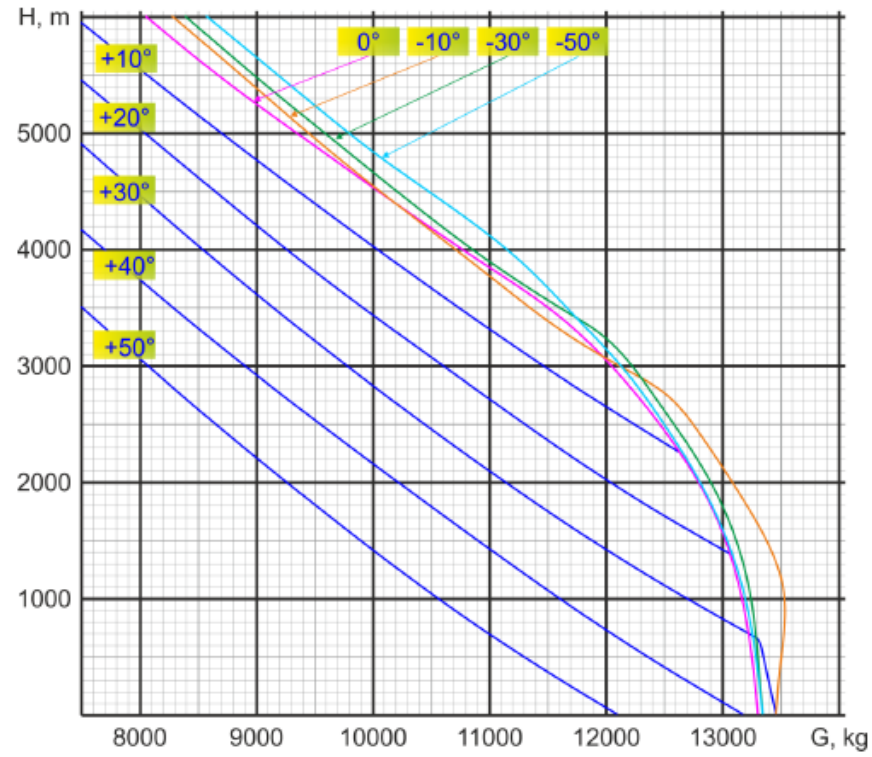

With PZU system turned on, reduce max weight indicated in chart by 200 kg. With engine and rotor anti-ice systems turned ON, reduce max weight indicated in chart by 1000 kg.

**CHART C: IGE Maximum Hover Weight Chart (Hover Altitude 3 m)**  
PZU & Anti-Icing Disabled

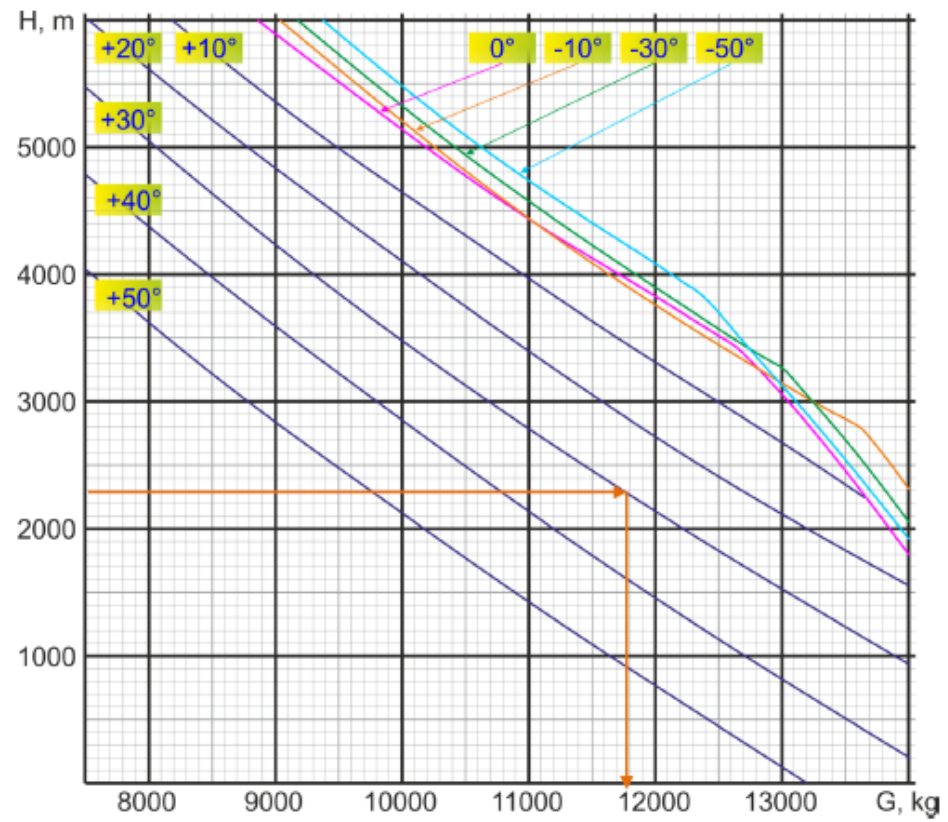

Any headwind increases max takeoff weight: + 200 kg at 5 m/s; +1200 kg at 10 m/s.

Crosswind up to 5 m/s reduces performance by affecting the tail rotor and increasing engine power requirements. Reduce max takeoff weight by 200 kg in the presence of a crosswind of up to 5 m/sec. At greater crosswind speeds, translational lift effects become more dominant.

Chart C includes a solution (orange arrows) to the following example problem: determine the maximum hover weight for vertical takeoff in ground effect from an airfield located at an altitude of 2,300 m and +30°C FAT.

**SOLUTION:**  
Using the IGE maximum hover weight Chart C, enter the graph from the left at the point of the desired pressure altitude of 2,300 m. Draw a line horizontally to intersect the desired temperature of +30°C. From the intersection point, draw a vertical line down to find the maximum hover weight value, in this case 11,780 kg. To determine the maximum takeoff weight for a vertical takeoff out of ground effect, perform the same process using the OGE maximum hover weight Chart B.



**PERFORMANCE DATA TABLE**

Normal takeoff weight	11100 kg
Maximum takeoff weight	13000 kg
Cargo capacity:	
normal	2000 kg
maximum (with full main fuel tanks)	4000 kg
troops	21 – 24
medical stretchers	12
Maximum level flight speed at altitudes 0 – 1000 m:	
normal takeoff weight	250 kph
maximum takeoff weight	230 kph
Cruising speed at altitudes 0 – 1000 m:	
normal takeoff weight	220–240 kph
maximum takeoff weight	205–215 kph
Hover ceiling with normal takeoff weight OGE (standard atmosphere)	3960 m
Service ceiling:	
normal takeoff weight	5500 m
maximum takeoff weight	3900 m
Time required to reach altitude at nominal engine power and ideal climbing speed (120 kph), anti-icing system disabled:	
normal takeoff weight	
1000 m	1.8 <sup>+0.5</sup> min
3000 m	6 <sup>+1</sup> min
4000 m	9.5 <sup>+2</sup> min
maximum takeoff weight	
1000 m	2.4 <sup>+0.5</sup> min
3000 m	10.9 <sup>+1</sup> min
Service range at an altitude of 500 m and cruising speed with full main fuel tanks before 5% fuel reserve reached:	
cargo load 2117 kg	495 km
cargo load 4000 kg	465 km
one full internal auxiliary fuel tank	725 km
two full internal auxiliary fuel tanks (ferry range)	950 km



MI-8MTV2  
HIP

**PART 5 - START-UP PROCEDURE**





## PRE-START

*NOTE: Some steps from the real life checklist will be omitted to keep the procedure concise and practical. A link to the full checklist will be available at the end of the Start-Up section. We will assume that your helicopter is in pristine condition and that the ground crew did their job properly. Also, make sure you switch to appropriate position to reach the switches you need to press (pilot/co-pilot/engineer = 1/2/3)*

1. Engine control levers (ECL) – Check that levers are in the MIDDLE detent position
2. Throttle Twist Grip – FULL LEFT (Page Down binding)
3. Collective – FULLY DOWN
4. Rotor Brake Lever – OFF (FULLY DOWN)
5. Battery I and II switches– ON (UP)
6. DC selector knob – BATT BUS
7. STBY Gen – OFF (DOWN)
8. DC voltmeter – Check (Not below 24V)

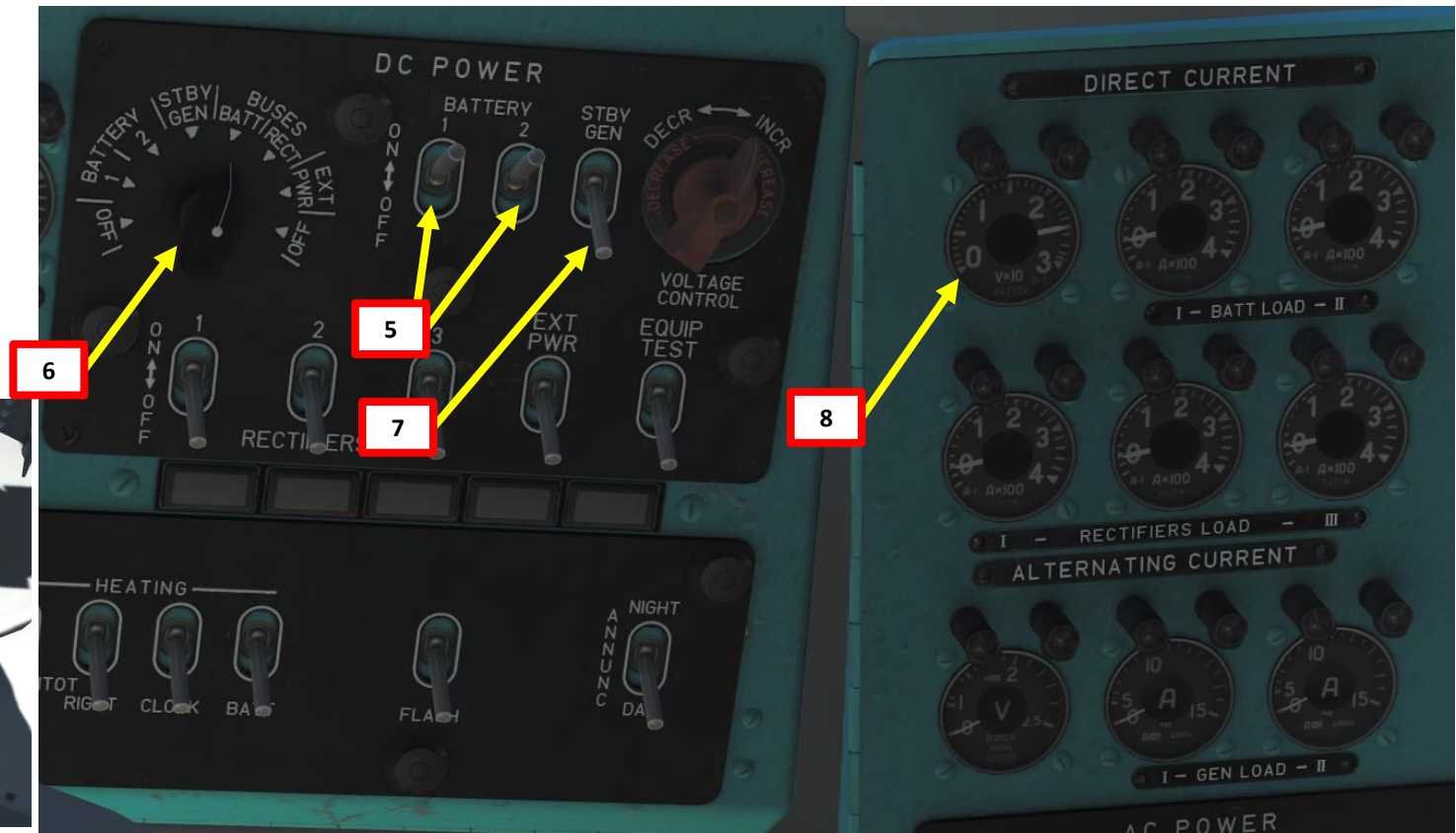
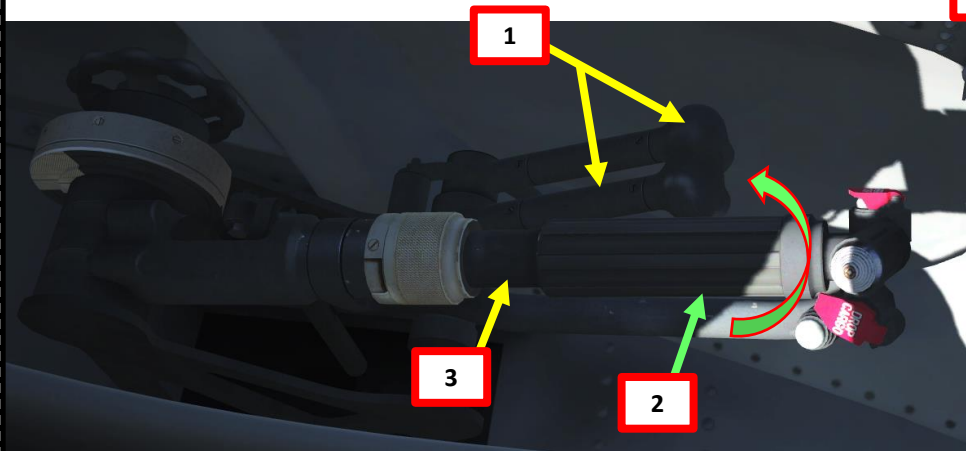
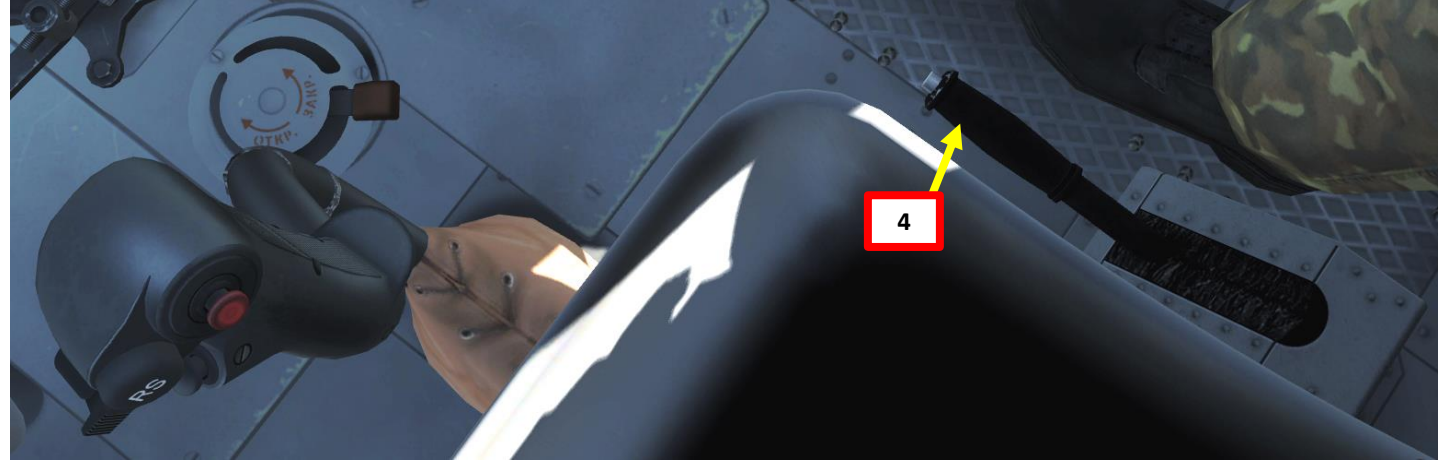



**PRE-START**

9. On the center console, set 36V Instrument Transformer – MAIN (UP)
10. 115V Inverter – MANUAL (UP)
11. Select Flight Engineer by pressing “3” and turn on all circuit breakers by clicking handles.
12. Turn off Anti-Ice system breakers if you are flying in a hot day (above 0 deg C).
13. Set Fire Circuit Check Selector – OFF
14. Arm the Fire Suppression System: set Fire Detector Test switch – FIRE EXTING (UP)

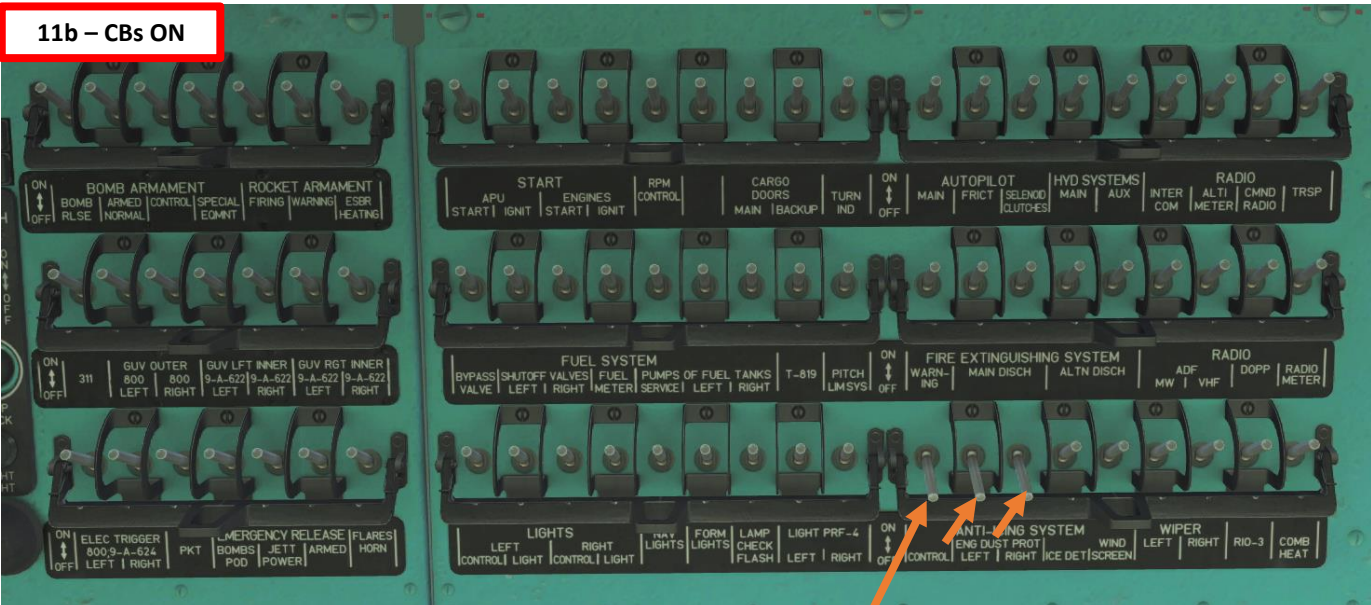
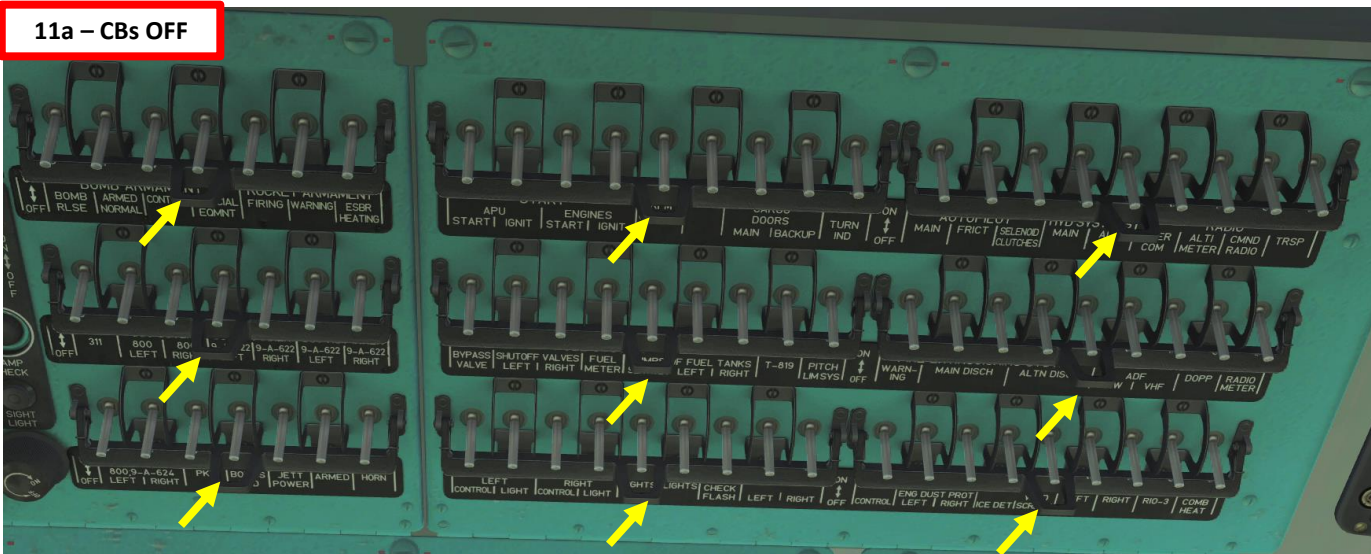
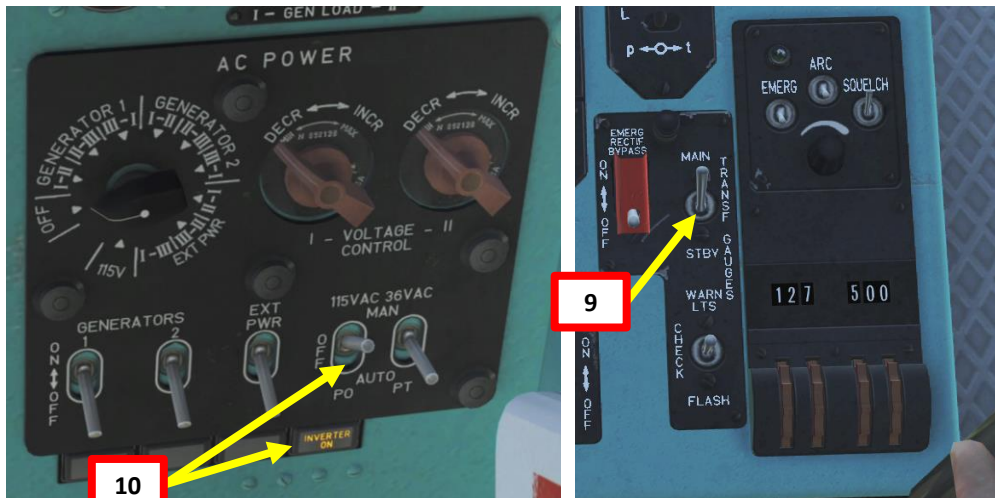



**PRE-START**

15. Set Left & Right Fuel Shutoff Valve Switches – OPEN (UP)
- (Note: flip red cover up)
16. Set Service Tank Fuel Pump Switch – ON (UP)
17. Set Left & Right Engine Fuel Pump Switches – ON (UP)
18. Set Hydraulic switch – MAIN (UP)
19. Set Fuel Crossfeed valve – ON (UP)
20. Set Fuel Bypass Switch – OFF (DOWN).
21. Set Fuel Content Selector to “Total” and check fuel quantity.
22. Set radio to AM, R-863 (УКР/UHF) and RADIO
23. Tune radio to desired frequency (tower)

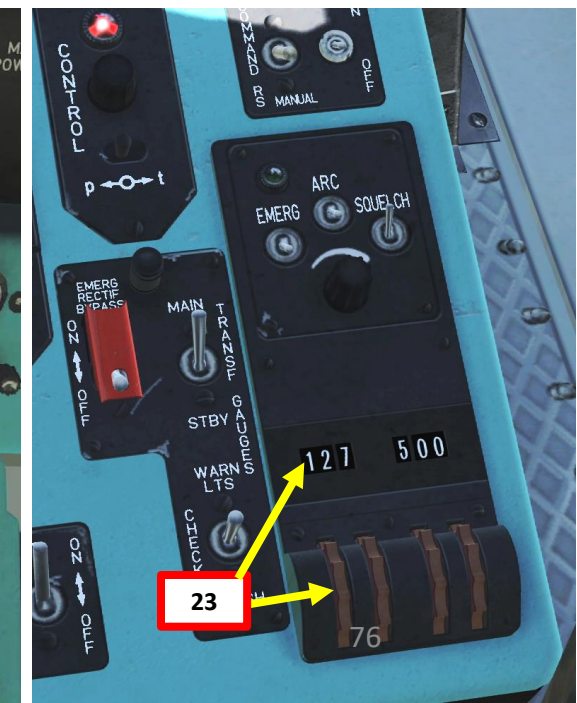
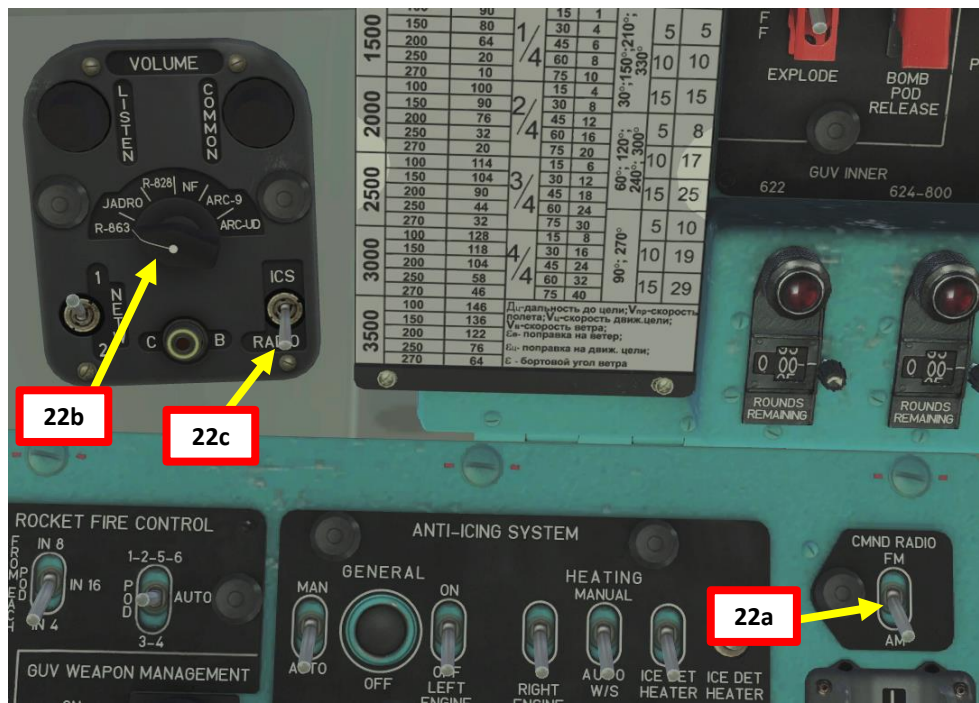
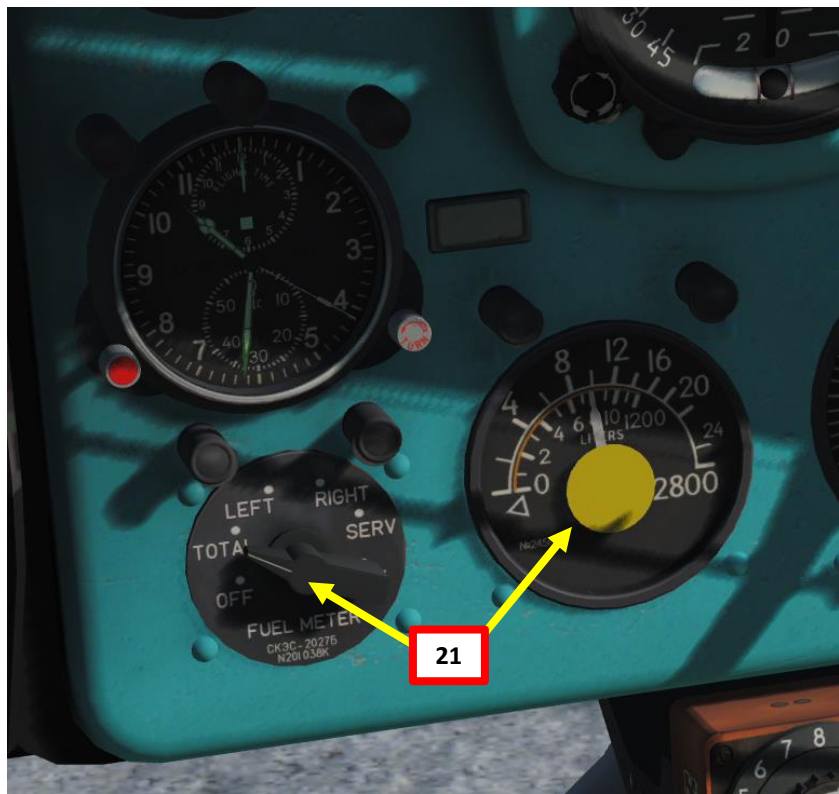
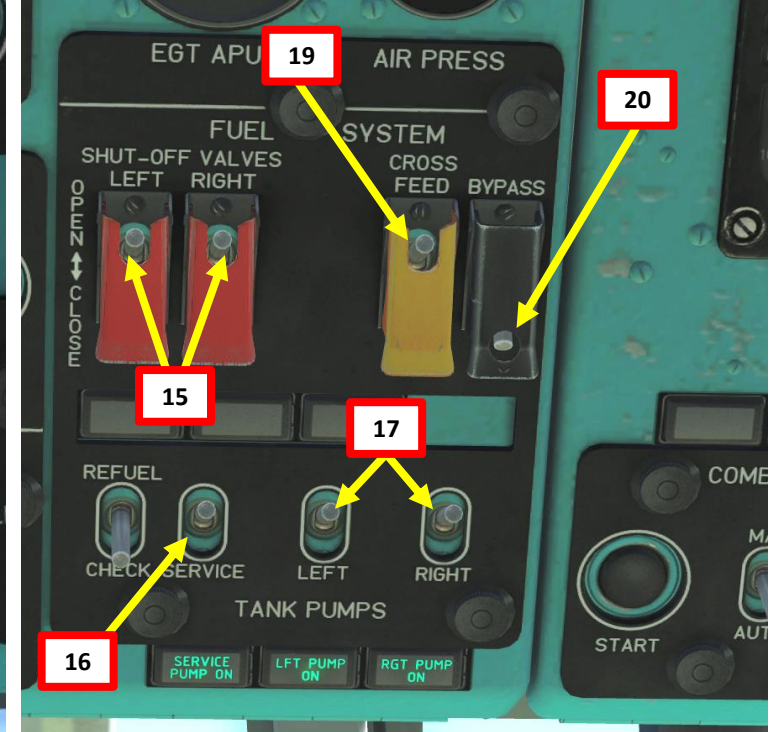



## START-UP (APU START)

1. APU (Auxiliary Power Unit) Mode Switch – START (UP).
2. Press APU START switch for 2 to 3 sec.
3. Confirm that AUTO IGNITION ON annunciator illuminates during APU start. This indicates a good APU start.
4. Make sure APU EGT (Exhaust Gas Temperature), Air Pressure and Oil Pressure (OIL PESS NORMAL annunciator) are rising within 9 seconds.
5. Wait until APU EGT (Exhaust Gas Temperature) stabilizes below 720 deg C, APU air pressure stabilizes between 1.2 and 2.0 kg/cm<sup>2</sup>, and APU RPM reaches IDLE Speed (RPM NORMAL annunciator). Process should take between 20 sec and 1 minute.
6. Now that the APU is started, the air pressure generated by it will be used to drive the engine pneumatic starter.
7. The APU must run for a minimum of 1 minute before attempting to start the main engines.



4  
APU Oil Pressure Normal





## START-UP (LEFT ENGINE START)

8. Select Left Engine (or downwind engine first) and select "START" (UP) starting mode.
9. Press "START" button for 2 to 3 seconds to initiate start sequence.
10. Confirm good engine start: engine oil pressure should increase, and the AUTO IGNITION ON and STARTER ON annunciators should be visible.
11. Once Engine N1 (Gas Turbine/Compressor Speed) increases, click on left/selected engine red fuel shutoff lever ("Engine Stop") to push it forward. Fuel flow will kick in and engine N1 will increase to IDLE speed.
12. Once Left Engine reaches a N1 RPM of 70-75 % (IDLE speed), wait 1 minute for APU to cool down (optional).

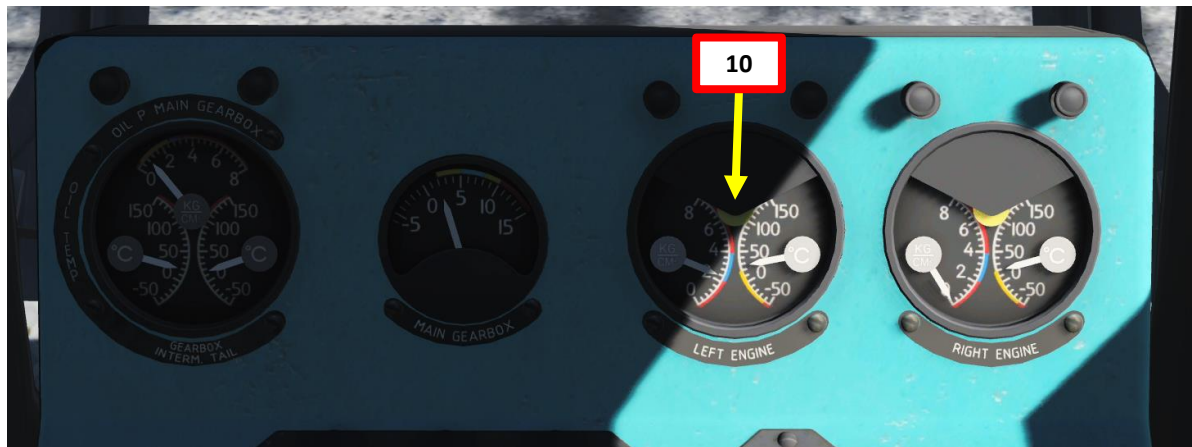
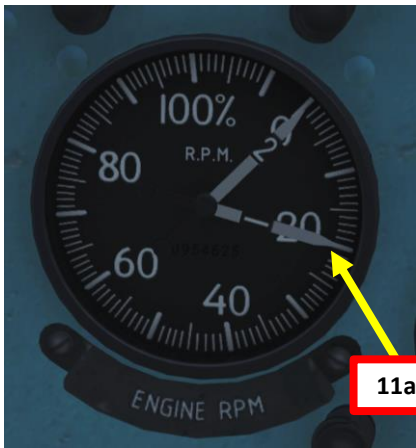
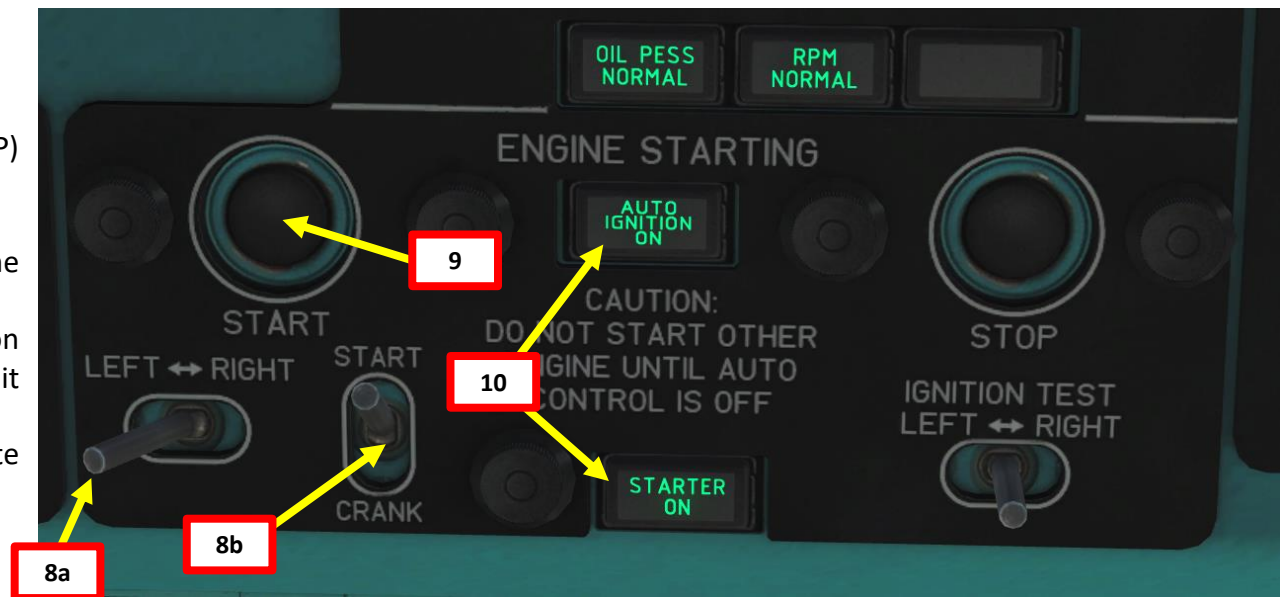



**START-UP (LEFT ENGINE START)**

Main Rotor Tachometer  
(% max RPM)

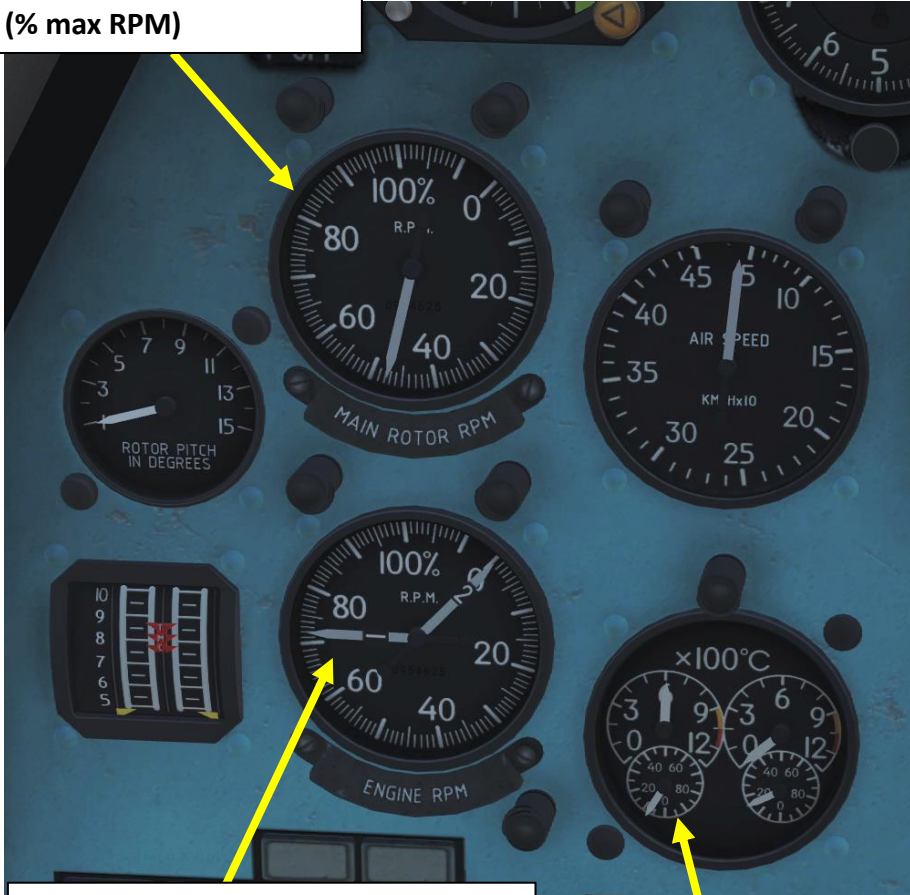

Engine N1 (Gas Turbine/Compressor Speed) Indicator (% max RPM)

PTIT (Power Turbine Inlet Temperature) Indicator (x100 deg C)

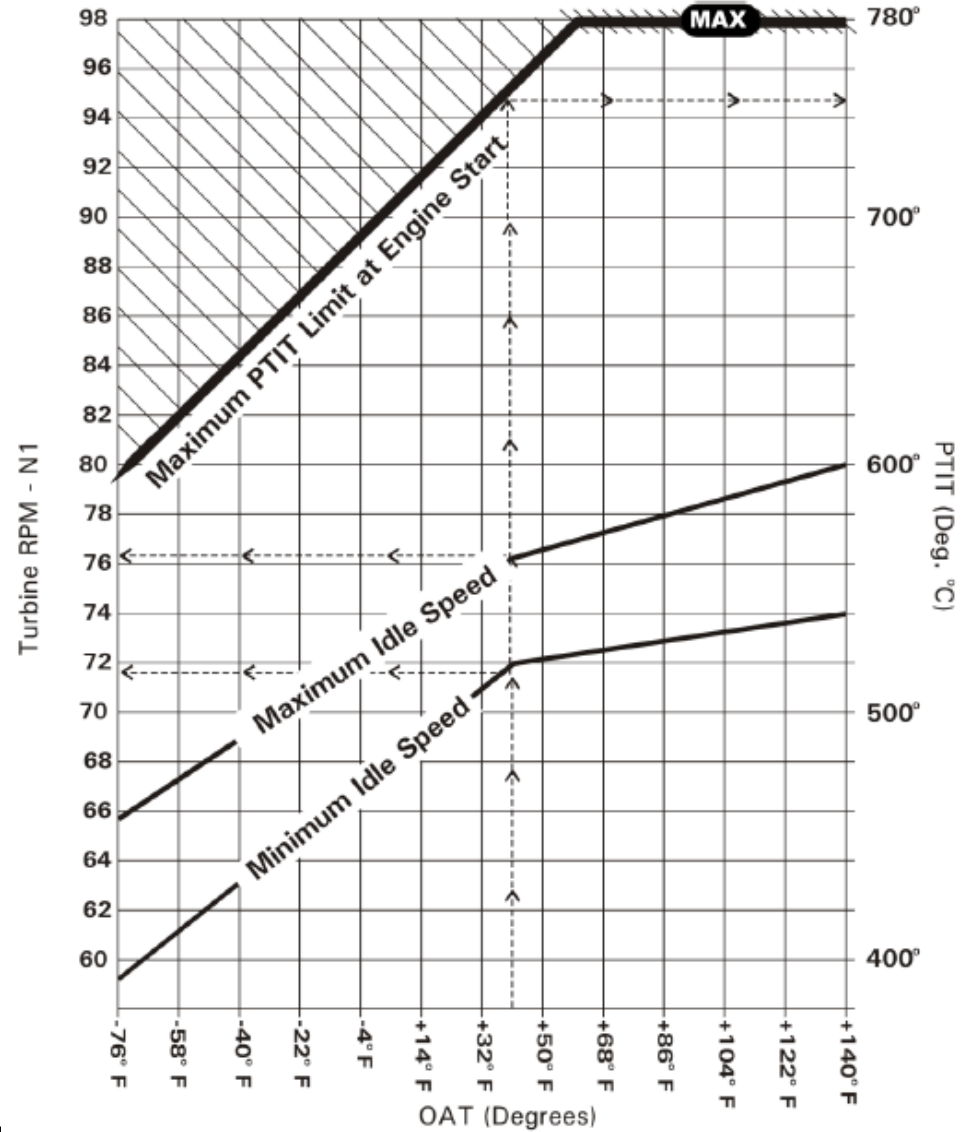

Example:

Enter the graph from the bottom, using the reported ambient temperature.  
 Ambient Temperature: +41° F  
 N1 Minimum = 72%  
 N1 Maximum = 76%  
 PTIT Maximum = 745° C



Maximum Idle N1/Starting Temperature



## START-UP (RIGHT ENGINE START)

13. Select Right Engine.
14. Press “START” button for 2 to 3 seconds to initiate start sequence.
15. Confirm good engine start: engine oil pressure should increase, and the AUTO IGNITION ON and STARTER ON annunciators should be visible.
16. Once Engine N1 (Gas Turbine/Compressor Speed) increases, click on right/selected engine red fuel shutoff lever (“Engine Stop”) to push it forward. Fuel flow will kick in and engine N1 will increase to IDLE speed (70-75 % RPM).
17. When both engines reach IDLE RPM, Main Rotor Speed should be between 45 and 70 % RPM.



16a



16b



13

16c

17

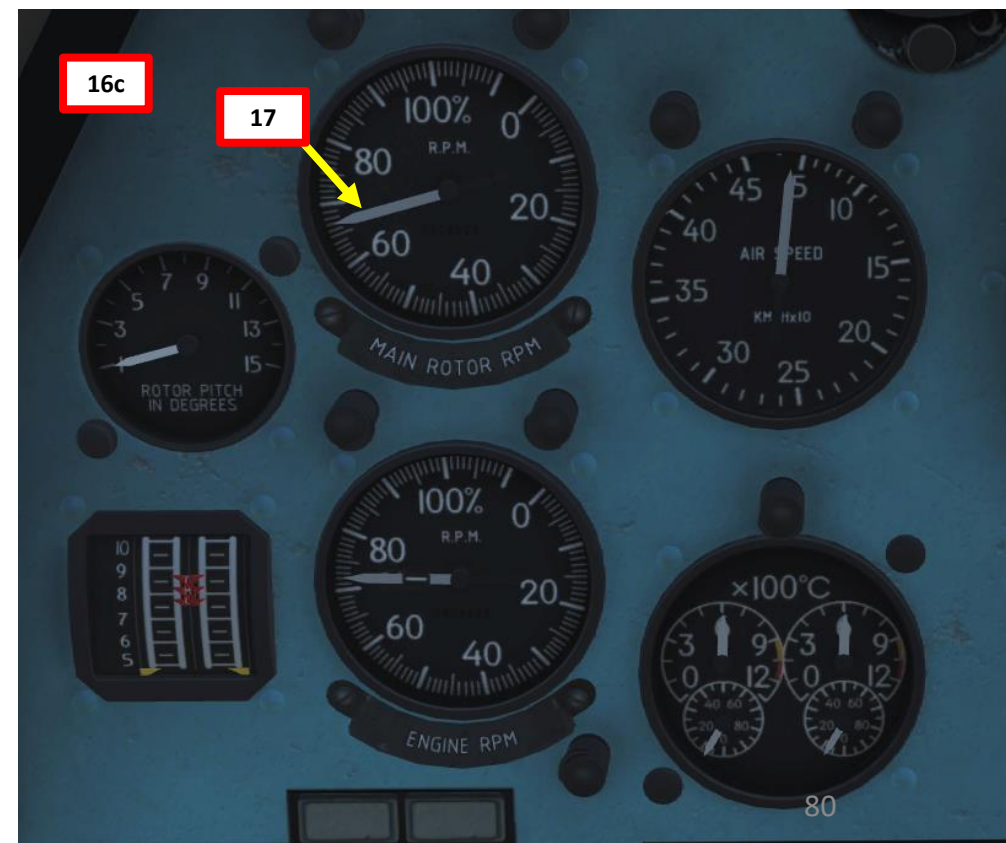

80



## START-UP (ENGINE RUN-UP)

18. Increase engine power to Nominal Engine Power setting by turning the Twist Grip Fully Right (MAX) by using the “Page Up” binding.
19. When the Twist Grip is set to MAX, it will engage the Governor system, which will maintain Main Rotor Speed to 95 % RPM.
20. Confirm Main Transmission Gearbox oil pressure and temperature stabilize to nominal values, and that Intermediate Transmission Gearbox and Tail Transmission Gearbox oil temperatures stabilize to nominal values.

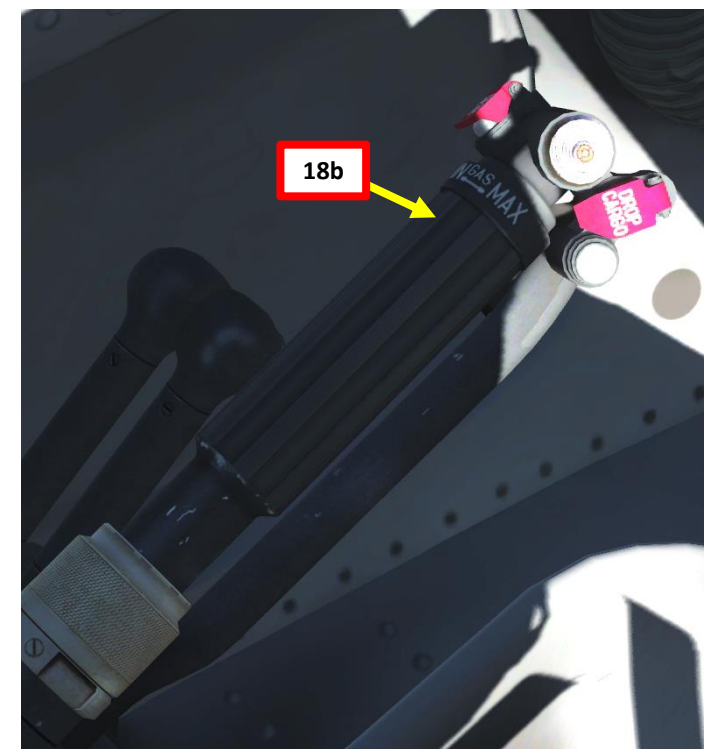
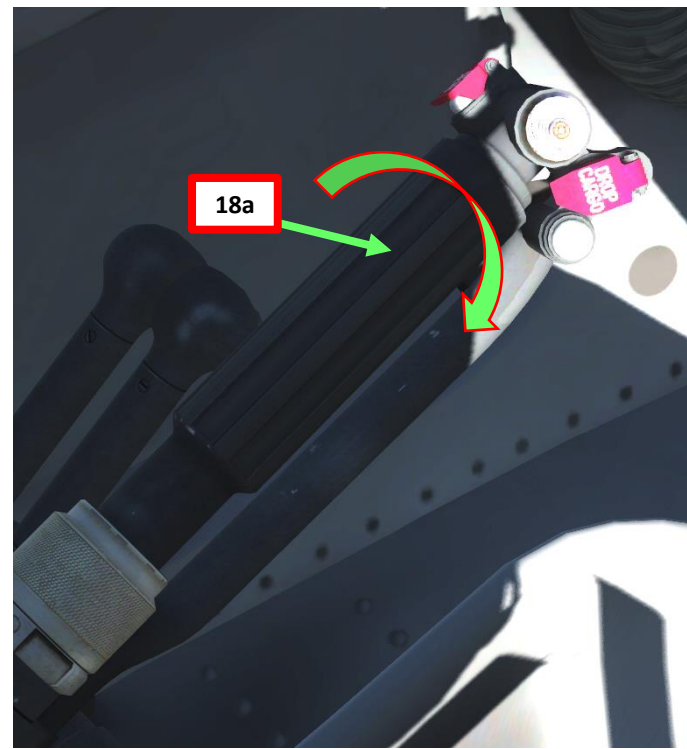



## START-UP (ENGINE POST-START)

21. Set Engine Start Selector to MIDDLE (Neutral).
22. Generators #1 & #2 – ON (UP)
23. Rectifiers #1, #2 & #3 – ON (UP)
24. 36V & 115V Inverters – AUTO (DOWN)
25. Press APU OFF button
26. Left Attitude Indicator – ON (UP)
27. Gyro Cut-Out Switch – ON (UP)
28. Voice Warning System – ON (UP)
29. Tail Rotor Pitch Limiting System – ON (UP)
30. Doppler System Power switch – ON (UP)
31. Doppler System Mode Switch - OPERATE (РАБОТА) (behind co-pilot seat)
32. YaDRO-1A radio – ON (UP)
33. Gyrocompass System – ON (UP)
34. Right Attitude Indicator – ON (UP)
35. Navigation Lights – ON (UP)
36. Formation Lights – ON (UP)
37. Blade Tip Lights – ON (UP)
38. Anti-Collision (Strobe) Light – ON (UP)
39. Left & Right Pitot Heat switches – ON/UP (as required)

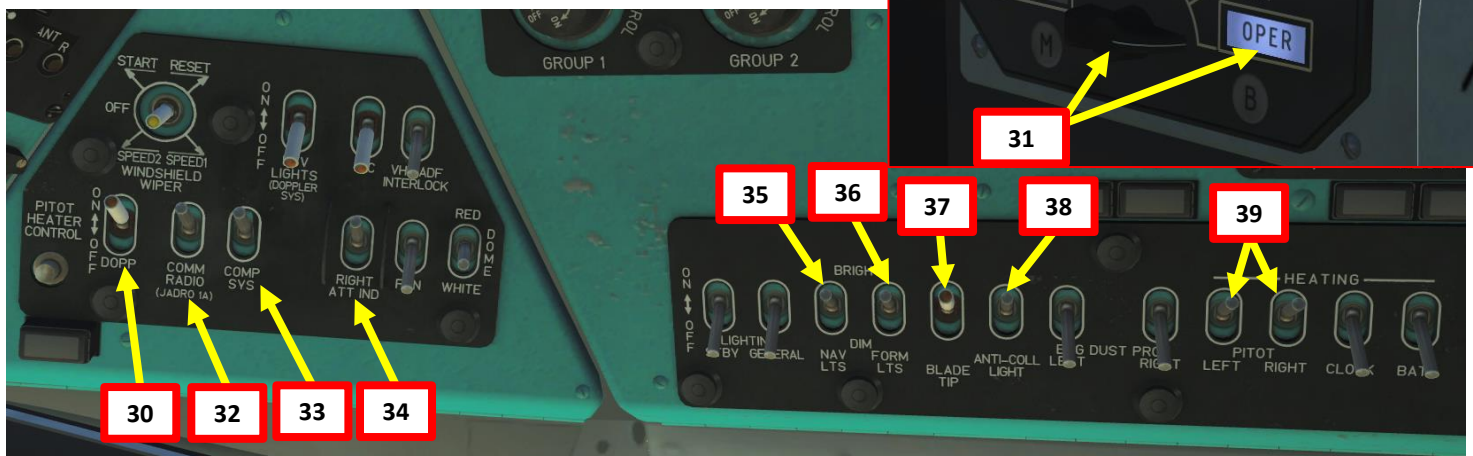
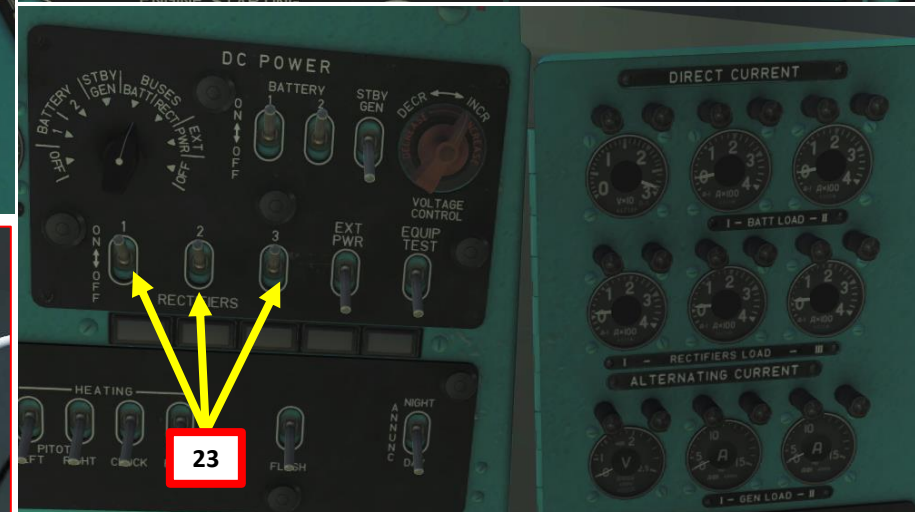
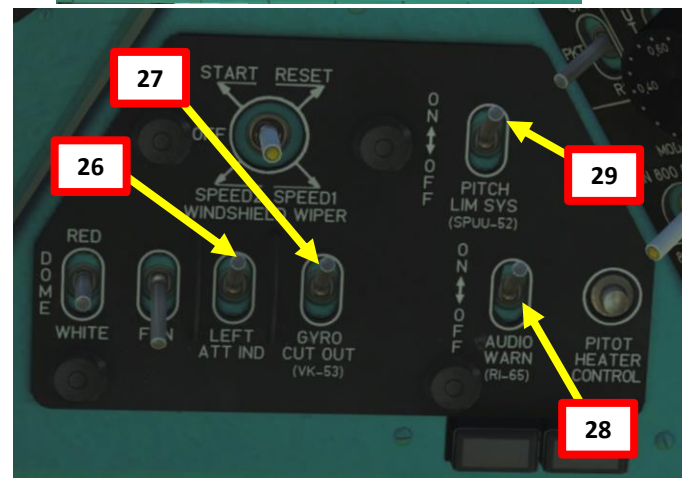
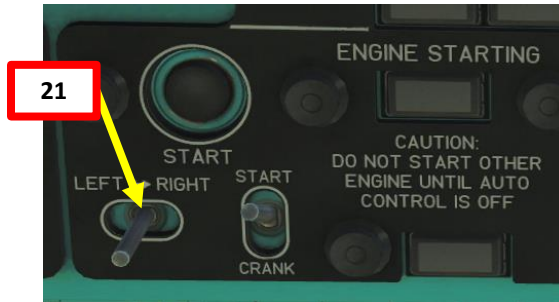



## START-UP (ENGINE POST-START)

40. Engage Pitch & Roll Autopilot Channels of the AFCS (Automatic Flight Control System) by pressing the Pitch/Roll Push-Lamp (Green = ON)
41. Confirm that the Main Hydraulic System is active (MAIN SYS ON annunciator) and that you have positive hydraulic pressure.
42. Radar Altimeter – ON (UP). The Radar Altimeter will then automatically perform a self-test. During this test, the radar altimeter will display 800 m.
43. Once Radar Altimeter Test is complete (30 sec approx.), the LOW ALTITUDE WARNING light will illuminate.
44. Rotate (mousewheel scroll) yellow Radar Altimeter Index Setting knob until the index reaches 0 m. The warning light will then extinguish.
45. Press the Accelerometer RESET button
46. Tap the Wheel Brake Lever (binding: “W”) to release parking brake.  
**Note:** Parking Brake can be engaged again by pressing “LSHIFT+W”

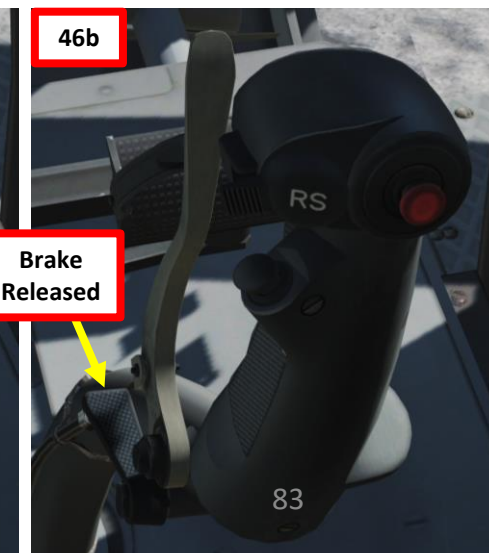
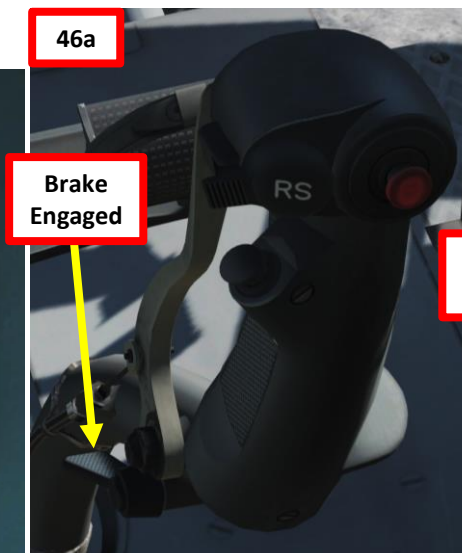
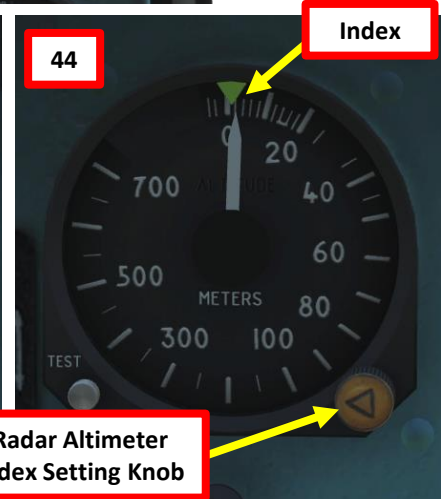
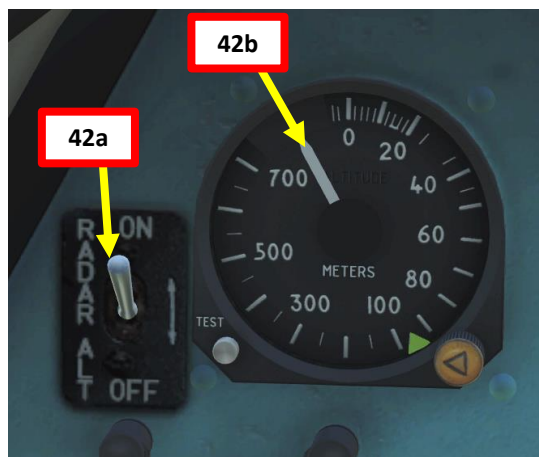
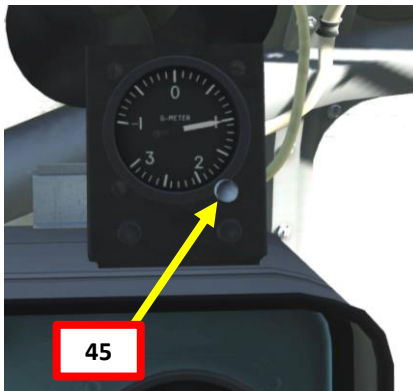
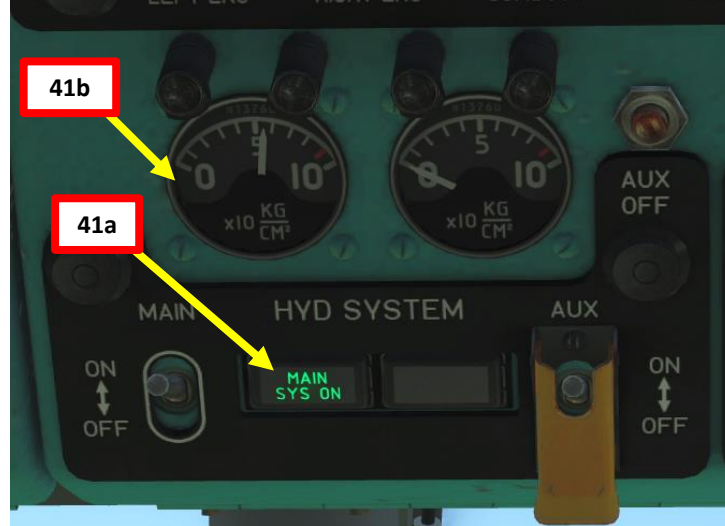



# START-UP (ENGINE POST-START)

- 47. Close Side Blister Windows
  - Left : LCtrl+C
  - Right: LShift+C

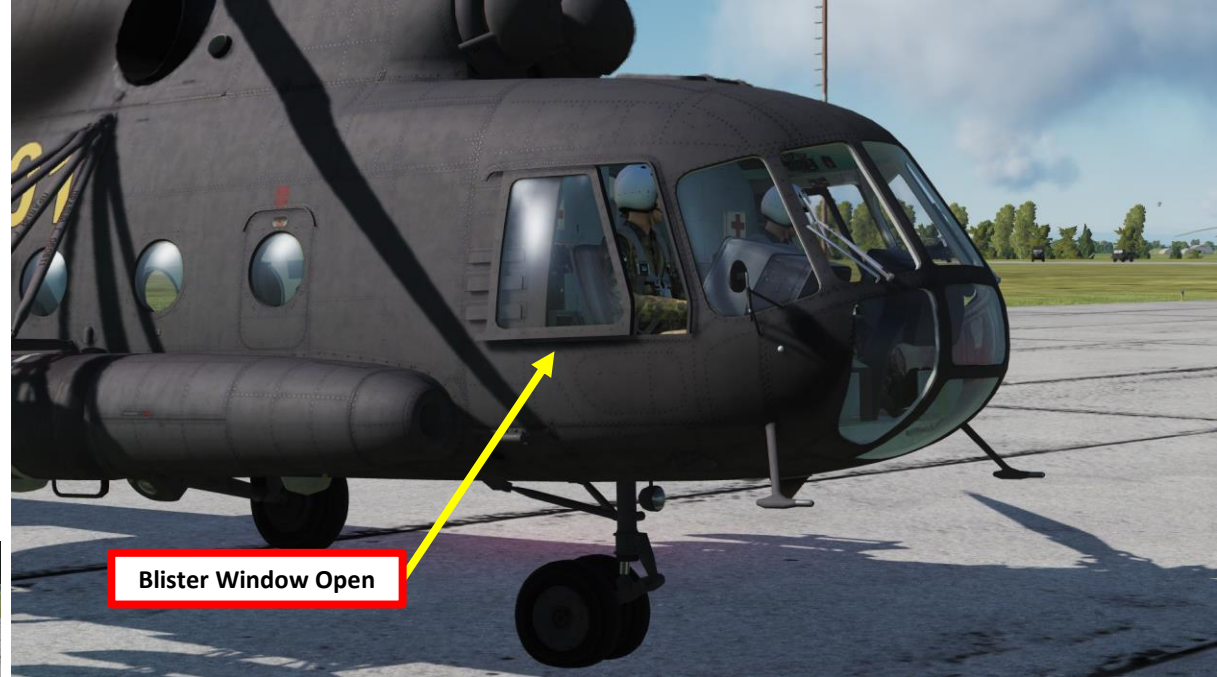



## REARMING

To contact the ground crew to rearm the Mi-8 in DCS, you have to switch the lower right switch (No. 5) on the SPU-7 to the "ICS" position (UP).



Рис. 9.89. SPU-7 control panel:

1 – "ОБЩАЯ" (MASTER) and "ПРОСЛ" (MONITOR) volume control knobs to set volume of internal and external comms.; 2 – rotary selector to select source to monitor:

"УКР" (UHF) – R-863 UHF/VHF radio set

"СР" (HF) – YaDRO-1A radio set

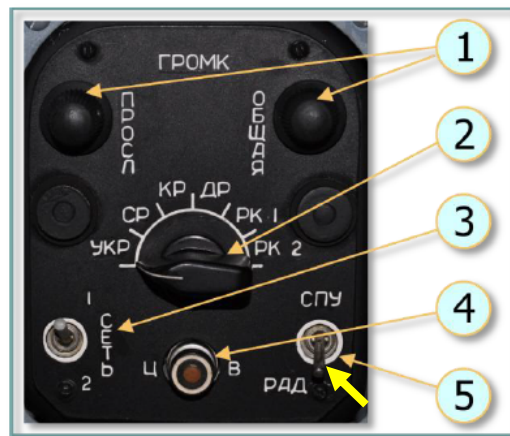
"КР" (VHF) – R-828 UHF radio set

"ДР" (SW) – not utilized

"РК 1" (ADF) – ARK-9 ADF set

"РК 2" (SAR) – ARK-UD VHF homing set

СЕТЬ 1-2 (NET 1-2) - not utilized

4 – "ЦБ" (ALL CALL) button for transmission of emergency messages. When pressed, interphone signal is transmitted to all ICS station at doubled volume level, audio warning messages are transmitted with maximum volume level; 5 - "СПУ-РАД" (ICS-RADIO) selects communication via ICS or the selected radio.

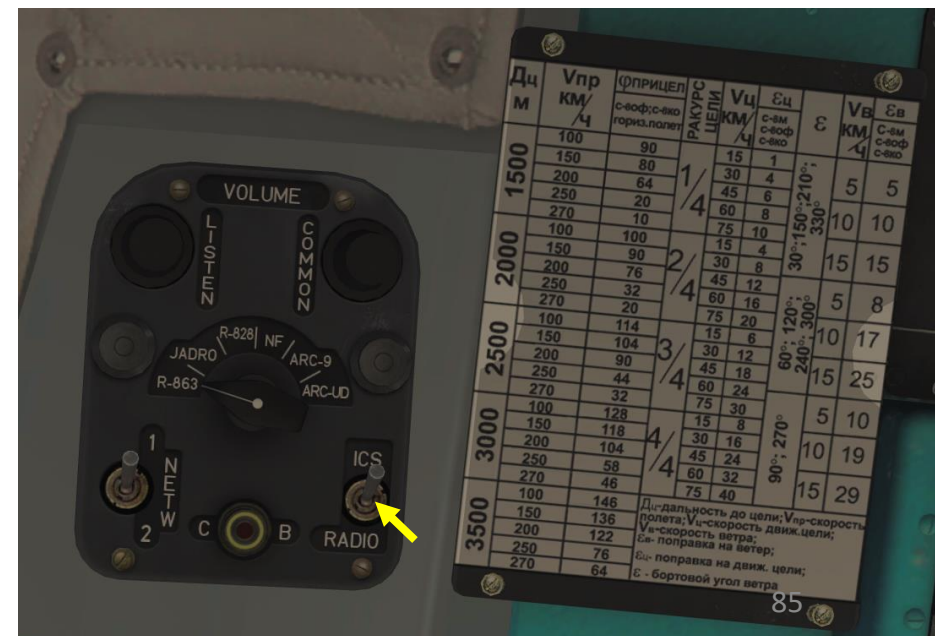



**HOW TO HOVER**

1. Apply right pedal to stay centered and avoid drifting.
2. Use cyclic to remain straight and level (right & aft input).
3. Raise collective very gently to initiate a hover.
4. Hovering is hard at first. Failure to predict the helicopter's reaction after cyclic input will often result in you dancing the French Cancan for a looong long time. Think of it like doing plate-spinning: you need to put yourself in a position of equilibrium, so you always need to think one step ahead.
5. Hold the "TRIMMER" button (on your cyclic) and your stick will remember that "hover" position. Keep in mind that trim works a bit differently from a plane's trimming.
6. Anticipate the rotorcraft's reaction when you trim.

**Hover and Low Speed Control Indicator**

- Vertical Speed: m/s
- Horizontal Speed: km/h





## TAKING OFF

NOTE: There are many ways to takeoff in a Mi-8. The best way is generally a function of your loadout, weight and mission.

1. Check that all your engine and transmission gauges (pressure & temperature) are within safe operation range.
2. Check to see if all your flight instruments all set up properly.
3. Once you have performed a hover check and are maintaining a 3 m hover, you can taxi to the runway. In the Mi-8, you do not need to hover in order to taxi: just push your cyclic forward to force the front wheel to touch the ground, very gently raise the collective to move forward and use your brake lever and anti-torque pedals to steer the helicopter on the ground.
4. When lined up, set RPM to at least 92 %.
5. Push nose slightly forward to start gaining horizontal speed. No collective input should be required since you are already in a hover state. This is the normal takeoff and the safest procedure. You can also attempt a maximum performance takeoff, which will be more taxing on the rotor blades and can end in tragedy if you are too heavily loaded or the environmental conditions don't allow for it. I recommend using the normal takeoff since you are very unlikely to fly at empty weight. You're better off being safe than sorry.
6. **NORMAL TAKEOFF:** Keep accelerating and you will start generating more and more translational lift, naturally climbing. Try to maintain an airspeed of 120 km/h when climbing.

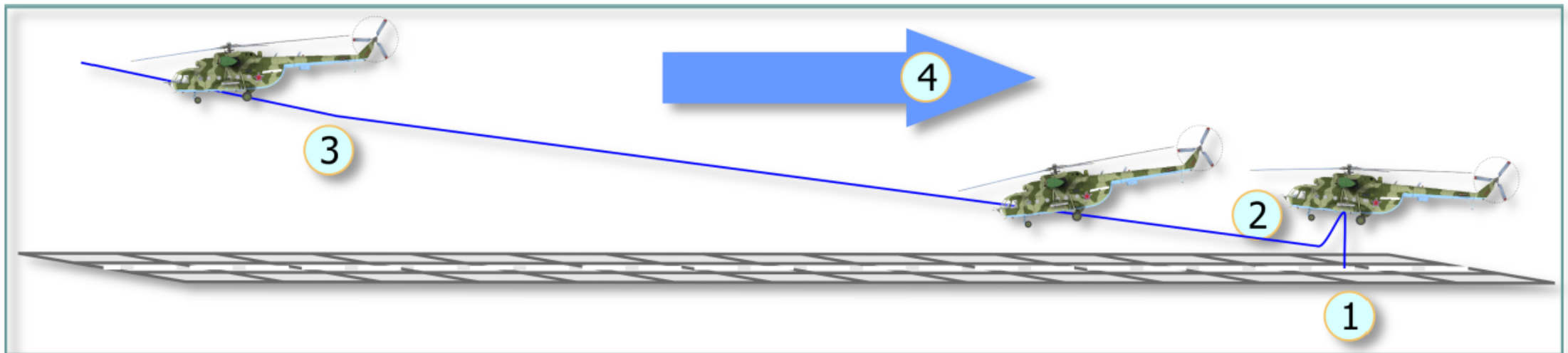
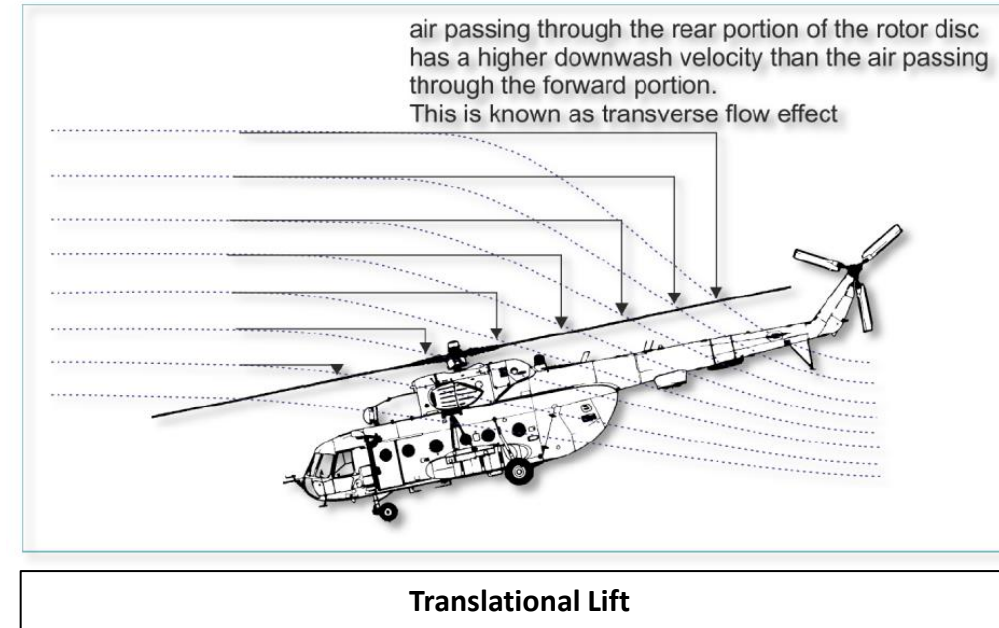

**Vertical Takeoff with Acceleration In Ground Effect**



# TAKING OFF

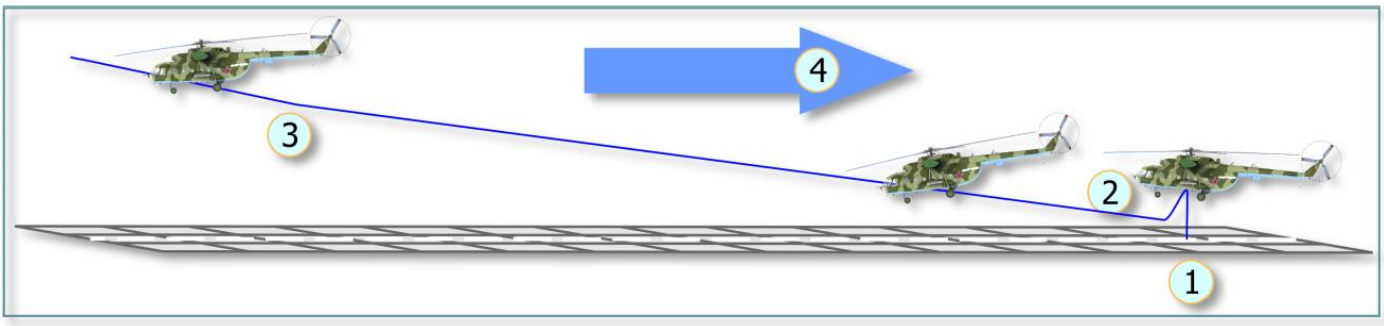

Vertical Takeoff with Acceleration In Ground Effect

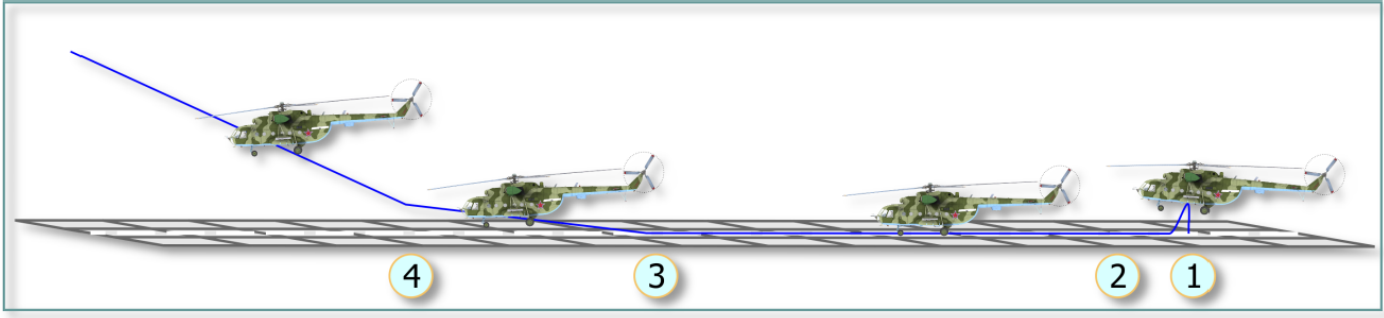

Running Takeoff

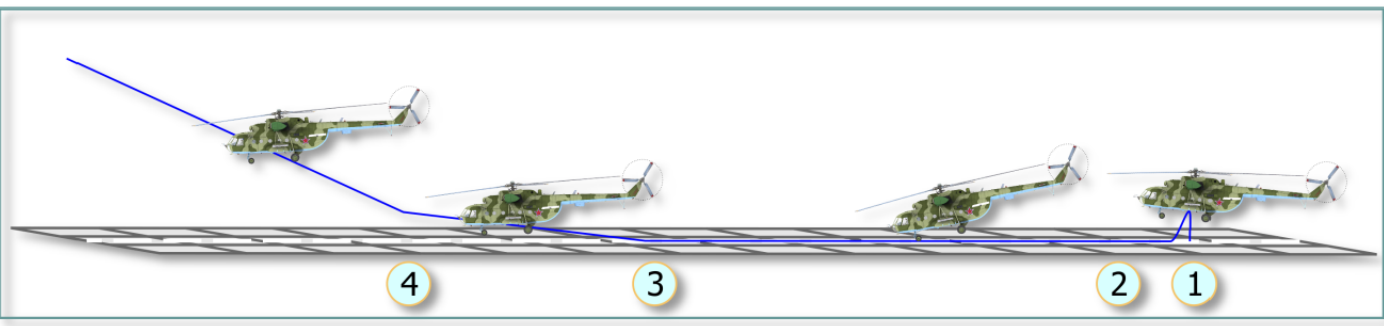

Running Nose Gear Takeoff

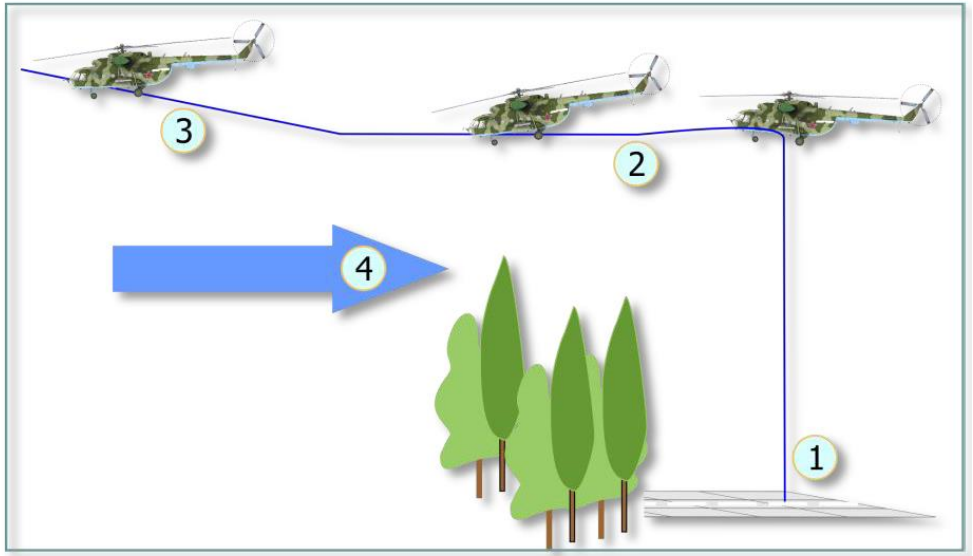

Vertical Takeoff with Acceleration Out of Ground Effect



## VISUAL LANDING

NOTE: When you think about it, a helicopter is usually landed like an aircraft: you maintain a descent rate, reach a touchdown point and pull back on your cyclic to bleed speed and come to a full stop. There are many different types of approaches. Your approach and landing type will depend on the type of LZ (landing zone) and the type of mission you are doing.

- 1) Start descent from 500 m. Fly towards a reference point on the runway. Pay particular attention to the Vortex Ring State (state in which the helicopter is settling in its own downwash and gets sucked down, which is caused by a flight profile of forward flight less than ETL (Effective Translational Lift, helicopter is slower than 40 km/h). VRS is further explained in Part 9: Principles of Helicopter Flight.
- 2) Use collective and cyclic input to maintain 120 km/h for a descent rate between 3-5 m/s
- 3) Reduce speed to 60 when you are 100 m: you will start feeling excess lift being generated by ground effect. Adjust collective to keep a straight trajectory towards your reference point while reducing airspeed.
- 4) You should reach your reference point in a 3 m hover. Use your cyclic to come to a full stop, and raise your collective to “cushion” the sudden drop caused by the loss of translational lift (which is caused by the loss of airspeed).
- 5) Once you have come to a full stop in a 3 m hover, you can slowly reduce collective to safely land on the ground.

NOTE: It takes a lot of practice to be able to counter the different flight states you will go through when coming for an approach and landing. This is why performing hover power checks before takeoff is very useful: it helps you master the hover state.



Plan the turn to final so the helicopter rolls out on an imaginary extension of the centerline for the final approach path. This path should neither angle to the landing area, as shown by the helicopter on the left, nor require an S-turn, as shown by the helicopter on the right.

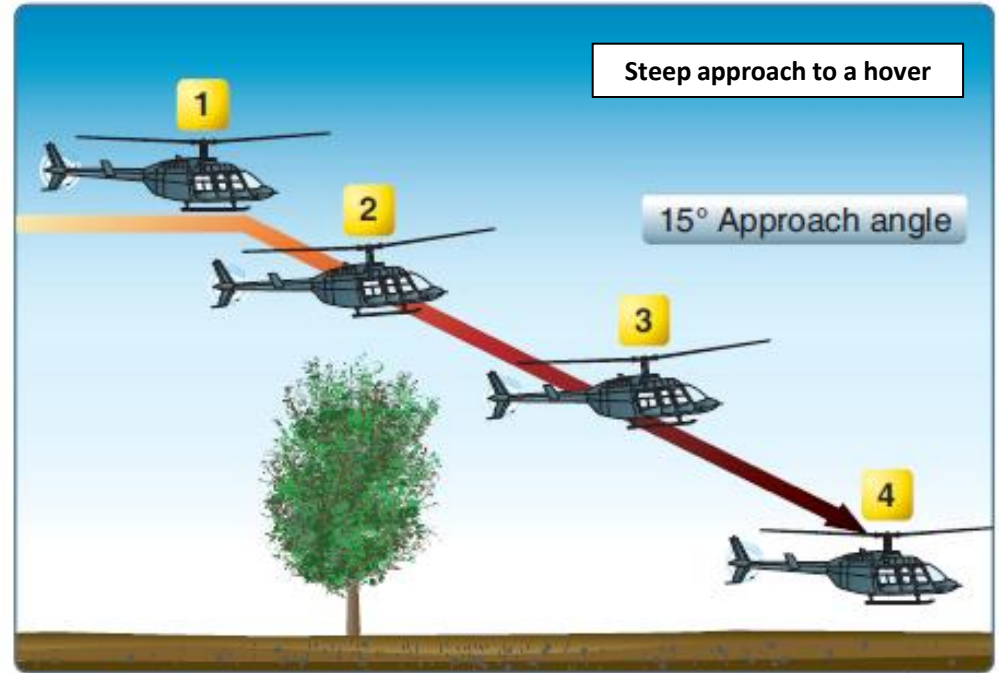
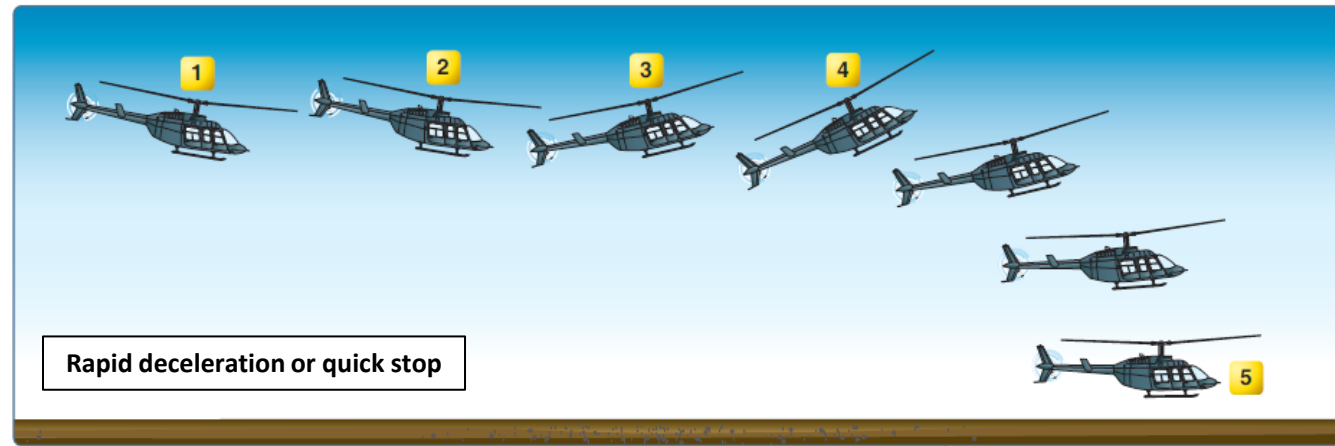
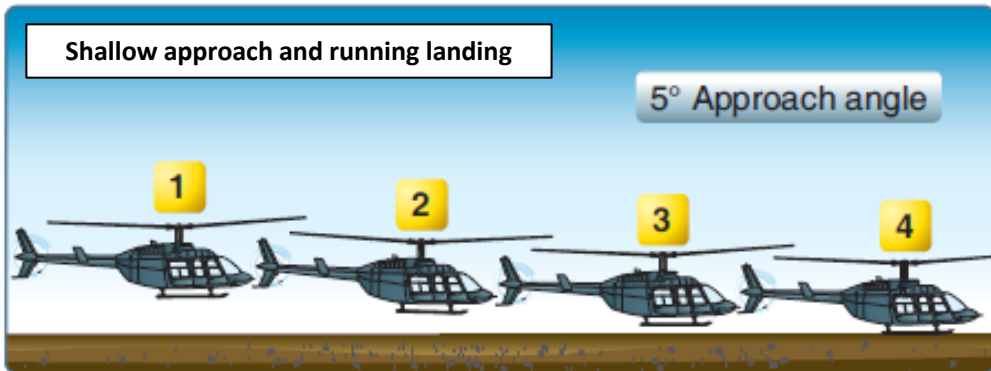
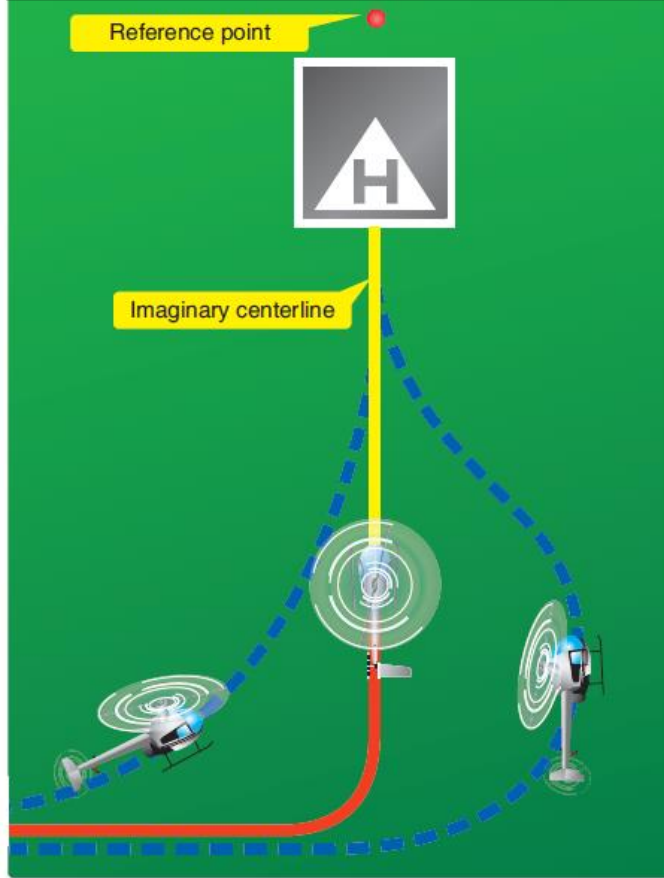



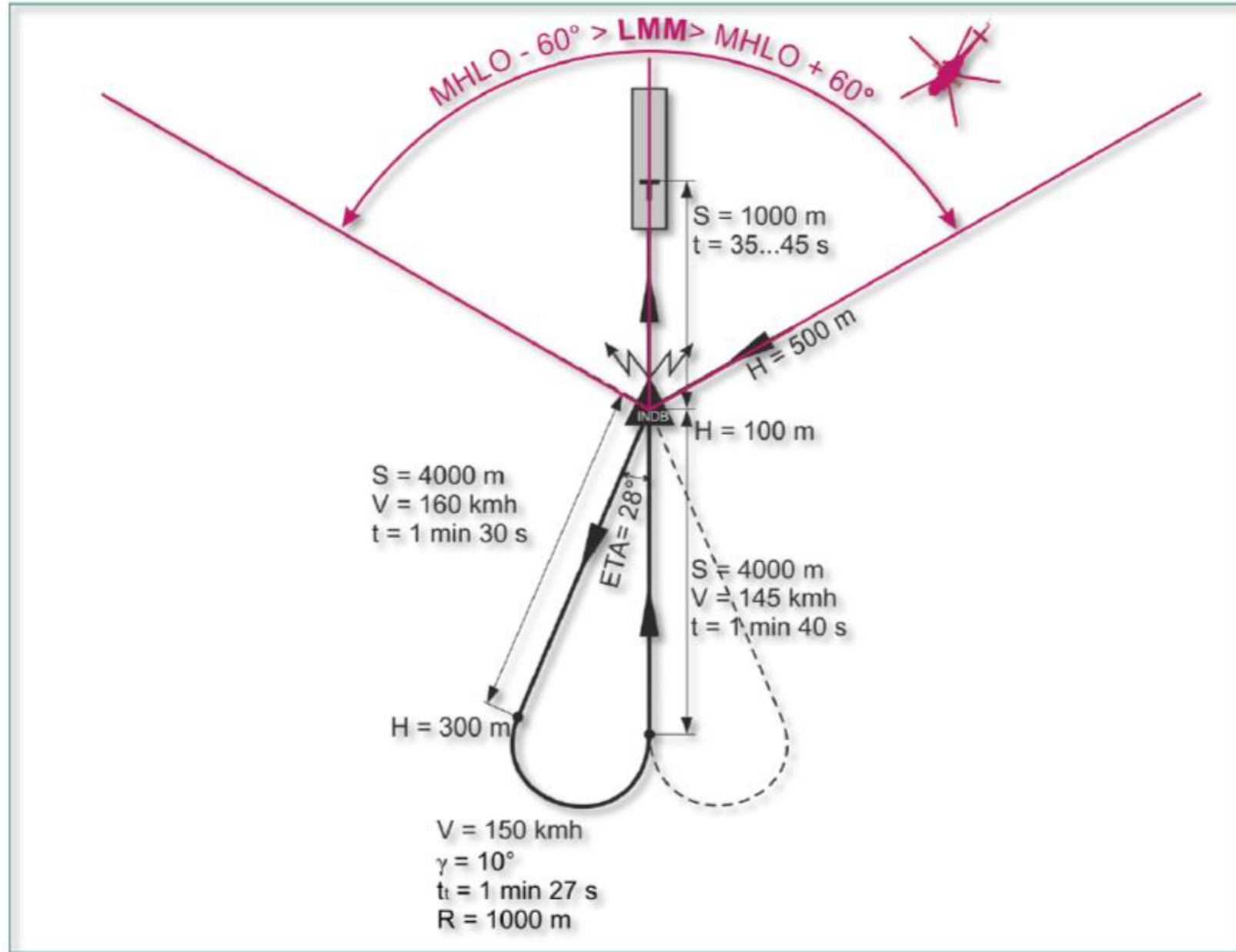

$V_{GS}$  (Ground Speed) = 160 km/h  
 $V_S$  (Vertical Speed) = 2-3 m/s  
 Approach Ground Speed (AGS) = 150 km/h  
 Roll Angle = 10 deg

- S - Distance
- V - Airspeed
- H - Altitude
- γ - Bank angle
- t - Time
- t<sub>t</sub> - Turn time
- RB - NDB radio bearing
- DA - Drift angle
- MRB - Magnetic radio bearing to beacon
- MH<sub>L</sub> - Magnetic landing heading
- FD - Flight direction

Straight In Approach with a Teardrop Procedure Turn Diagram



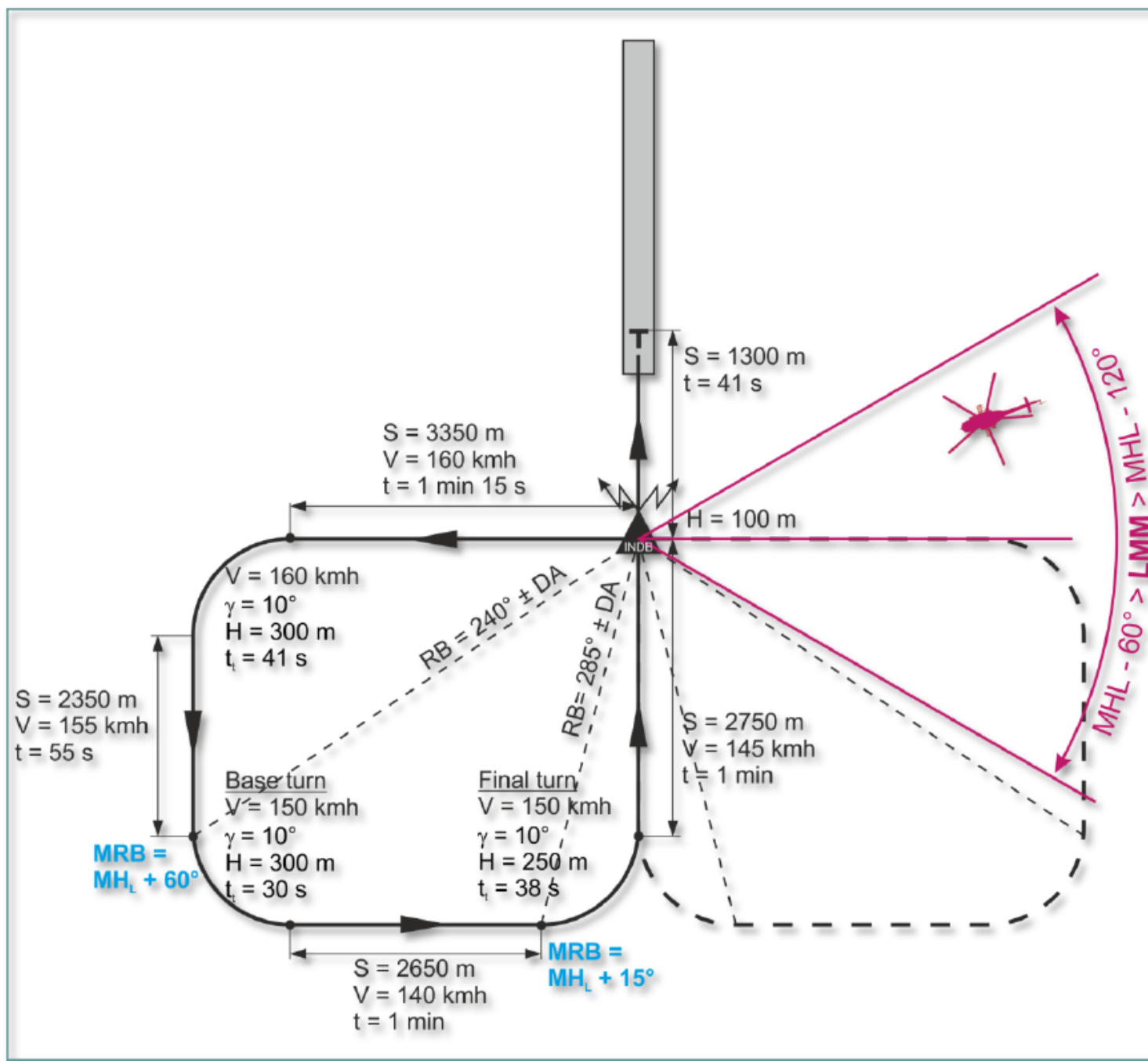

- S - Distance
- V - Airspeed
- H - Altitude
- $\gamma$  - Bank angle
- t - Time
- $t_t$  - Turn time
- RB - NDB radio bearing
- DA - Drift angle
- MRB - Magnetic radio bearing to beacon
- $\text{MH}_L$  - Magnetic landing heading
- FD - Flight direction

Tight Rectangle Pattern Diagram



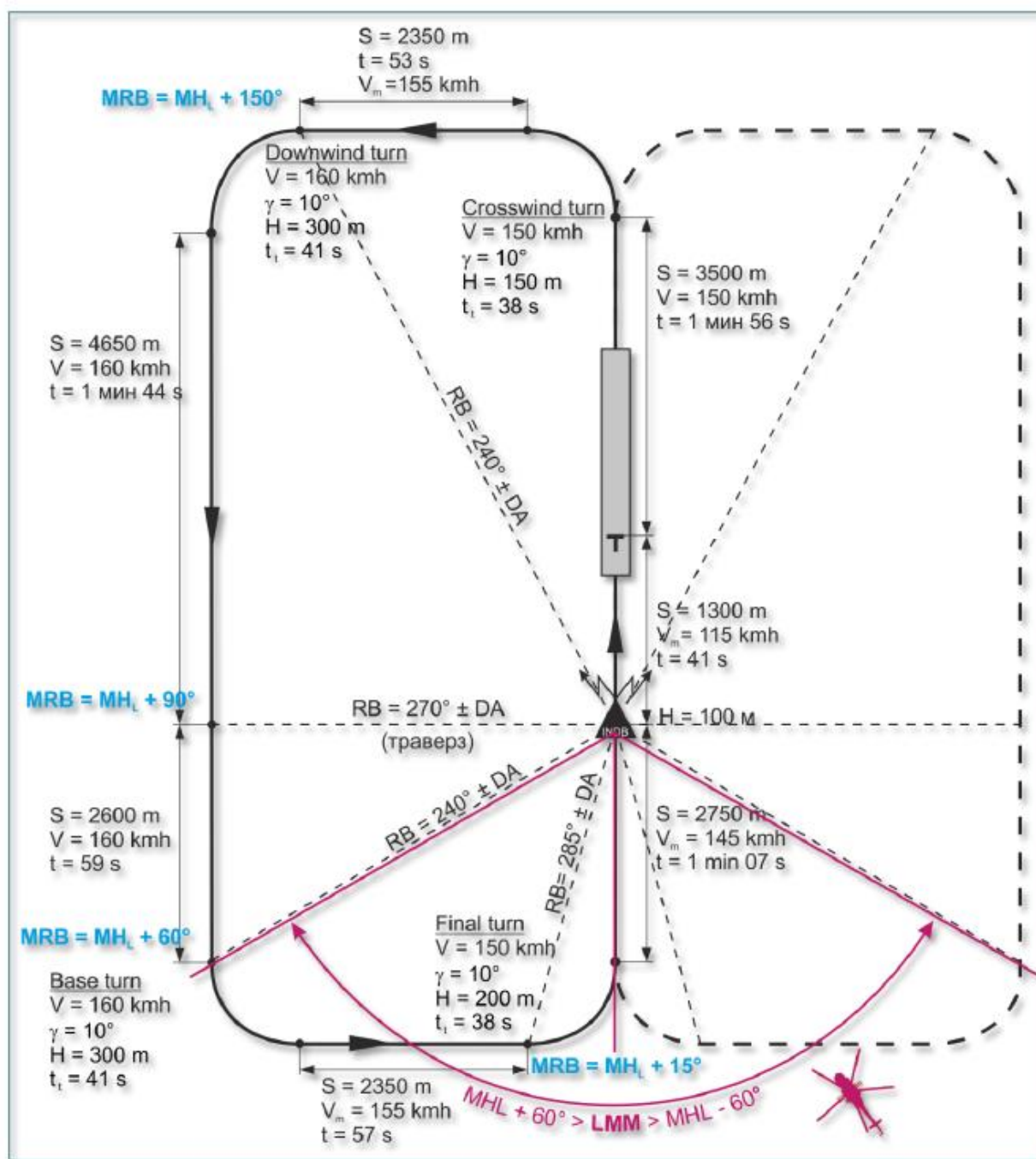

- S - Distance
- V - Airspeed
- H - Altitude
- $\gamma$  - Bank angle
- t - Time
- $t_t$  - Turn time
- RB - NDB radio bearing
- DA - Drift angle
- MRB - Magnetic radio bearing to beacon
- $MH_L$  - Magnetic landing heading
- FD - Flight direction

Wide Rectangle Pattern Diagram



## ENGINE SHUTDOWN

1. Aircraft position – Into the Wind
2. Parking Brake – Set
3. Chocks – As required
4. AFCS/Auto-Pilot – OFF
5. Taxi/Search light – As Required
6. SPUU-52 T/R pitch limiter – OFF
7. RI-65 audio warning system – OFF
8. Gyros/Erect cutout/compass switches – OFF
9. Dust protectors (PZU) – OFF
10. Blinking system flash switch – OFF
11. EHSI/Avionics – OFF
12. Rectifiers 1, 2, 3 – OFF
13. AC generators 1, 2 – OFF
14. Throttle – FULL LEFT (IDLE 2 MIN)
15. Fuel Shutoff Levers – Closed
16. Engine coast down – 50 seconds minimum
17. Rotor brake – As required (< 20 % Nr)
18. Fire EXT system – TEST (DOWN)
19. Fuel fire shutoff valves – OFF (0 % N1)
20. Fuel boost pumps – OFF
21. Fuel Indicator gauge – OFF
22. Instrument transformer switch – OFF
23. 115V & 35V inverter – OFF (CENTER)
24. Anti-collision light – OFF
25. Miscellaneous switches – OFF
26. Radar Altimeter – OFF
27. Parking brake – RELEASE
28. Cockpit/Instrument lights – OFF
29. DC selector knob – OFF
30. Batteries 1 and 2 - OFF

## SECTION STRUCTURE

- POWERPLANT
  - TV3-117VM Powerplant Introduction
  - Engine Controls
  - Engine Indications
  - Engine Operation Limits
  - Engine Protection Systems
    - N1 Governing Loop
    - N2 Governing Loop
    - PTIT Limiter
    - Generator Failure
    - Synchronizer
  - PZU: PSS (Particle Separator System) / DPD (Dust Protection Device)
- FUEL SYSTEM
- HYDRAULIC SYSTEM
- ELECTRICAL SYSTEM
- ANTI-ICE SYSTEM
  - Overview
  - Ice Detection
  - Particle Separator System Integration
  - Bleed Air & Electrical Heating Components
  - Rotor Anti-Ice
- FIRE PROTECTION SYSTEM
  - Operation
  - Indication & Alarm System Check
- KO-50 KEROSENE COMBUSTION HEATER SYSTEM



## POWERPLANT – TV3-117VM ENGINE INTRODUCTION

The Mi-8MTV2 helicopter powerplant consists of two Klimov TV3-117VM free-turbine turboshaft engines, assisted with the AI-9V APU (Auxiliary Power Unit). The engines are installed on the fuselage deck in a common nacelle with the oil cooler fan of the air cooling system.

The "VM" in TV3-117**VM** stands for "high altitude, modernized". It was initially designed for the Mi-28 helicopter, and later installed also on Mi-8MT/Mi-17 models. This engine features an automatic switch to emergency power.

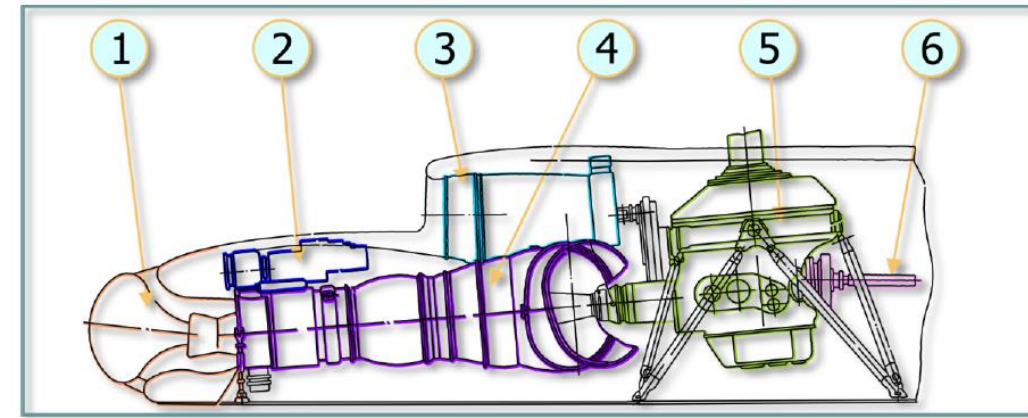

**Fig. 4.2. Powertrain system diagram (side view)**

1. Engine inlet and particle separator head ("PZU");

4. TV3-117VM engine;  
5. VR-14 main transmission;

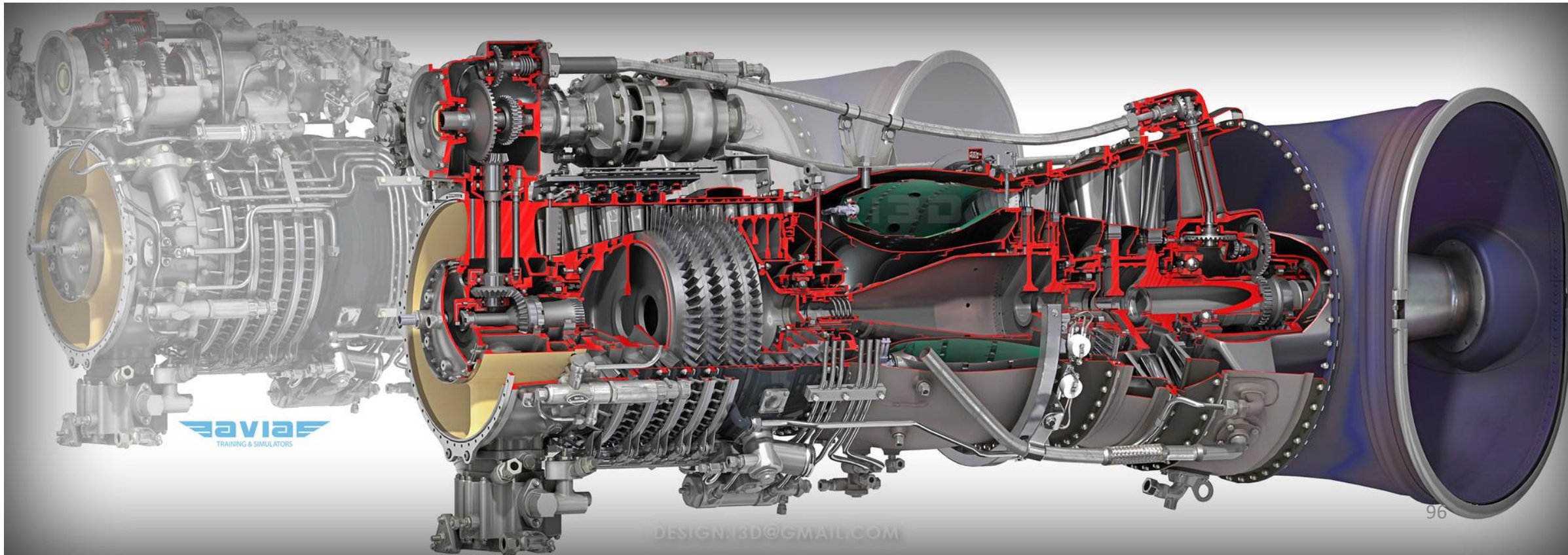

**POWERPLANT – ENGINE CONTROLS**

Joint engine operation is controlled using the twist grip throttle control on the pilot or copilot collective sticks. The engines are controlled individually by the pilot’s engine condition levers (ECLs). If one engine fails when the engines are operating at power settings above flight idle, as long as the collective pitch remains unchanged, the droop compensator will engage and automatically bring the operating engine to MAX RATED (or Emergency) Power Setting to maintain the main rotor RPM. If the automatic control systems fail, the engine power setting can be controlled by manual adjustment of the twist grip throttle, the collective pitch, and the engine condition levers to maintain the main rotor RPM.

Engine control is mostly automated and the pilot typically adjusts power settings with the collective while the throttle twist grip is rarely used at all unless in emergency situations.

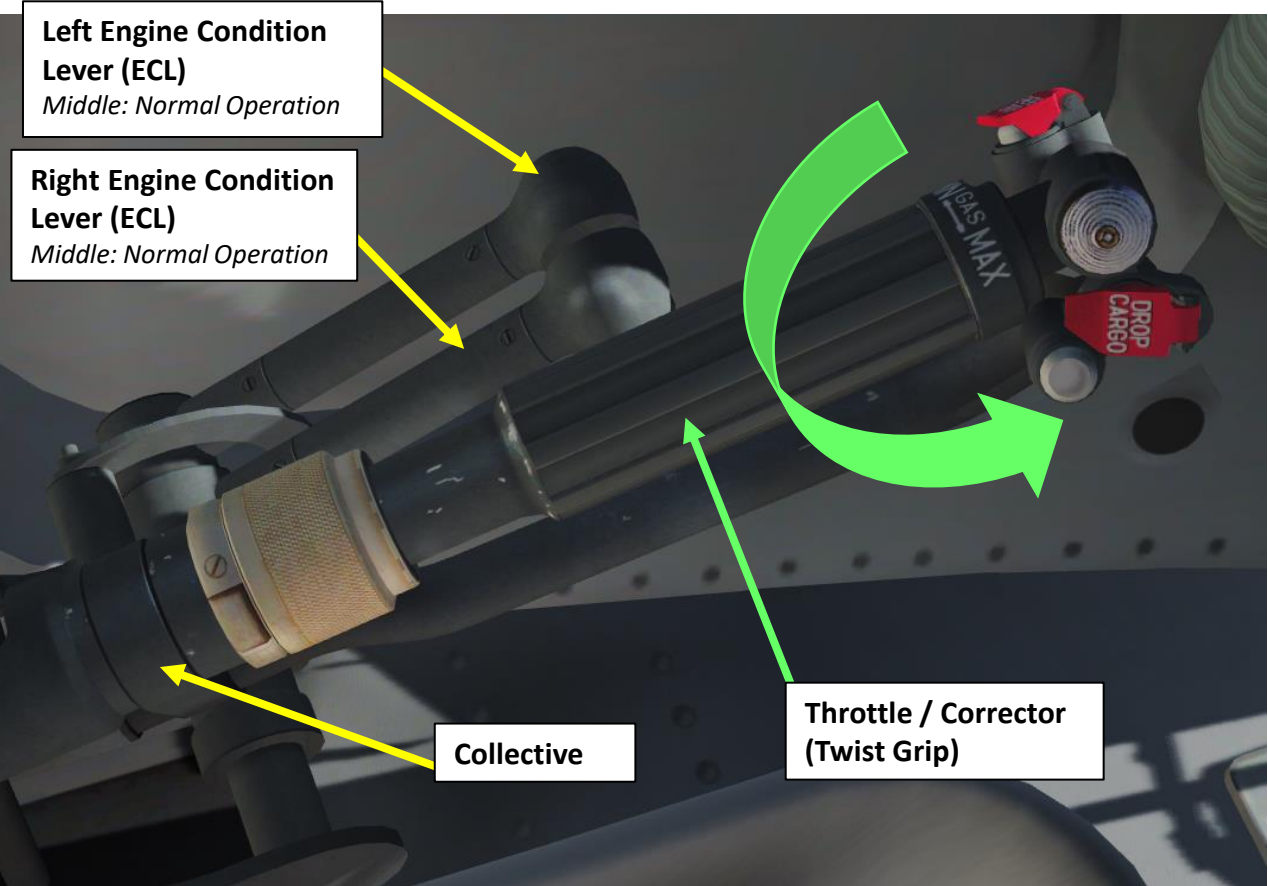

**Engine N2 Trim Control**

The engine control system includes a manual adjustment for N2 RPM. The pilot introduces trim changes with the INCR-DECR switch on the collective stick.

The switch is a three-position type and is held in the INCR (UP) position to increase the power turbine speed or down to the DECR position to decrease the power turbine speed.

The trim adjustment range is from 91 +/- 2 % to 97 +/-1%.

The Engine Condition Levers (ECL) and manual trim control are used to control engines during engine testing and during special flight conditions (i.e. single engine failure) to adjust the Main Rotor RPM (NR) to 95 %RPM, which is the nominal value it should be running at.





**POWERPLANT – ENGINE INDICATIONS**

The four engine indications you should keep an eye on at all times are:

- N1 (Gas Turbine Speed) – used to monitor health and power setting of the engine
- NR (Main Rotor Speed) – used to monitor rotor overspeed or underspeed
- EPR (Engine Pressure Ratio) – used to define reference power settings for different phases of flight
- PTIT (Power Turbine Inlet Temperature) – must be monitored to prevent engine overheating

**N1 (Gas Turbine / Compressor Rotation Speed in %RPM)**

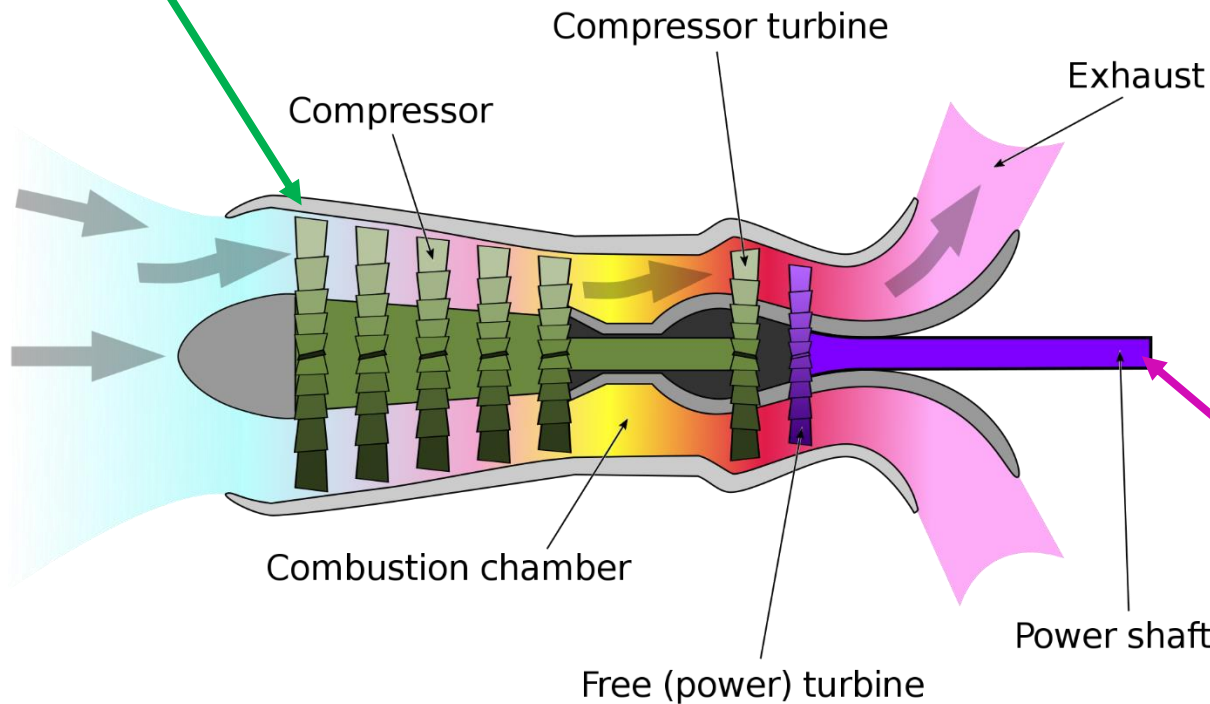

**Main Rotor Pitch Angle (deg)**

**EPR: Engine Pressure Ratio**  
*Amber Index: Current Power Setting*  
*O (T) Index: Takeoff Power Setting*  
*H (M) Index: Nominal Power Setting*  
*K (C) Index: Cruise Power Setting*

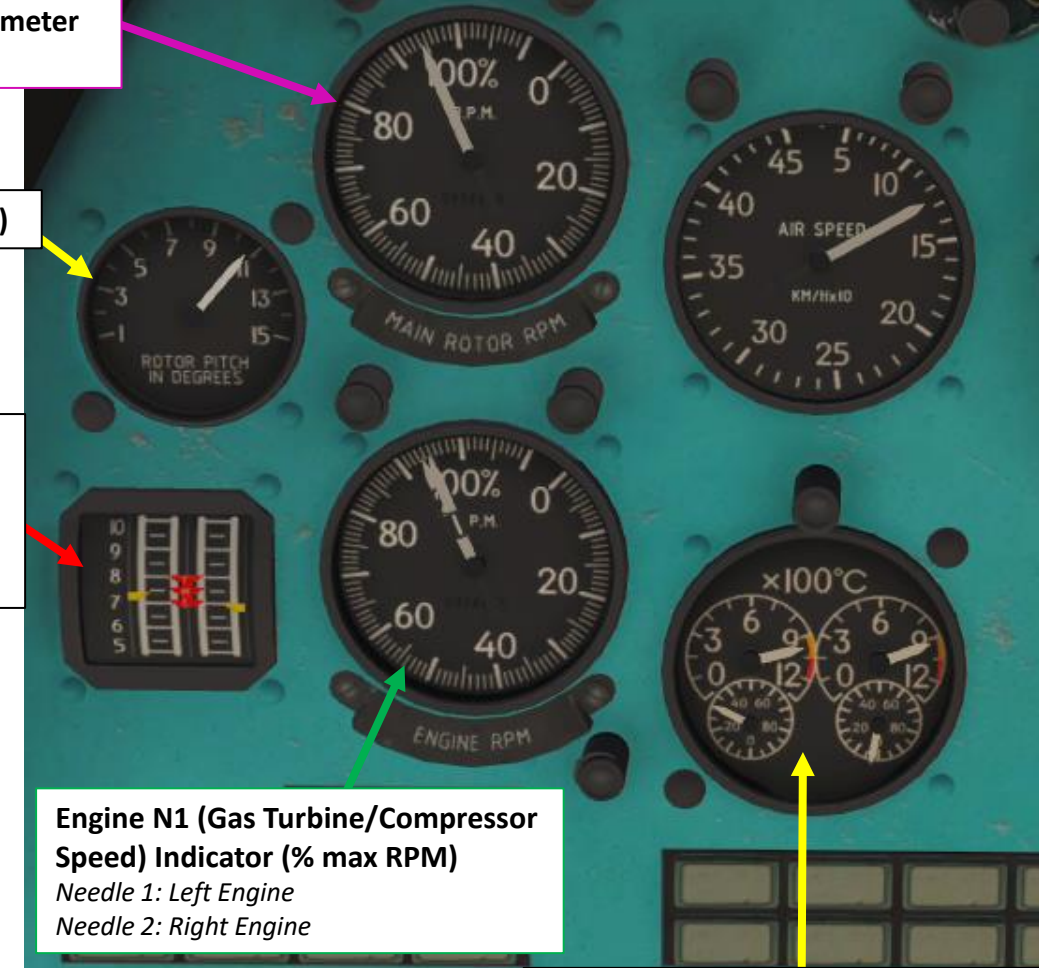

**Engine N1 (Gas Turbine/Compressor Speed) Indicator (% max RPM)**  
*Needle 1: Left Engine*  
*Needle 2: Right Engine*

**PTIT (Power Turbine Inlet Temperature) Indicator (x100 deg C)**

**N2 (Free Power Turbine Rotation Speed in %RPM)**  
 Incidentally, since the Power Turbine drives the Main Rotor shaft, in normal operation N2 is equal to the Main Rotor Speed (**NR**, in %RPM)

**POWERPLANT – ENGINE INDICATIONS**

Additionally, engine oil and various transmission gearbox oil indicators must be monitored once in a while to watch for oil leaks (which are often fatal issues if not found quickly, resulting in degraded transmission performance or even catastrophic transmission failure).

**TOP:** Main Transmission Gearbox Oil Pressure (kg/cm<sup>2</sup>)  
**LEFT:** Intermediate Gearbox oil temperature (deg C)  
**RIGHT:** Tail Rotor Gearbox oil Temperature (deg C)

**Main Transmission Gearbox Oil Temperature (x10 deg C)**

**Left engine oil temperature (deg C)**

**Right engine oil temperature (deg C)**

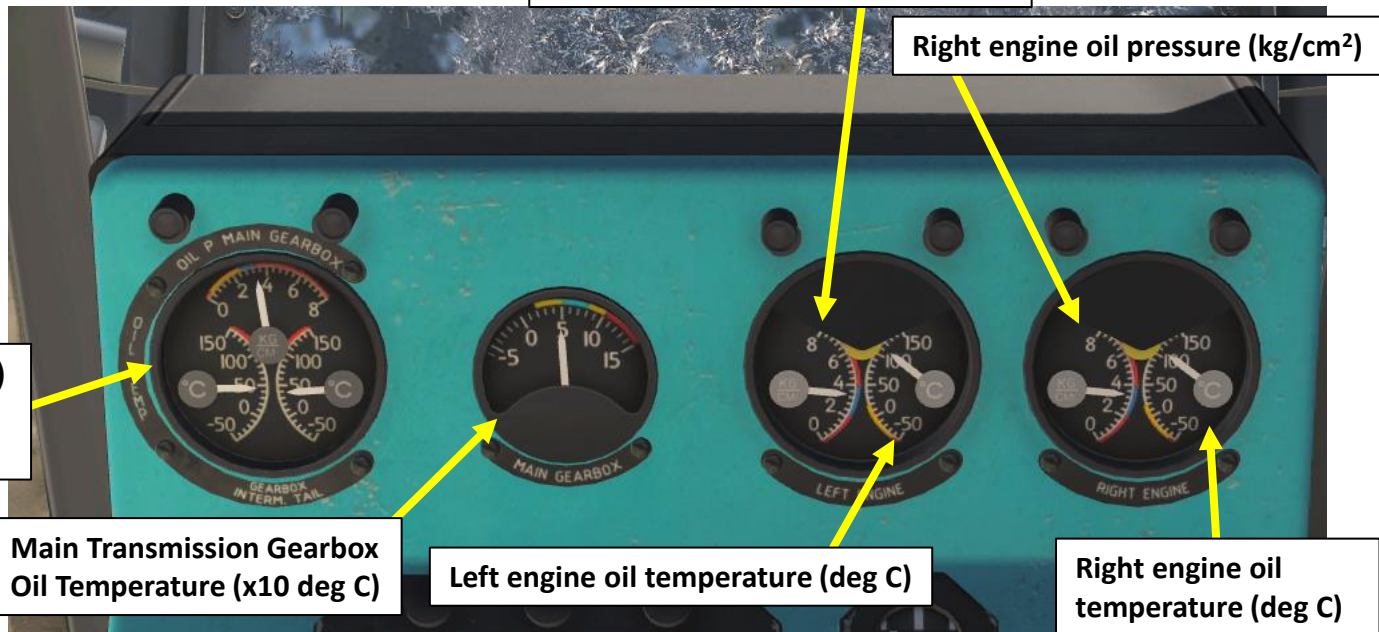

1. Oil Cooler Driveshaft
2. VR-14 Main Transmission
3. Tail Rotor Driveshaft
4. Intermediate Gearbox
5. Rear Tail Rotor Driveshaft Section
6. Tail Rotor Gearbox
7. TV3-117M Engine Driveshafts
8. Oil Cooler Fan

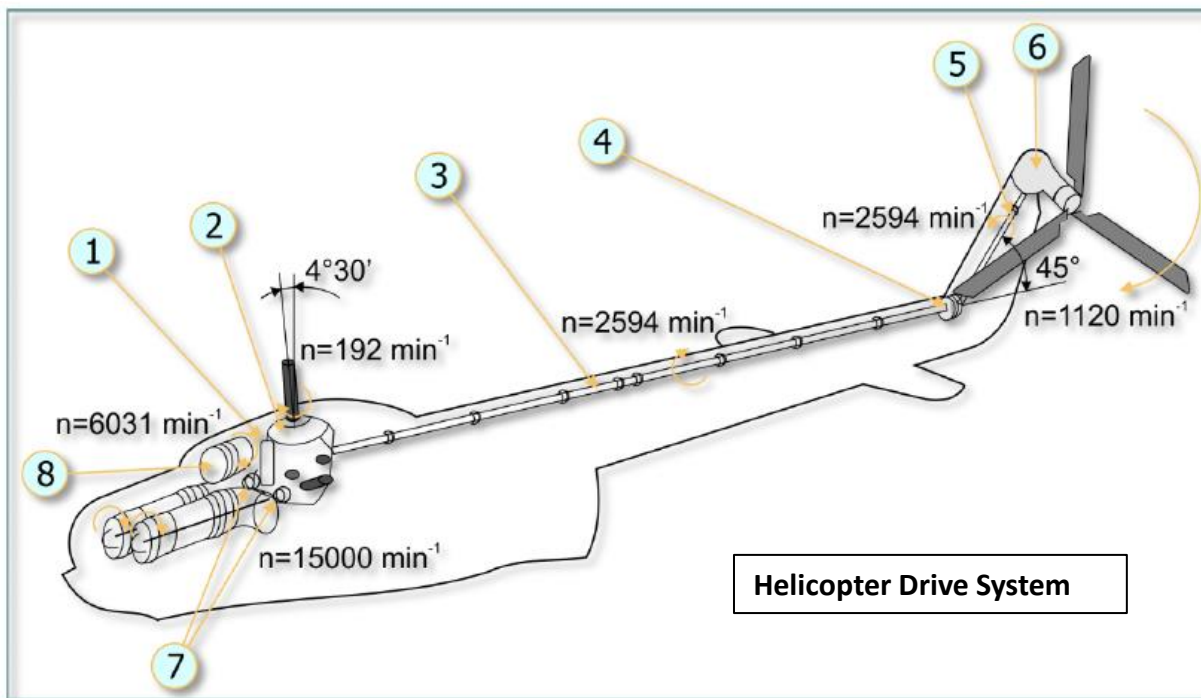





**POWERPLANT – ENGINE OPERATION LIMITS**

**Mi-8MTV2 Performance Limitations**

Max Takeoff Weight	13,000 kg
Max Speed	230 km/h
Max Main Rotor Speed	101 % for no more than 20 seconds
Max PTIT (Power Turbine Inlet Temperature)	880 deg C Normal Operation between 720-750 deg C)
Min Main Rotor Speed	88 % for no more than 30 seconds
Min Main Rotor Speed During Autorotation	70 %

**TV3-117VM Engine Maximum Operating Range Limits**

Power Setting	MAX PTIT (Power Turbine Inlet Temperature) Deg C	Max N1 % RPM
Max Rated	990	101.0
Takeoff	990	101.0
Max Limited Cruise	955	99.0
Limited Cruise	910	97.5
Cruise	870	95.5
Idle	780	Max Idle N1 Table Value

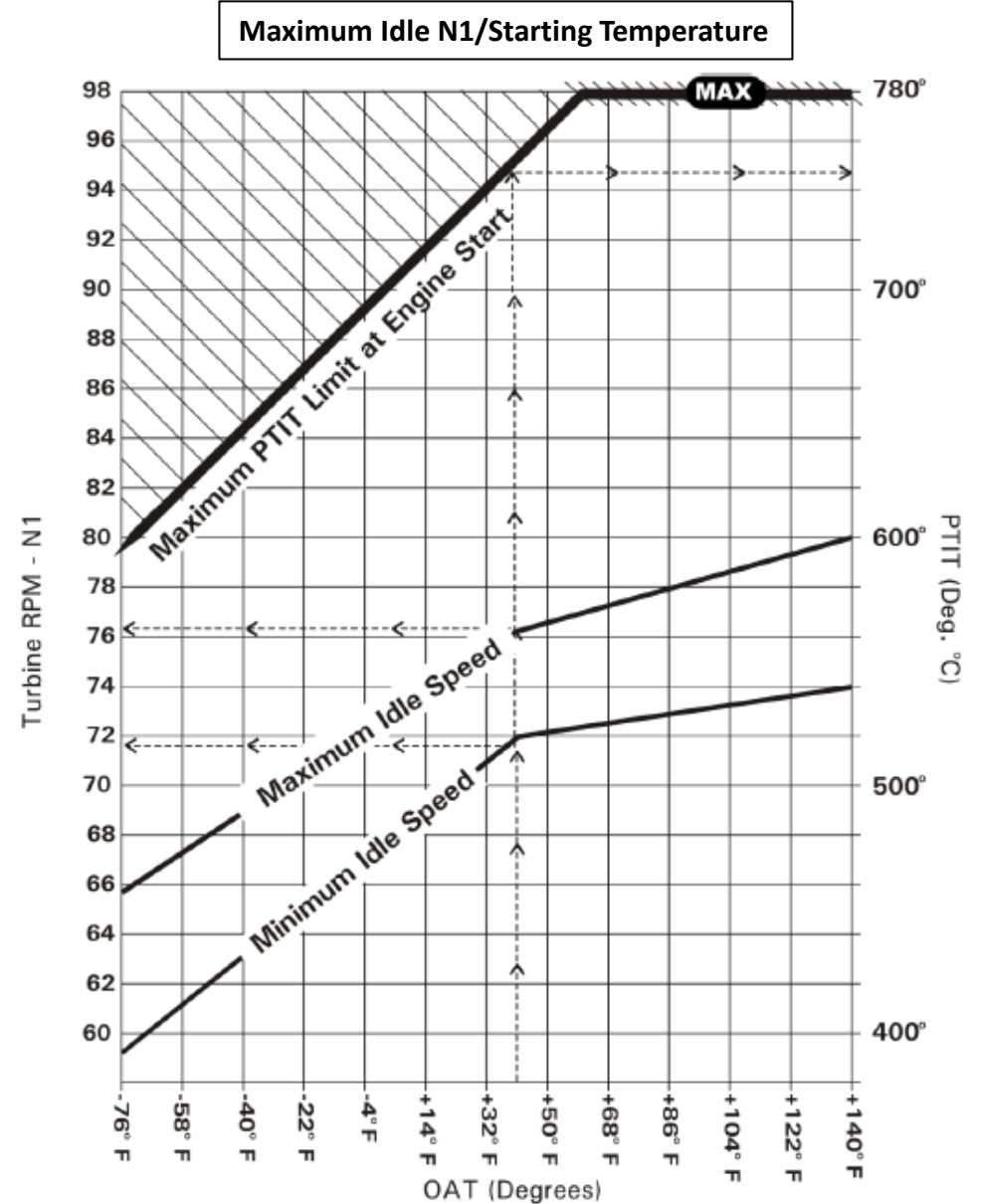

**Example:**

Enter the graph from the bottom, using the reported ambient temperature.  
 Ambient Temperature: +41° F  
 N1 Minimum = 72%  
 N1 Maximum = 76%  
 PTIT Maximum = 745° C



**POWERPLANT – ENGINE OPERATION LIMITS**

**TV3-117VM Engine Operating Range Table**

Power Setting	RPM			Oil Pressure (kg/cm <sup>2</sup> )	Engine Oil Temperature (deg C)				MAX Time Allowed (Minutes)
	N1	NR			MAX	Recommended	Min Oil Temp Continuous Operation	Min Initial Oil Temp	
		One Engine Operating	Two Engines Operating						
IDLE	Maximum Idle N1/Starting Temperature Table	40-55	55-70	>2	-	-	-	-	20
CRUISE	N1 must not exceed: • EPR Power Setting Index for desired power setting • Maximum Operating Range Limits (see previous page)	95 ± 2		3.5±0.5	150	80-140	70	30	No Limit
LIMITED CRUISE		95 ± 2		3.5±0.5	150	80-140	70	30	No Limit
MAX LIMITED CRUISE		95 ± 2		3.5±0.5	150	80-140	70	30	60
TAKEOFF		93 ± 1		3.5±0.5	150	80-140	70	30	6
MAX RATED		93 ± 1	-	3.5±0.5	150	80-140	70	30	See NOTE A

**Note A - MAX RATED Allowed Time**

Exceeding 6 minutes of operating time in the EMER (MAX RATED) /Take Off settings or the time limits for other power settings, will result in a reduction in engine service life.

**Note B – One Engine Operating**

When one engine has failed, the operating engine automatically elevates power to MAX Rated available. MAX Rated Power operating mode can not be activated for both engines simultaneously.

In other words, MAX Rated Power operating mode one of two engine can be activated only when the other engine failure (i.e. any action of the crew with (for) two simultaneously operating engines can not be set MAX Rated Power).

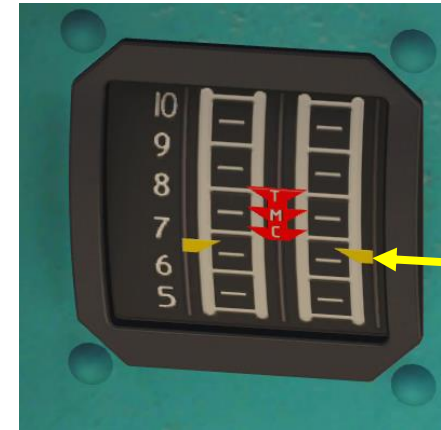

**EPR: Engine Pressure Ratio**  
 Amber Index: Current Power Setting  
 O (T) Index: Takeoff Power Setting  
 H (M) Index: Nominal Power Setting  
 K (C) Index: Cruise Power Setting





**POWERPLANT – ENGINE OPERATION LIMITS**

**CHART A: N1 Limits (%) Adjusted for Ambient Temperature**

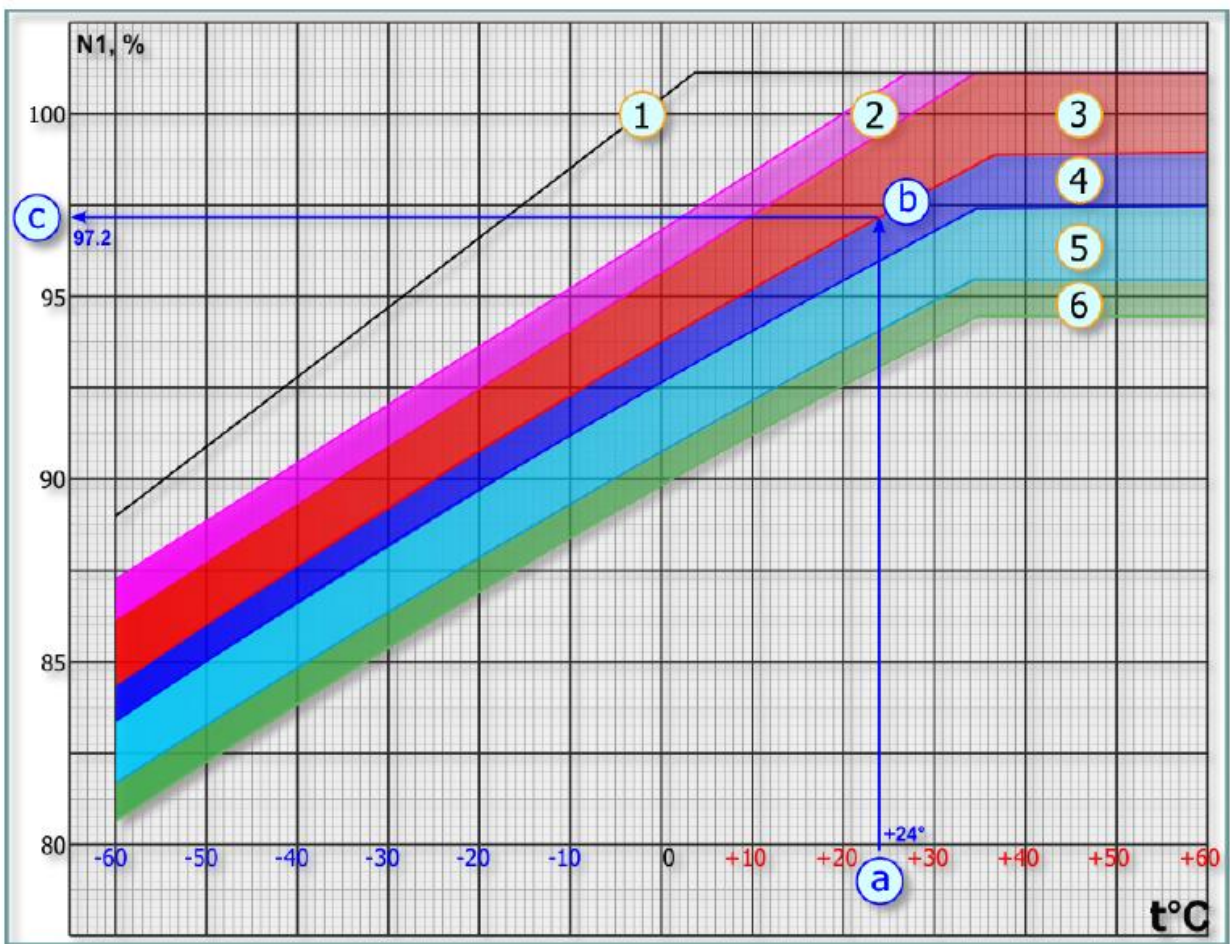

**CHART B: N1 (%) Adjusted for Barometric Pressure**

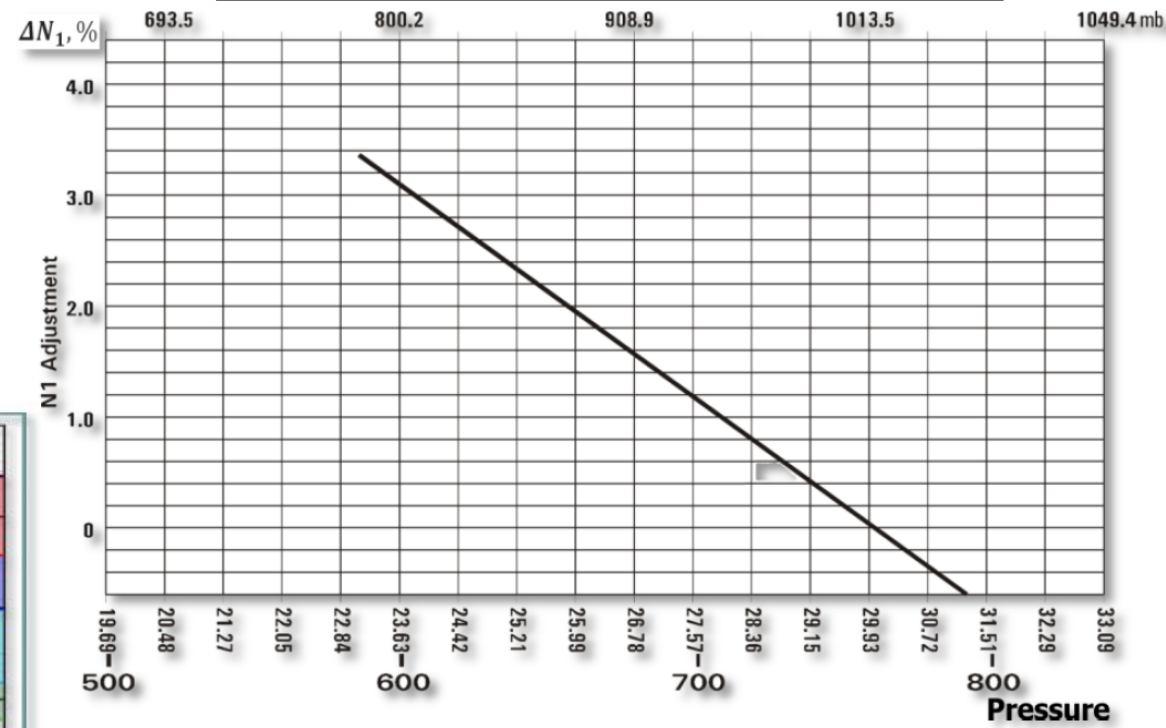

1. Maximum allowed N1 at standard atmospheric pressure
2. MAX RATED Power Area
3. TAKEOFF Power Area
4. MAX LIMITED CRUISE Power Area
5. LIMITED CRUISE Power Area
6. CRUISE Power Area

**Note:** Apply the N1 (%) established in CHART A to CHART B (N1 Adjusted for Barometric Pressure) to find the N1 for the power setting required.

*Example:* To obtain minimum N1 for 24 deg C (a), proceed vertically to the MIN Take Off power setting diagonals (b). Continue from the intersecting point to the left to obtain the Minimum N1 (97.2%, c). Maximum N1 is 99.4%.

As per CHART B, for a barometric pressure of 660 mm Hg (or 25.99 in Hg), an adjustment of 2 % N1 is required.

**POWERPLANT – ENGINE OPERATION LIMITS**

**Main Transmission Maximum Operating Limits**

Oil Pressure (kg/cm <sup>2</sup> )		Oil Temperature (dec C)	
IDLE Mode	0.5	MAX	90
Other Power Setting Mode	3.5 ± 0.5	Recommended	50 – 80
		Min Initial Oil Temperature	-15
		Min Oil Temperature Continuous Operation	+30

**Main Rotor RPM (NR) Limits**

Absolute Limits	NR (% RPM)	Maximum Time Allowed
Max Rated & Takeoff Power	103 % Max	10 sec
Max Rated & Takeoff Power	88 % Min	30 sec
All Settings Above Limited Cruise	101 % Max	20 sec
All Settings Below Limited Cruise	103 % Max	20 sec
Normal Operating Limits	NR (% RPM)	Maximum Time Allowed
Idle	55 to 70 – two engines	20 minutes
	40 to 55 – one engine	
Cruise	97 % Max	Not Limited
Limited Cruise	97 % Max	60 minutes
Max Limited Cruise	97 % Max	60 minutes
Takeoff	94 % Max	6 to 15 minutes
Max Rated Power	94 % Max	6 to 60 minutes

**Intermediate Gearbox Operating Limit**

Oil Temperature (dec C)	
All Power Settings	MAX 110

**Tail Rotor Gearbox Operating Limit**

Oil Temperature (dec C)	
All Power Settings	MAX 110



## POWERPLANT – ENGINE PROTECTION SYSTEMS

### N1 (GAS GENERATOR/COMPRESSOR) GOVERNING LOOP

During **steady-state operation**, the N1 regulator, droop compensator, engine governor and temperature limiter automatically control the fuel flow into the combustion chamber of the engine. Each element affects the fuel flow only during specific conditions:

- The N1 RPM regulator controls the fuel flow at IDLE power
- The Droop Compensator adjusts the fuel flow at operational power conditions from FLIGHT IDLE up to LIMITED TAKEOFF. This includes flat pitch descents.
- The Engine Governor system controls maximum fuel flow at LIMITED TAKEOFF and TAKEOFF power.
- The Gas Temperature (PTIT) Limiter system also controls maximum fuel flow at LIMITED TAKEOFF and TAKEOFF power.

The **Engine Governor N1 Loop** prevents compressor overspeed by reducing the fuel flow to the combustion chamber when the preset maximum RPM is reached.

The system monitors and corrects the maximum N1 limit by using inputs from:

- N1 RPM transducer mounted on the engine accessory drive
- Pressure readings from a pressure transducer mounted in the cargo cabin
- Temperature readings from the engine inlet temperature probe

The Temperature Limiter actuator (IM-3A) controls the amount of fuel reduction.



## POWERPLANT – ENGINE PROTECTION SYSTEMS

### N2 (FREE POWER TURBINE) GOVERNING LOOP

The Engine Governor N2 Loop automatically activates and shuts down the engine in the event of power turbine overspeed (118 +/- 2 % N2 RPM). The N2 loop uses the input from a pair of N2 transducers mounted in the aft support housing to determine actual N2 speed. The emergency fuel shutoff valve cuts off the fuel flow into the combustion chamber and the engine shuts down if the maximum N2 speed is reached. A power boost circuit is included in the governor system to allow maximum power for emergency takeoff with one engine.

In a **climb at maximum continuous power with a constant collective pitch angle**, the main rotor RPM is automatically maintained at 95±2% up to a limited altitude. Further climb will result in the main rotor RPM drooping as engine power output is reduced due to compressor RPM limits imposed by the engine governor system. Maintain main rotor RPM above 92% by gradually reducing collective pitch as main rotor RPM begins to droop. The maximum continuous power limitations begin to affect main rotor RPM at 1000 - 1500 m.

In a **climb at cruise power with a constant collective pitch angle**, the main rotor RPM is automatically maintained constant up to an altitude of 2000 - 2500 m.

In a **climb at takeoff power with constant collective pitch angle**, the main rotor RPM is not maintained automatically. Maintain main rotor RPM in the 92-94% range by gradually reducing collective pitch as altitude increases.

In **transitional maneuvering**, the main rotor RPM is automatically maintained at 95± 2% only within a limited rate of collective application:

- When increasing collective, no less than 5 seconds from 1 - 3° collective pitch up to the pitch angle establishing takeoff power.
- When reducing collective, no more than 1°/sec from any starting collective pitch angle

Collective input rates above these limits can lead to main rotor RPM drooping below the minimum allowable limit (88% NR) when increasing collective or overspeed the main rotor above the maximum allowable limit (103% NR) when reducing collective.

**Note: If main rotor RPM runs outside 95±2%, adjust collective to return RPM to the normal range.**





## POWERPLANT – ENGINE PROTECTION SYSTEMS

### PTIT (POWER TURBINE INLET TEMPERATURE) LIMITER

When the Power Turbine Inlet Gas Temperature (PTIT) reaches  $985\pm 5^{\circ}\text{C}$ , the temperature limiter begins to send signals to the temp limiter actuator. The RT LEFT (or RIGHT) ON caution light on the pilot's left side console begins to flash.

As the PTIT continues to increase, the signal pulse duration and the flashing speed of the caution light also increases. This results in increased fuel spillage from the throttle control chamber through the temp limiter actuator, decreasing the amount of fuel fed to the combustion chamber.

The gas temperature limits at all power settings are between  $980$  and  $990^{\circ}\text{C}$ . The fuel control includes a slide valve that blocks the actuator if the temperature limiter fails.

If the temperature limiter sends a constant false signal or a very high temperature signal to the actuator, the slide valve disengages the actuator when the N1 RPM decreases to  $85\pm 1\%$  (overtemperature protection system).

## POWERPLANT – ENGINE PROTECTION SYSTEMS

### GENERATOR FAILURE

As you start flying the Mi-8 in aggressive manoeuvres, you may find yourself hearing the dreaded "GENERATOR FAILURE" aural warning and then lose electrical power (and the autopilot in the process). This is due to an electrical protection feature that automatically disconnects generators if Main Rotor RPM drops below safety limits or exceeds maximum limits.

**If you happen to run into a GENERATOR FAILURE of your own doing, how do you fix this?**

- In case of a Main Rotor underspeed (rotor droop), lower collective to unload the rotor. The RPM will then increase again. Generators will re-engage automatically again by themselves. However, the autopilot will need to be restarted manually.
- In general, fly smoothly and avoid sudden RPM drops/rotor drooping in the first place.
- Monitor power usage carefully on the relevant gauges (i.e. EPR Gauge, NR Gauge, N1 Gauge, and PTIT Gauge) whenever flying at high altitudes in the mountains or with heavy cargo, when rotor overload and RPM drop is more likely to happen.



## POWERPLANT – ENGINE PROTECTION SYSTEMS

### SYNCHRONIZER

Since the Mi-8 uses two engines, engine power synchronizers are required to balance joint engine operation; this is performed by engine fuel controls linked by power synchronizers.

The power synchronizers measure and compare the compressor delivery pressure of both engines. The engine with the lower delivery pressure (the driven engine) receives an increase in fuel flow which increases the N1 RPM. This action also causes an increase in the N1 RPM of the engine with the higher compressor delivery pressure (the driving engine). The droop compensator of the driving engine then reduces the fuel flow and thus, the RPM of the driving engine. The power synchronizers and droop compensators of both engines counterbalance each other until the compressor delivery pressure of both engines is equal.

The power synchronizer only affects the fuel flow of the driven engine, while the rotor droop compensator affects the driving engine.

If the main rotor RPM surges above 107%, the synchronizer cutoff valve in the engine fuel control disconnects the power synchronizer of the driven engine. The driven engine drops to flight idle, while the driving engine continues to operate at maximum power.

To adjust and maintain the correct Main Rotor RPM if the power synchronizer disengages, the pilot must manually adjust the collective pitch, twist grip throttle control, or ECL.



## POWERPLANT – PZU

### PSS (PARTICLE SEPARATOR SYSTEM) / DPD (DUST PROTECTION DEVICE)

The "PZU" air inlet Particle Separator System (PSS), or Dust Protection Device (DPD), protects the engine inlet during taxi, takeoff, and landing at unprepared airstrips and in sandy/dusty environments. In addition, the system provides electrical and bleed air anti-ice heating.

The system mounts on the front of the engine, in place of the nose cone assembly. Each engine has an independent particle separator system. The system begins to operate when bleed air is supplied to the ejector by opening the flow control valve. When the system is running, suction pulls contaminated air into the **inlet duct passages (1)**. Centrifugal forces throw the dust particles toward the **aft dome surface (2)** where they are driven by the air flow through the **separator baffles (4)**. The main portion of the air, with the dust removed, passes through the duct to the **engine air inlet (3)**. The contaminated air (dust concentrate) is pulled into the **dust ejector duct (5)** and **discharged overboard (6)**.

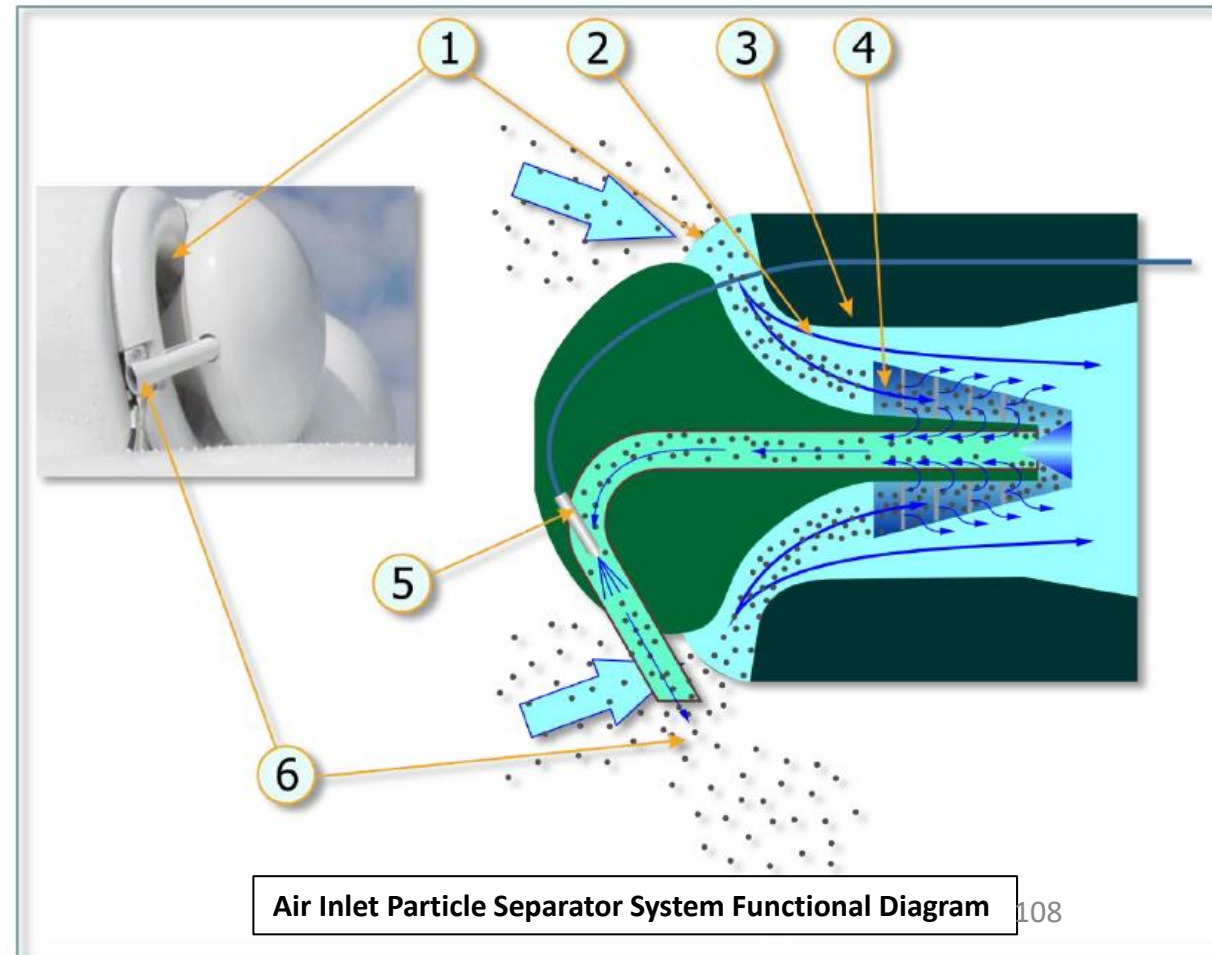

**POWERPLANT – PZU**

**PSS (PARTICLE SEPARATOR SYSTEM) / DPD (DUST PROTECTION DEVICE)**

The dust protection system can be armed by setting the ENG DUST PROT switches ON (UP). Keep in mind that the PSS consumes engine bleed air, which reduces available engine power.

Power Setting	SHAFT HORSEPOWER		RPM %		PTIT - °C		
	W/O PSS	W/ PSS	N1 - All are ± 0.5%		Nr	W/O PSS	W/ PSS
			W/O PSS	W/ PSS			
MAX RATED	2200	2100	97.7	97.7	92 - 94%	920	915
TAKEOFF	2000	1900	96.6	96.6	92 - 94%	890	885
MAX LTD CRUISE	1700	1700	95.0	95.5	93 - 97%	845	855
LTD CRUISE	1500	1500	93.9	94.4	93 - 97%	815	825
CRUISE	1200	1200	92.0	92.5	93 - 97%	770	780
IDLE	200	200			45 - 70%	780	780

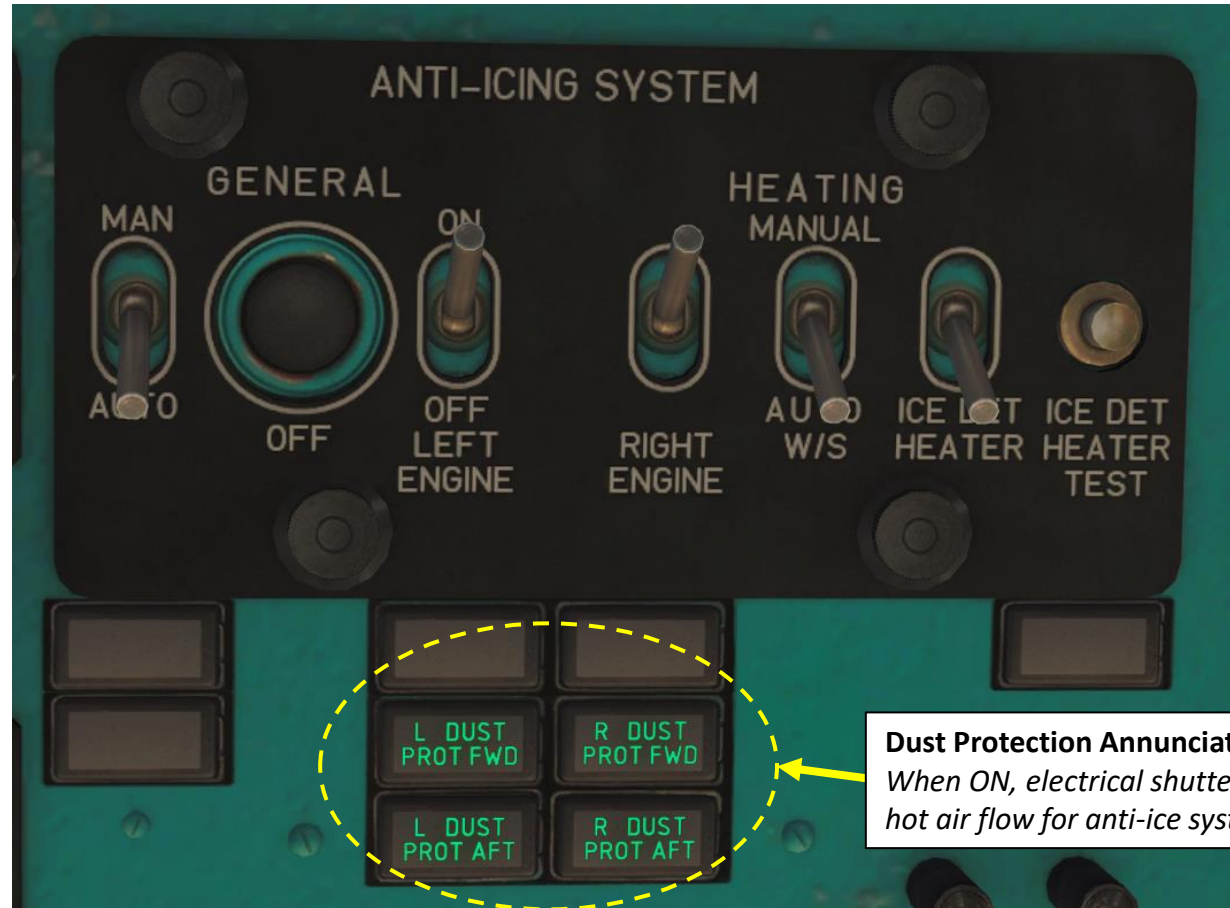

**Dust Protection Annunciators**  
When ON, electrical shutter opens hot air flow for anti-ice system needs

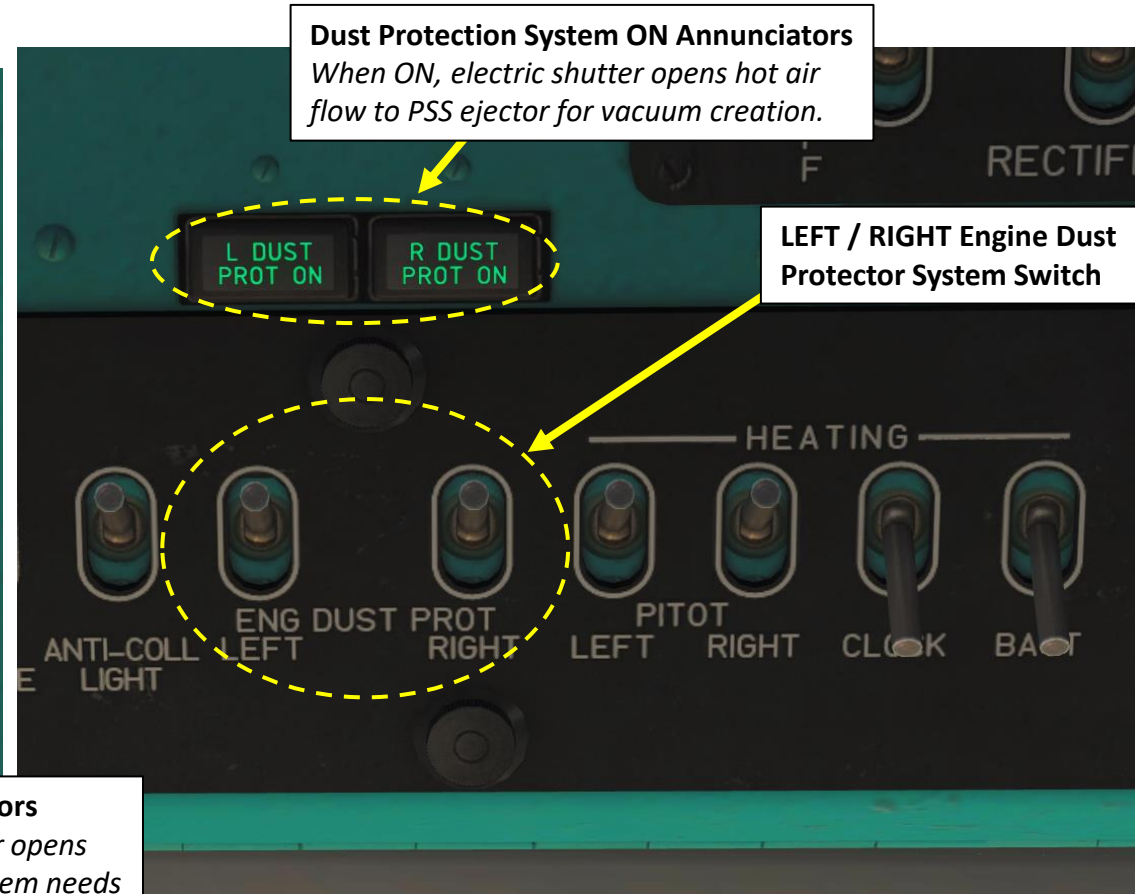

**Dust Protection System ON Annunciators**  
When ON, electric shutter opens hot air flow to PSS ejector for vacuum creation.

**LEFT / RIGHT Engine Dust Protector System Switch**



**FUEL SYSTEM**

The engine fuel system supplies and controls the fuel flow to the combustion chamber, controls the inlet and compressor variable guide vanes and air discharge valves, and shuts down the engine in the event of power turbine overspeed. The fuel components mounted on the engine include the fuel control, fuel nozzle/manifold assembly, fuel boost pump, fuel/drain valve, filters, and an emergency fuel shutoff valve. The aircraft fuel system supplies fuel to the input of the fuel boost pump. The fuel boost pump increases the fuel pressure to the required level and feeds it to the main fuel filter.

1. Service Fuel Cell
2. Right Saddle Tank
3. Left Auxiliary Tank (Not Available in DCS)
4. Left Saddle Tank

**Fuel Quantity Indicator (x100 L)**

- Outer scale: reads total fuel quantity
- Inner scale: reads fuel quantity in separate tanks

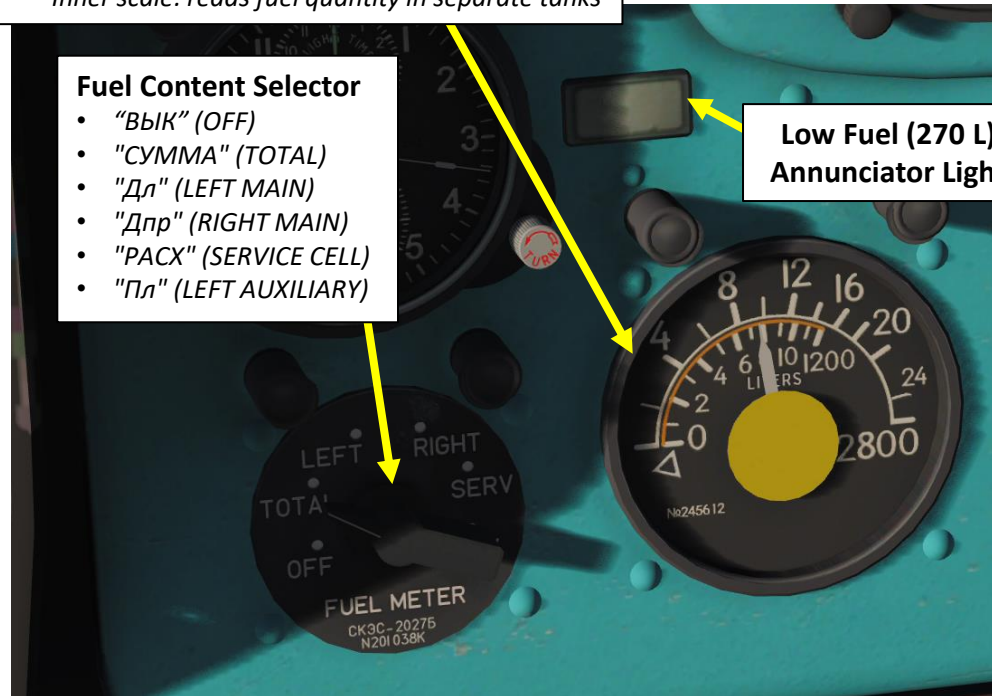

**Fuel Content Selector**

- "ВЫК" (OFF)
- "СУММА" (TOTAL)
- "Дл" (LEFT MAIN)
- "Дпр" (RIGHT MAIN)
- "РАСХ" (SERVICE CELL)
- "Пл" (LEFT AUXILIARY)

**Low Fuel (270 L) Annunciator Light**

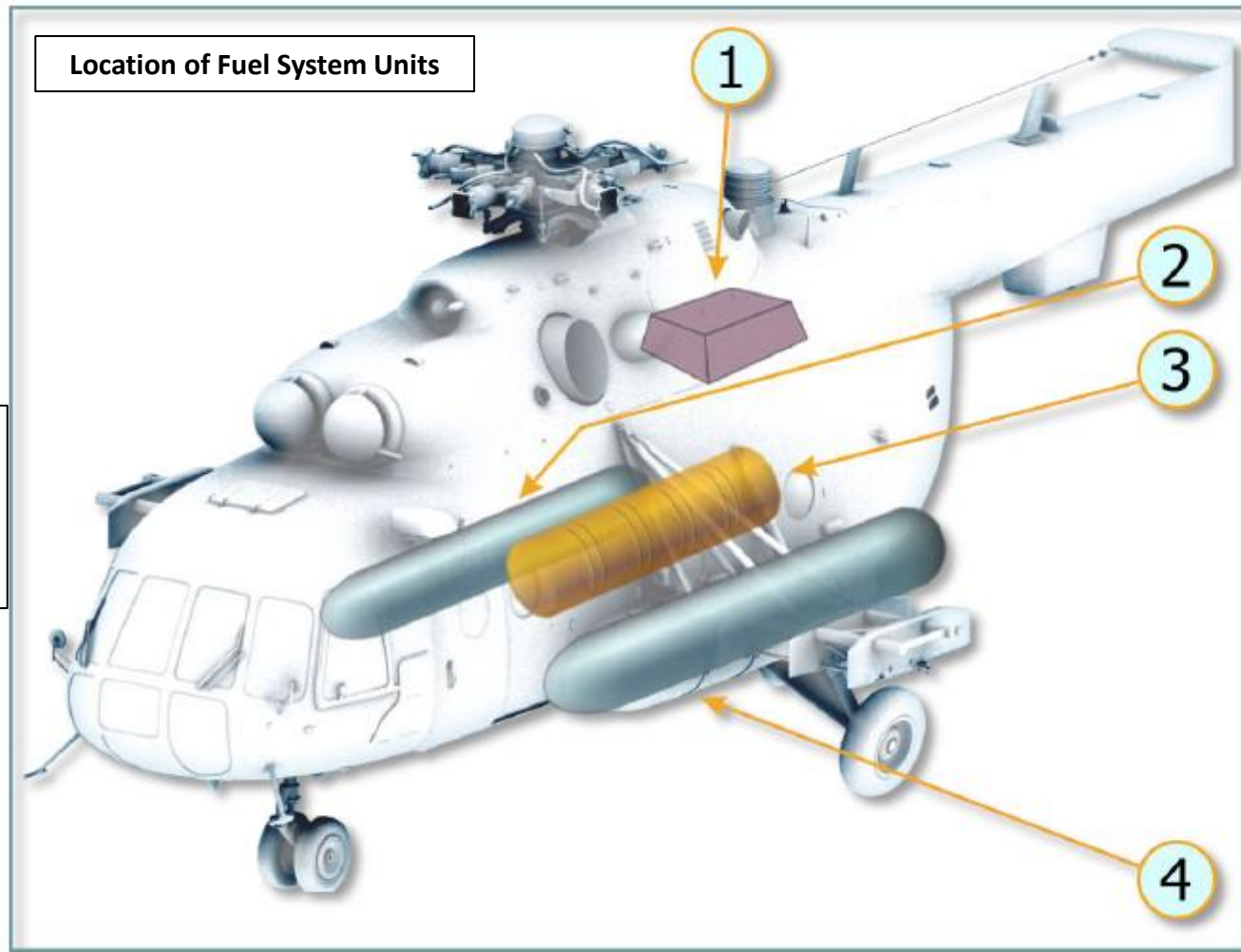

**Location of Fuel System Units**

Fuel Tank Capacity	
Service Fuel Cell	415 liters / 322 kg
Right Saddle Tank	1040 liters / 832 kg
Left Saddle Tank	1130 liters / 904 kg
Auxiliary Tank	895 liters / 694 kg (not simulated) 110



**HYDRAULIC SYSTEM**

The **Main hydraulic system** serves for feeding of combined control units (hydraulic boosters) KAY-30Б (KAU-30B, installed in longitudinal, lateral and collective pitch control systems) and PA-60Б (RA-60B, lateral control system), collective pitch control clutch dumping cylinder, variable lock cylinder (lateral control).

Hydraulic boosters can operate in two modes:

- Manual control (by pilot)
- Combined control (autopilot on)

The **Backup (Standby) hydraulic system** duplicates the main hydraulic system; it performs main system functions in case of the main system failure. The backup system is activated automatically, if main system pressure drops to  $30 \pm 5 \text{ kgf/cm}^2$ . In case of main system failure and backup system activation, the following units are deactivated automatically: autopilot АП-34Б (AP-34B), collective pitch control clutch dumping system and hydraulic lock. At that, hydraulic boosters are operated in manual mode only.

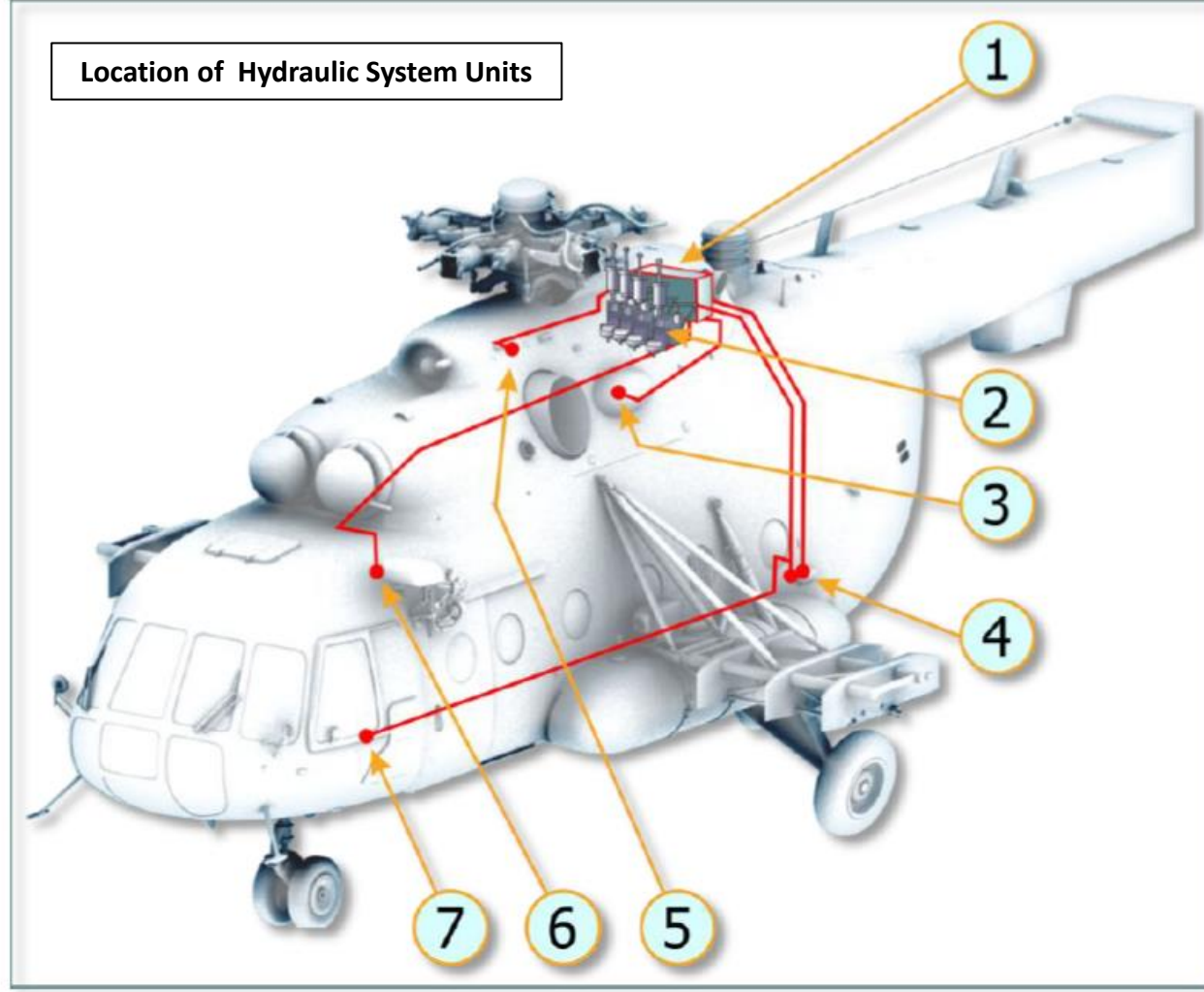

1. Hydraulic Units Panel
2. Hydraulic Boosters
3. Main System Hydraulic Pump
4. Charging Connections Panel
5. Backup System Hydraulic Pump
6. Hydraulic Lock Cylinder
7. Collective Pitch Control Clutch Dumping Cylinder





## ANTI-ICE SYSTEM

### OVERVIEW

Icing conditions have a critical impact on four main areas of a helicopter:

- Front glasses of the cockpit (loss of visibility)
- Engine Inlet (loss of power)
- Main Rotor & Tail Rotor Blades (loss of lift)
- Pitot Tubes (loss of air pressure sensors)

Flying in icing conditions requires both a robust **ice detection system** and a reliable **anti-ice system**.

1. Heated Cockpit Glasses
2. Heated parts of air intakes (including Particle Separator System and engine inlets)
3. Heated parts of Main Rotor Blades
4. Heated Parts of Tail Rotor Blades

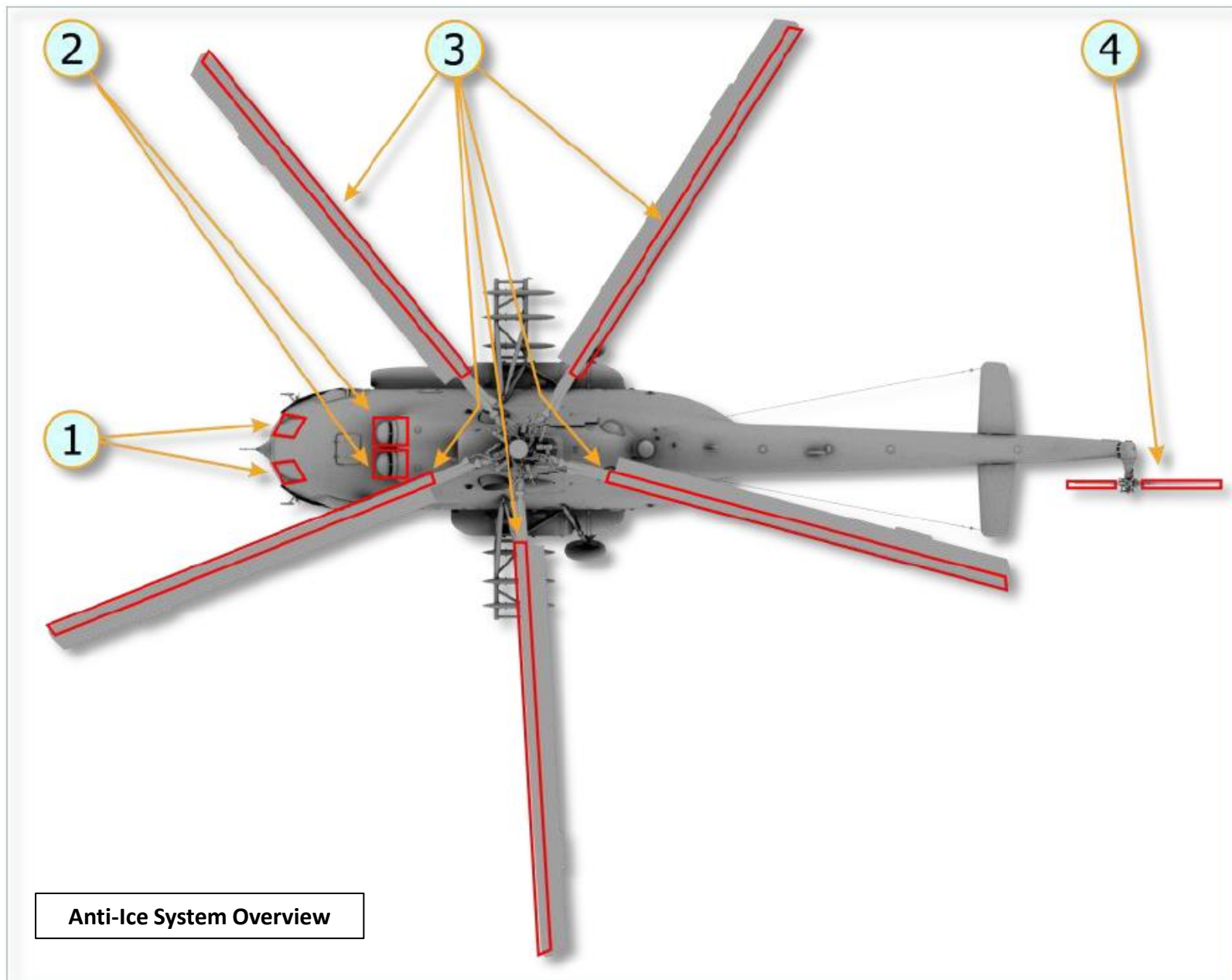



**ANTI-ICE SYSTEM**  
**ICE DETECTION**

For detection of icing, warning about helicopter structures icing and automatic energizing of anti-icing system, the Mi-8 is equipped with a radio-isotopic ice detector (RIO-3). The detecting unit of the ice detector is installed in the fan's air intake duct. Operation of the ice detector system is based on the variation in conductivity of electric circuit section, which is energized by radio-isotope beta-ray emission.

Take note that there is also a visual ice detector installed on the left sliding blister. The rod has red and black vertical stripes (5 mm wide each), which are used as a scale to evaluate the rate of icing.



## ANTI-ICE SYSTEM PARTICLE SEPARATOR SYSTEM INTEGRATION

The air inlet of the PSS (Particle Separator System) anti-icing system combines two types of anti-icing:

- Hot Bleed Air (from combustor cooling loop)
- Electrical Heating

Note: Engine inlets are heated by bleed air only.

1. Anti-Ice System of air intake (intake lip)
2. Electric shutter, opens hot air flow for anti-ice system needs
3. Temperature regulator
4. Electric shutter, opens hot air flow to PSS ejector for vacuum creation
5. Fitting for bleed air from engine combustor cooling loop
6. Heating of governor pump thermal compensator air receiver (for correct operation of governor's system)
7. Heated parts of inlet guide vane (vertical and horizontal supports)
8. Bleed air for PSS trap heating
9. PSS ejector

Diagram of Hot Air Bleed for PSS and Engines' Inlets anti-ice system and for PSS Needs

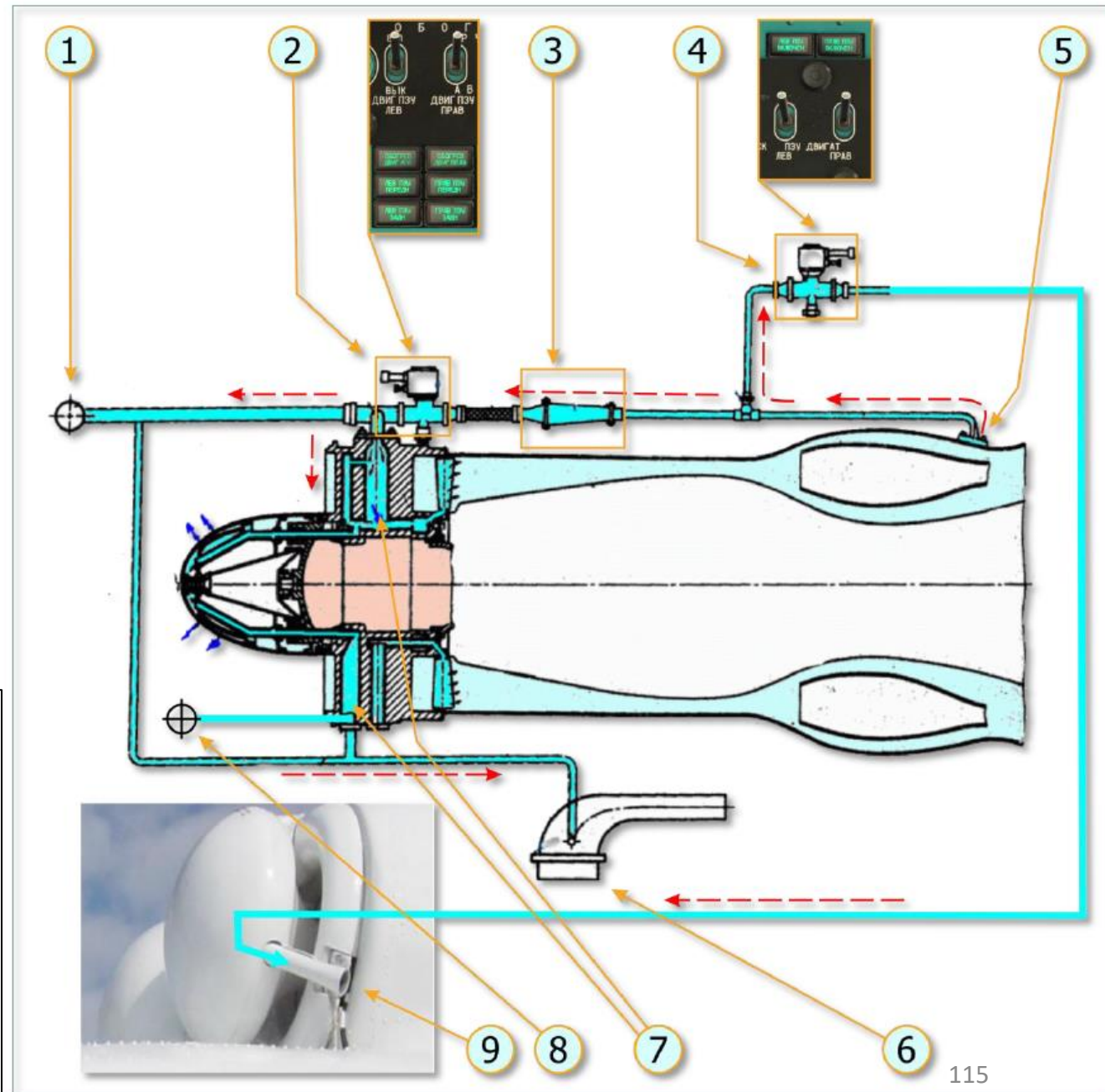



## ANTI-ICE SYSTEM BLEED AIR & ELECTRICAL HEATING COMPONENTS

Particle Separator System parts heated by hot bleed air

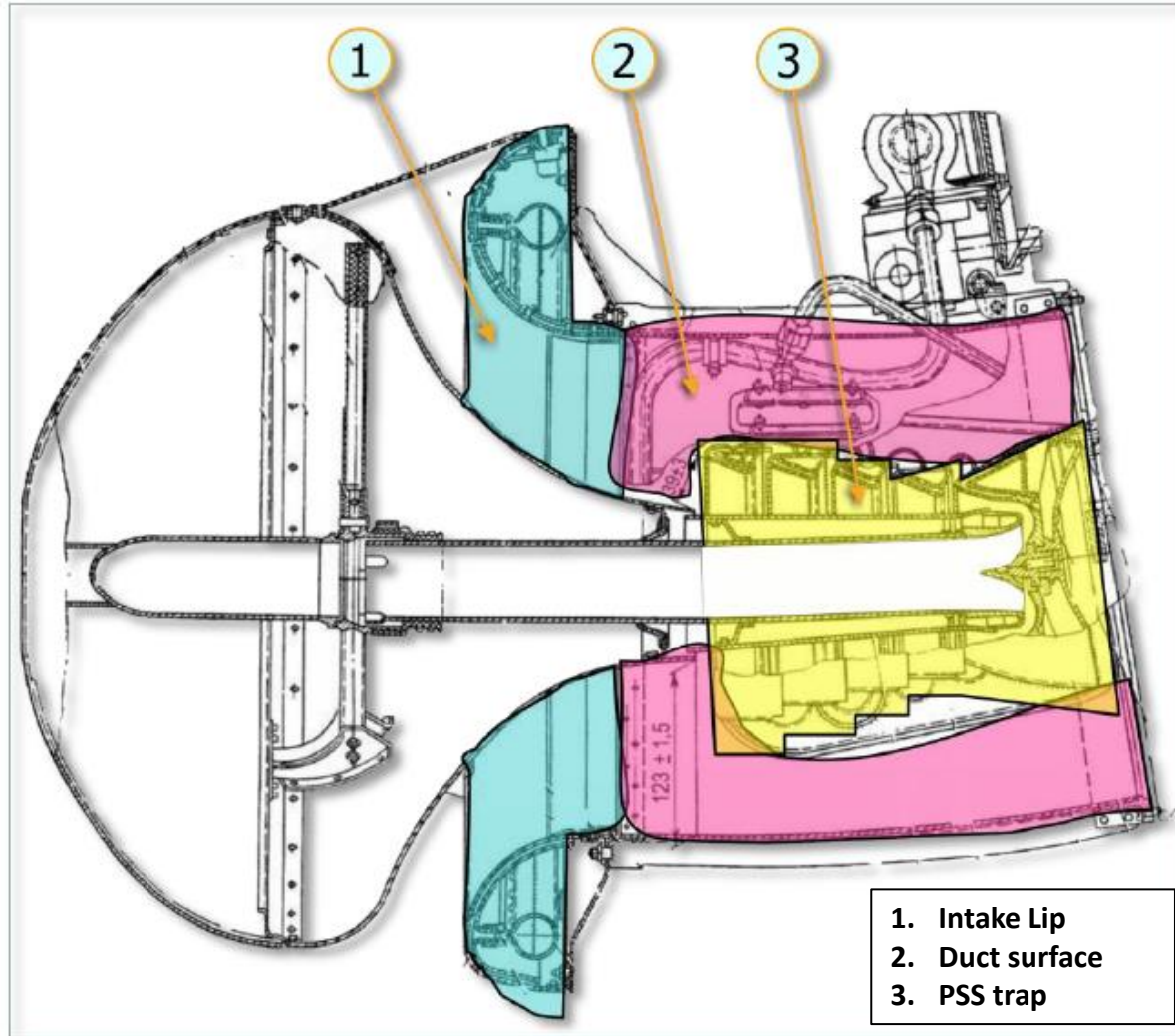

Particle Separator System parts heated by electrical heating elements

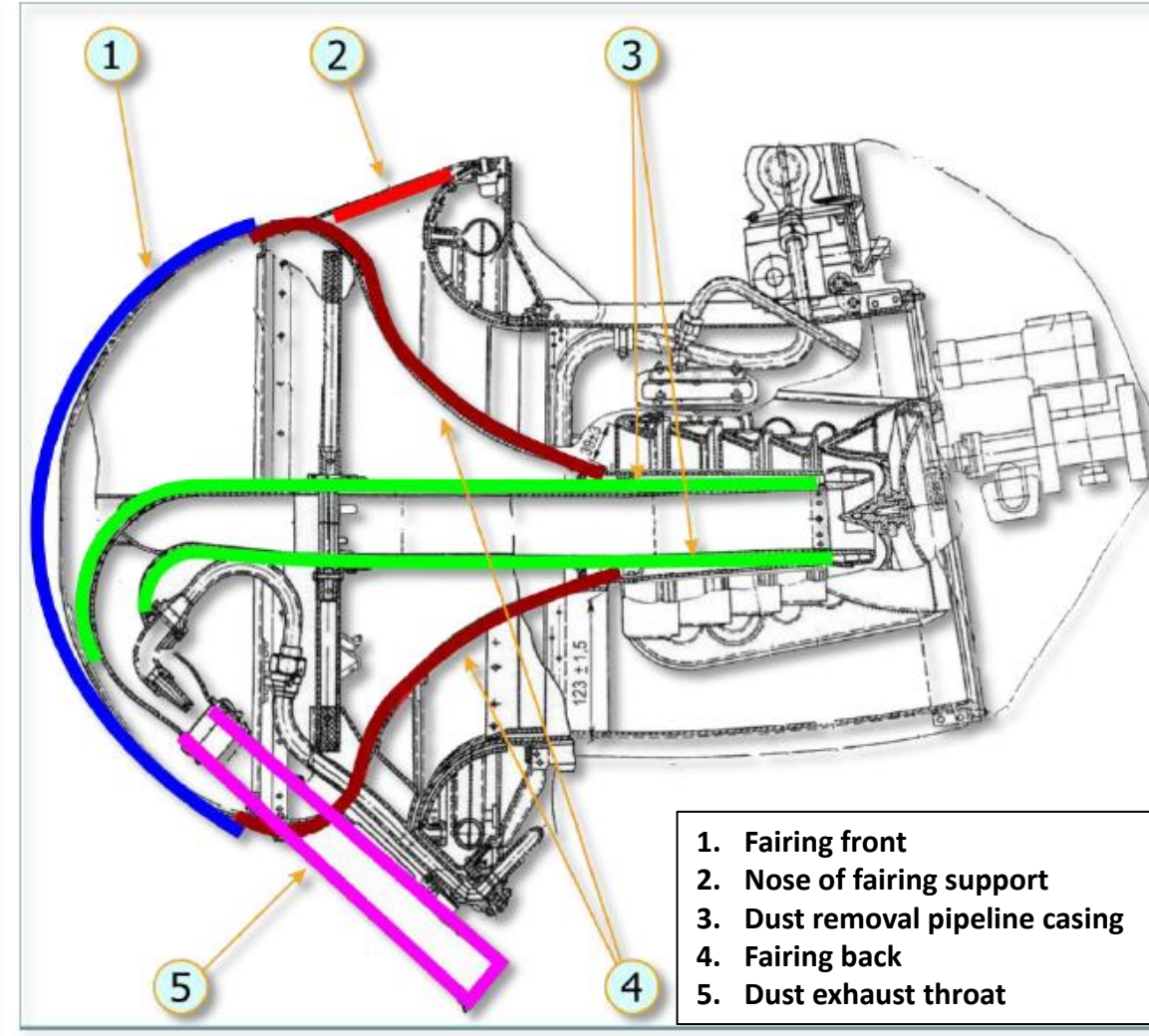

## ANTI-ICE SYSTEM

### ROTOR ANTI-ICE

Blades of the main rotor and tail rotor are heated by electrical heating elements powered by AC voltage.

- The Main Rotor heating element comprises four sections
- The Tail Rotor heating element comprises two sections

Sections are energized in cycles. In one cycle:

- The cyclic timer activates heating of every section of the main and tail rotors for 38.5 sec
- The cyclic timer activates cooling of heating elements for 115.5 sec for the main rotor section, and 38.5 for the tail rotor section.

Heating elements sections are energized in the following sequence:

- The first sections of the tail rotor blades' elements are energized along with the sections I and III of the main rotor blades' heating elements.
- The second sections of the tail rotor blades' elements are energized along with the sections II and IV of the main rotor blades' heating elements.

**Main & Tail Rotors Blades Anti-Ice System.**  
Diagram of Heating Elements Location Relative to Blade Profile

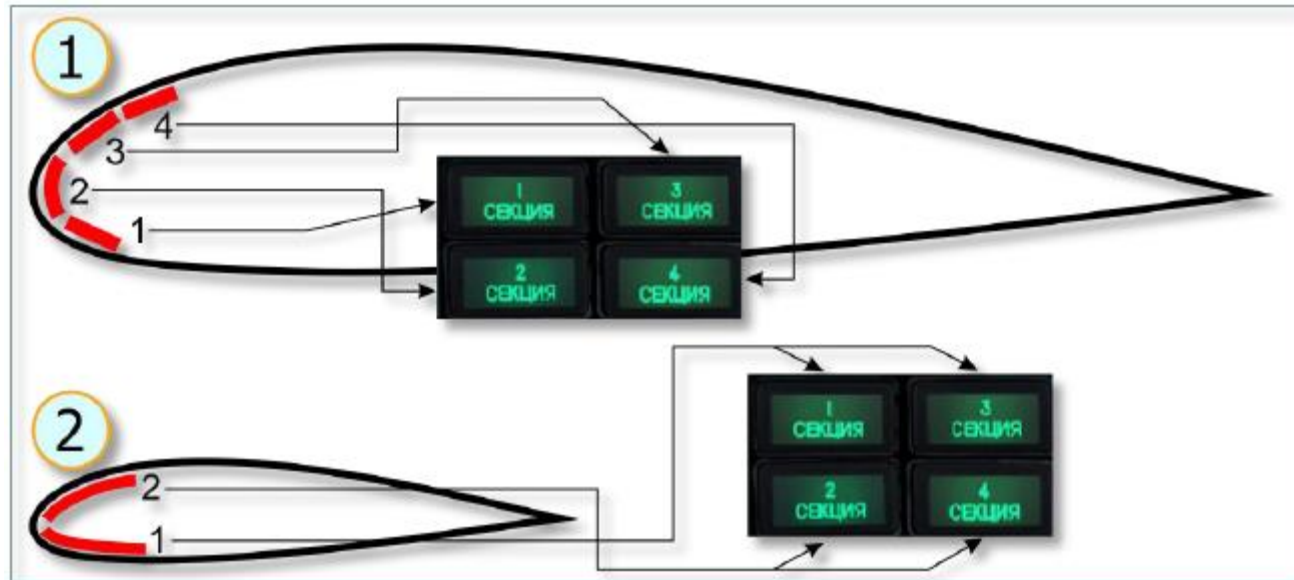

1. Diagram of Main Rotor Heating Elements (4 sections)
2. Diagram of Tail Rotor Heating Elements (2 sections)



#### Anti-Ice System Consumers Current Selector

Allows you to monitor main rotor blade heating element currents (sections 1-2-3-4-5) and tail rotor blade heating elements currents.



## FIRE PROTECTION SYSTEM OPERATION

As you fly in hostile territory, you may end up with an on-board fire. However, a fire detection, indication and extinguishing system can help you stay in the air even if a fire catches aboard the ship.

- I. Set Fire Protection System Circuit Breakers ON (UP)
  - Indication (СИГНАЛИЗАЦИЯ), First Order Operation (1 ОЧЕРЕДЬ ) and Second Order Operation (2 ОЧЕРЕДЬ) circuit breakers will power the fire detection indications and the two bottles of fire-extinguisher liquid



- II. In case of fire, a fire alarm light on the front dash will warn the crew
- III. Watch the Fire Protection System switchboard on overhead console to identify fire source and click on the First Order Fire Extinguishing System push-button for the fire source identified.
  - Image on the right shows that GREEN columns are for four different detections systems (a = LEFT engine, b = RIGHT engine, c = KO-50 kerosene-combustion heater, d = main rotor transmission, fuel tank and APU)
  - I.e. if a fire is detected in the left engine (red caution light in first column), push the First Order Ex. Button on the first column, first row of buttons to empty the first FIRE EX bottle.
  - When fire is extinguished, the LEFT ENGINE FIRE (ПОЖАР ЛЕВ ДВ) caution should come off within 10 s but the 1 ORDER (1 ОЧЕРЕДЬ) caution should remain on. To set these cautions OFF, you can use the ALARM SILENCE push-button (ВЫК. СИГНАЛИЗАЦИИ ПОЖАРА)

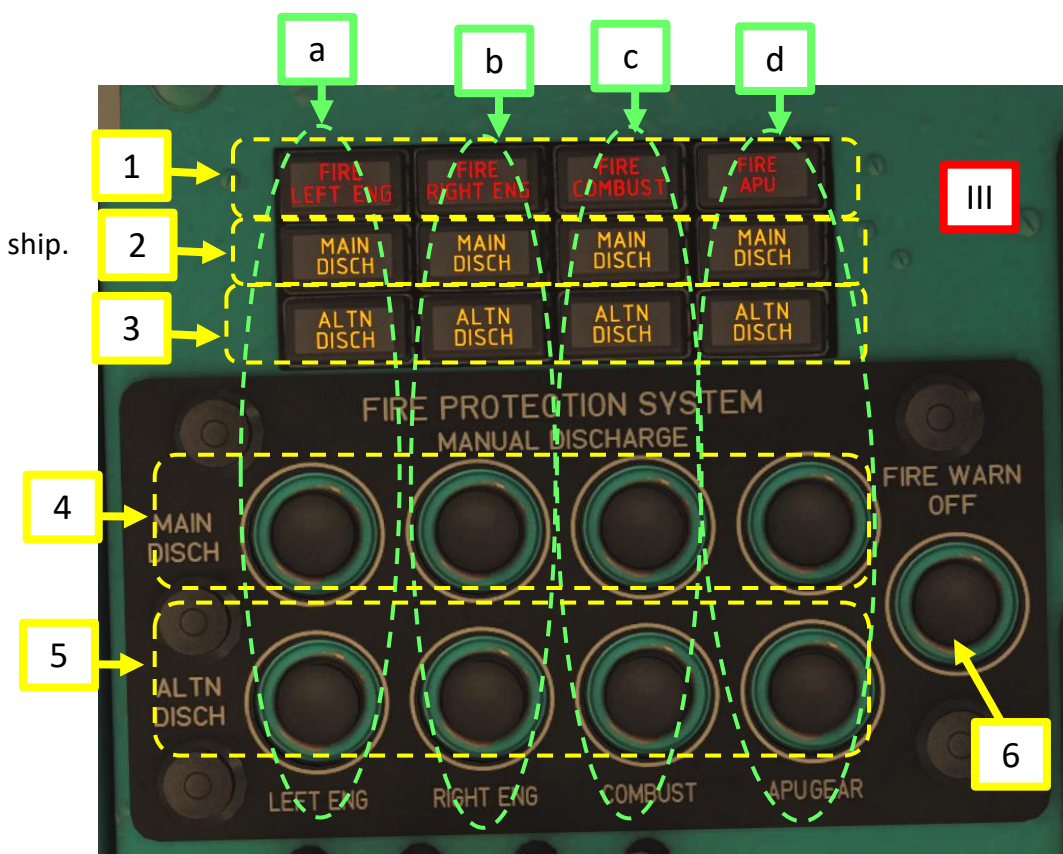

1. Lamp indicating FIRE in the protected units (LEFT ENGINE FIRE, RIGHT ENGINE FIRE, KO-50 FIRE, MAIN ROTOR/FUEL CONSUMED TANK/APU FIRE)
2. Lamp indicating operation of the first order fire extinguishing system
3. Lamp indicating operation of the second order fire extinguishing system
4. First order fire extinguishing system pushbutton
5. Second order fire extinguishing system pushbutton
6. Alarm Silence pushbutton

Letters mark lamps indicating fire, operation of fire extinguishing system ballons and pushbuttons of units fire protection system as following:

- A – LEFT ENGINE
- B – RIGHT ENGINE
- C – KO-50 Kerosene Combustion Heater
- D – MAIN ROTOR transmission, fuel consumed tank and APU

## FIRE PROTECTION SYSTEM INDICATION AND ALARM SYSTEM CHECK

The procedure explained in the last page is **very, very much simplified**. For the full procedure, please consult the *“7.6 FIRE PROTECTION SYSTEM”* section in *Belsimtek’s manual*. The previous tutorial assumes that everything is functioning as expected, but real life is not so perfect. Before each flight, you need to monitor the serviceability of the fire protection and detection systems (whether they work or not). This is why we have a “Signal Devices Monitoring” panel on the center overhead console.

- The monitoring system is operated by battery bus via the “Fire Protection System Indication” circuit breaker (ПРОТИВОПОЖАРНАЯ СИСТЕМА СИГНАЛИЗАЦ) and the “Signal Devices Monitoring” (КОНТРОЛЬ ДАТЧИКОВ) rotary switch (5). Signal devices are integrated into six monitoring channels, and each of them is connected to its switch contact. For monitoring, each switch is required to set the checking channels position alternately. Signal devices serviceability is shown if the appropriate “Indicating Fire” lamp (3) is illuminated.
- Division of the groups of different units signal devices for monitoring channels is given in the table below:

Monitored Units	Monitoring Channels						Lamps ON
	I	II	III	IV	V	VI	
Left Engine	x	x	x				LEFT ENGINE FIRE ПОЖАР ЛЕВ. ДВ.
Right Engine	x	x	x				RIGHT ENGINE FIRE ПОЖАР ПРАВ ДВ.
Main Rotor Transmission and Service Fuel Cell	x	x	x	x			MAIN ROTOR AI-9 FIRE ПОЖАР РЕДУК. АИ-9
AI-9V (AI-9B) Engine					x	x	KO-50 FIRE ПОЖАР РЕДУК. АИ-9
KO-50 Kerosene-combustion Heater	x	x					KO-50 FIRE ПОЖАР КО-50

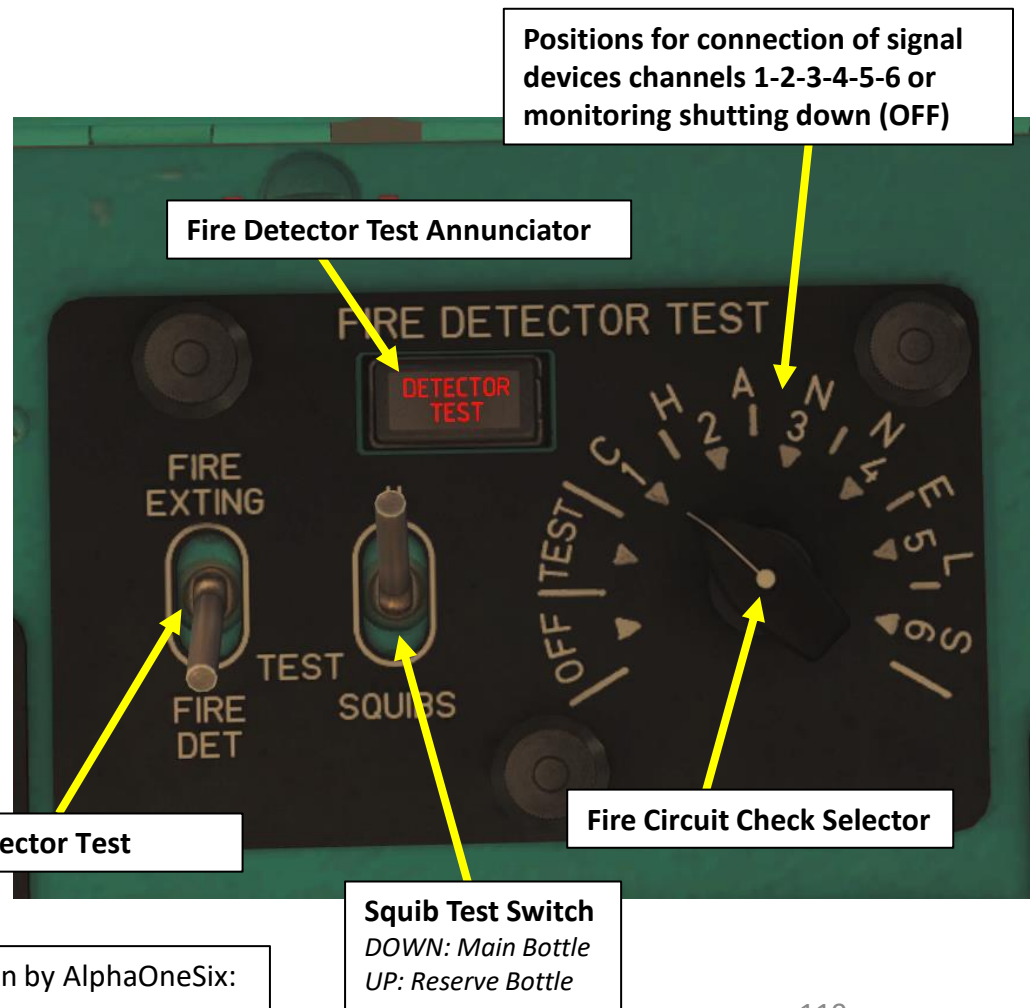

For a more thorough explanation on the fire protection system, please consult this presentation by AlphaOneSix:  
LINK: <https://drive.google.com/file/d/0B-uSpZROuEd3cXJOMU9wS1FOWTA/view?usp=sharing>

**Squib Test Switch**  
DOWN: Main Bottle  
UP: Reserve Bottle



**KO-50 KEROSENE COMBUSTION HEATER SYSTEM**

The KO-50 Kerosene Combustion Heater system is mainly used to heat the cabin and cockpit.

The heater operates in the following way: after heater is started, in the combustion chamber the kerosene-air mixture is being burned and exhaust gas is being removed through the exhaust nozzle. Heat from the combustion warms up the calorifer. The airflow from a fan moves through calorifer, air warms up in the process and us then fed to the helicopter’s cockpit.

The heater can operate either in automatic, manual or ventilation mode.

- When heater is operating in automatic mode, the temperature, set by the temperature knob, is being maintained constant.
- Manual control is used for maximum or medium heating output modes. The recirculation mode is used to speed up the heating of the cabins during winter conditions by using air from the cargo cabin.

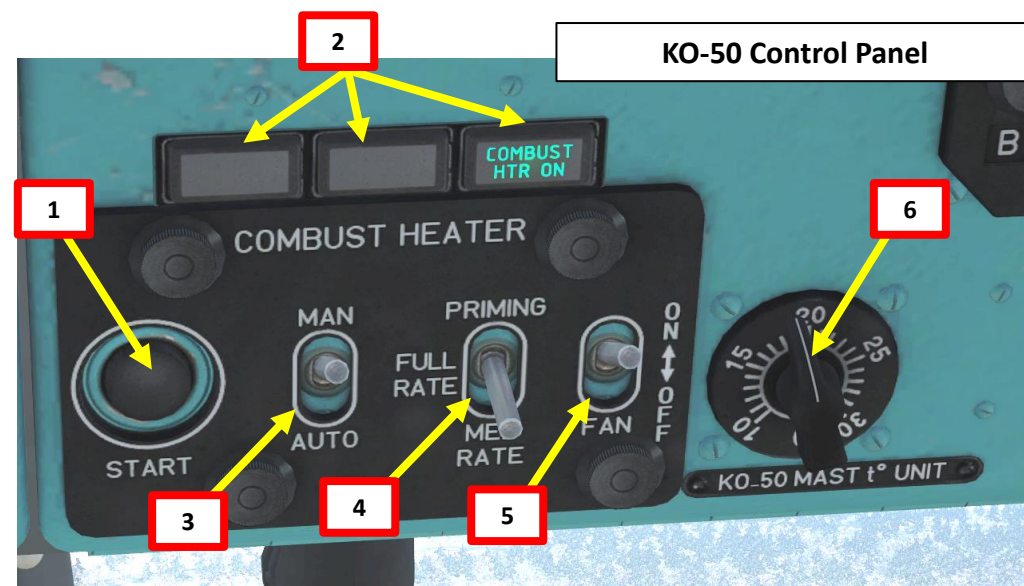
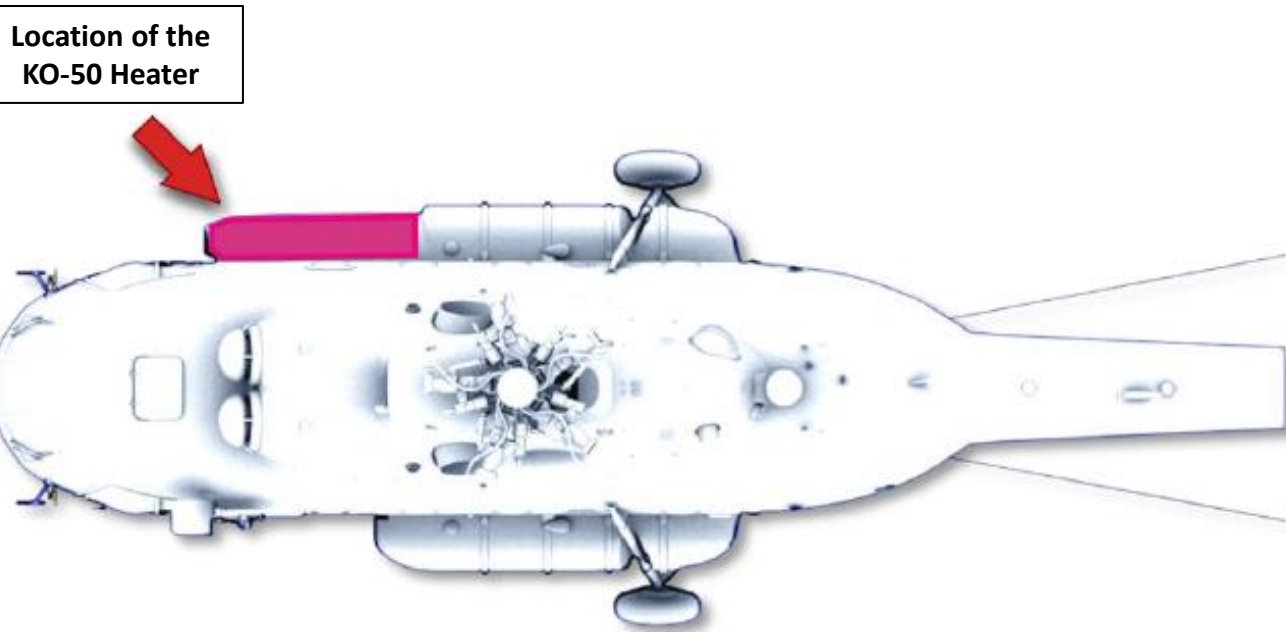

- 1. KO-50 Start Button**
- 2. KO-50 Status Panel**
  - PREHEATER indicates engagement of the fuel preheater
  - IGNITION indicates operation of the igniter
  - COMBUST HTR ON: KO-50 is operating
- 3. KO-50 Modes Switch**
  - MANUAL
  - NEUTRAL
  - AUTO
- 4. PRIME-HIGH-MEDIUM Output Mode Selector**
  - HIGH and MEDIUM heat output modes
  - PRIME is used for system maintenance (not simulated)
- 5. Fan Switch**
- 6. Temperature Control Knob**

# FORCES: TORQUE, TRANSLATIONAL & VERTICAL LIFT

## IN A NUTSHELL...

In a hover, you will most likely generate vertical lift only since the lift vector is pointing upwards. However, if you push your nose down and gain horizontal speed, you will notice that you will generate much more lift as you gain speed. This is called "Translational Lift": your blades gain much more lift efficiency as you accelerate.

You might also wonder why you need to apply right pedal when you are hovering. This is simply to counter the torque created by the main rotor blades' rotation in the yaw axis. In a prop airplane, the torque will force you to use pedal on takeoff to stay straight. The same principle applies for a helicopter, but in a different axis.

Translating tendency is a left lateral movement of the helicopter that is a combination of tail rotor thrust and main rotor torque; translating tendency is countered with right cyclic.

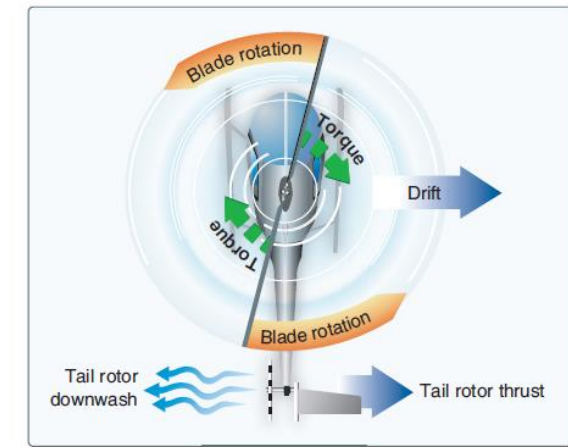

A tail rotor is designed to produce thrust in a direction opposite torque. The thrust produced by the tail rotor is sufficient to move the helicopter laterally.

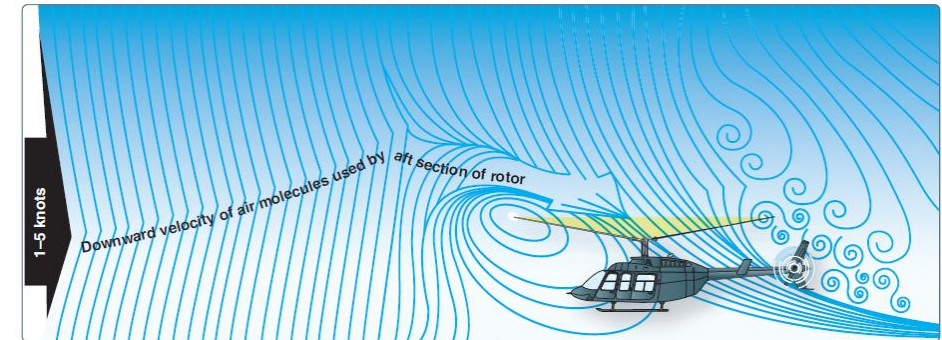
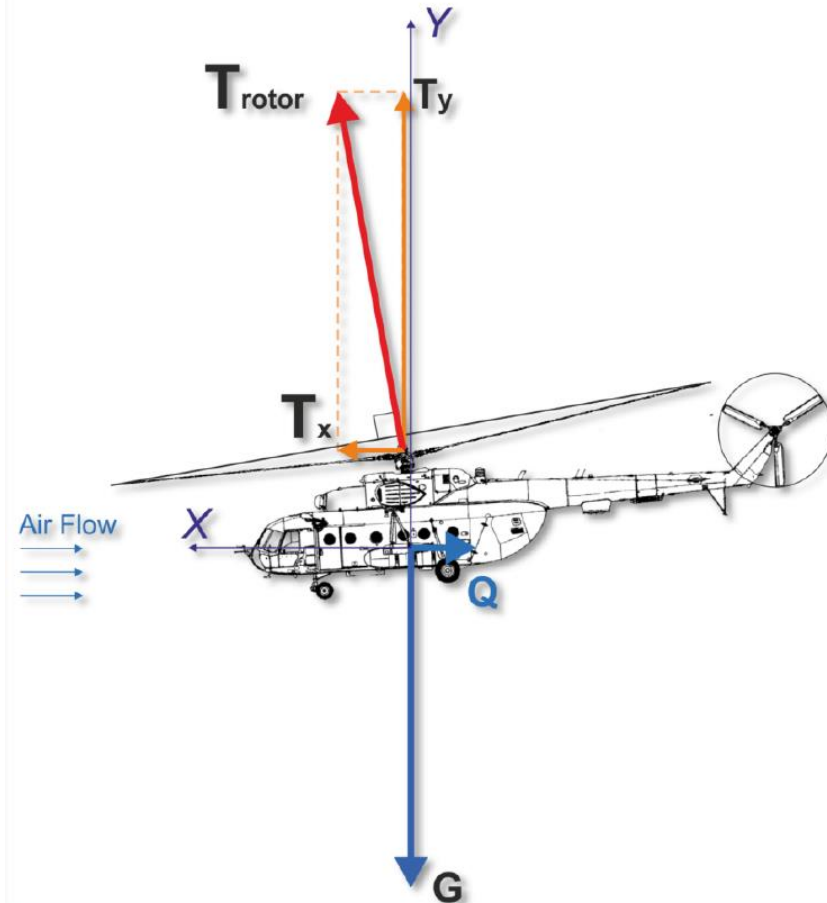

The airflow pattern for 1-5 knots of forward airspeed. Note how the downwind vortex is beginning to dissipate and induced flow down through the rear of the rotor system is more horizontal.

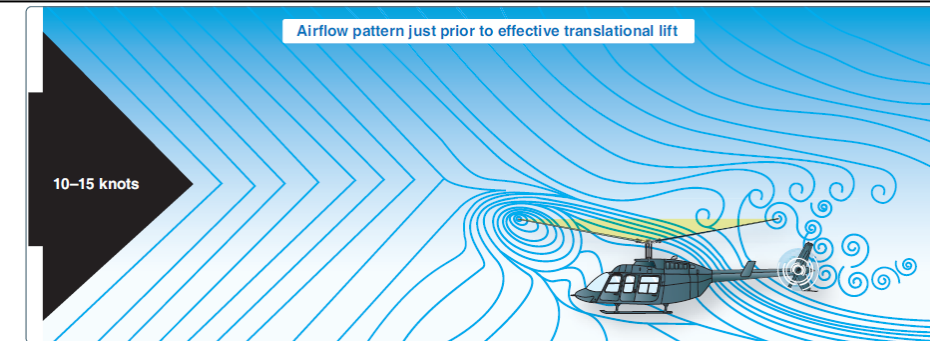

The airflow pattern for 10-15 knots. At this increased airspeed, the airflow continues to become more horizontal. The leading edge of the downwash pattern is being overrun and is well back under the nose of the helicopter.



## GYROSCOPIC PRECESSION

### IN A NUTSHELL...

The spinning main rotor of a helicopter acts like a gyroscope. What we call “**gyroscopic precession**” is the resultant action or deflection of a spinning object when a force is applied to this object. This action occurs 90 degrees in the direction of rotation from the point where the force is applied, like on a rotating blade.

Now, what does this mean and why should you care about such mumbo jumbo? This means that if you want to push your nose down, you push your cyclic forward. What happens in reality is that pilot control input is mechanically offset 90 degrees “later”, as shown on the pictures below.

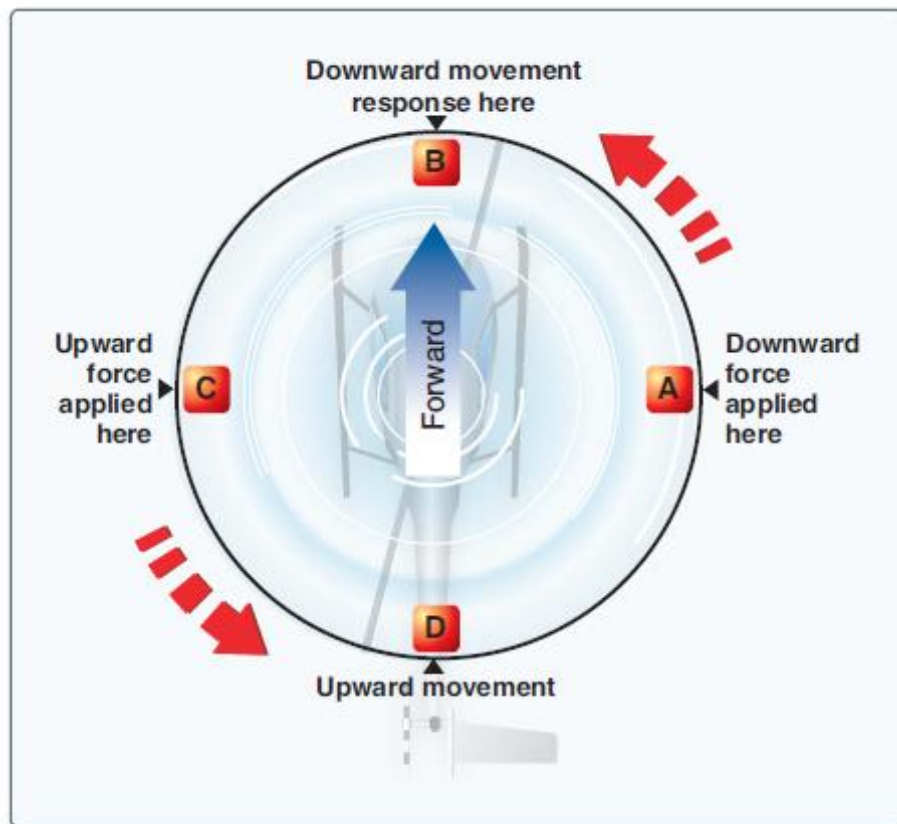

Figure 2-28. Gyroscopic precession.

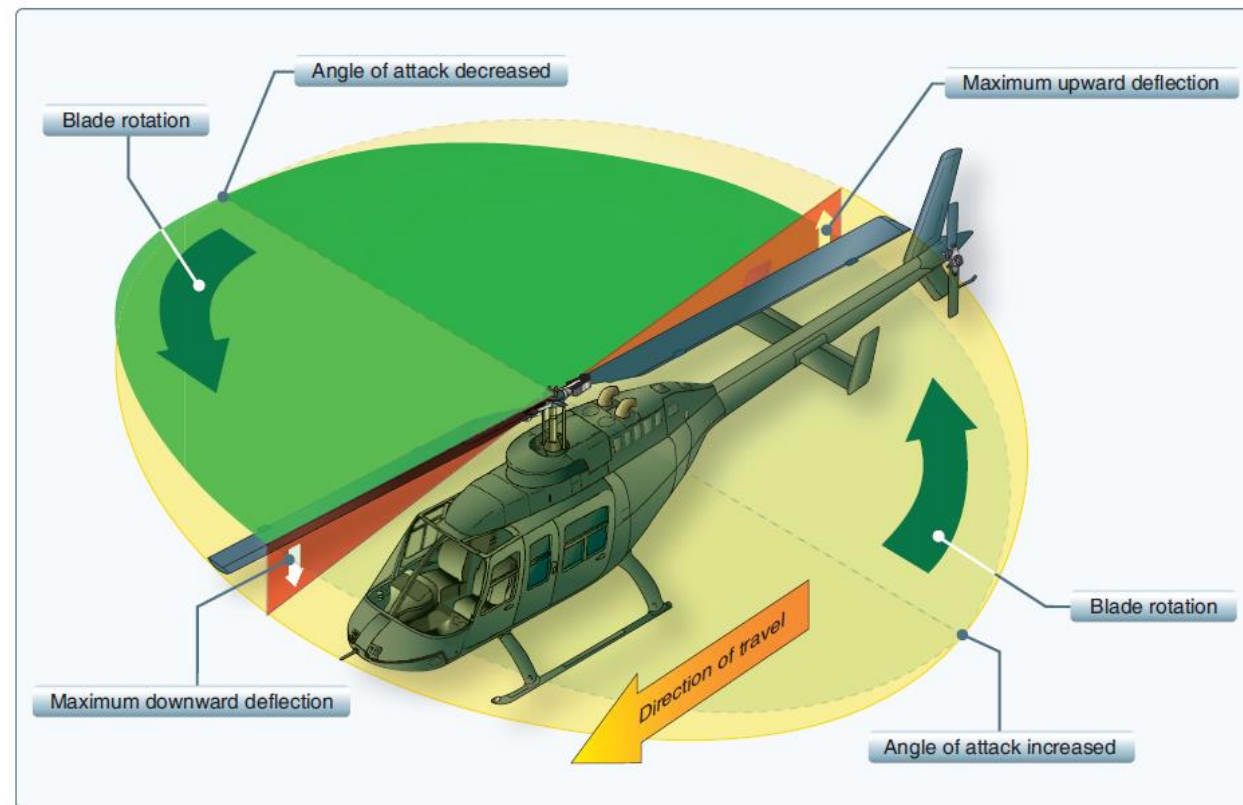

Figure 2-29. As each blade passes the 90° position on the left in a counterclockwise main rotor blade rotation, the maximum increase in angle of incidence occurs. As each blade passes the 90° position to the right, the maximum decrease in angle of incidence occurs. Maximum deflection takes place 90° later—maximum upward deflection at the rear and maximum downward deflection at the front—and the tip-path plane tips forward.

## RETREATING BLADE STALL & DISSYMMETRY OF LIFT

In forward flight, the relative airflow through the main rotor disk is different on the advancing and retreating side. The relative airflow over the advancing side is higher due to the forward speed of the helicopter, while the relative airflow on the retreating side is lower. This dissymmetry of lift increases as forward speed increases. To generate the same amount of lift across the rotor disk, the advancing blade flaps up while the retreating blade flaps down. This causes the AOA to decrease on the advancing blade, which reduces lift, and increase on the retreating blade, which increases lift.

At some point as the forward speed increases, the low blade speed on the retreating blade, and its high AOA cause a stall and loss of lift. Retreating blade stall is a major factor in limiting a helicopter's never-exceed speed (VNE) and its development can be felt by a low frequency vibration, pitching up of the nose, and a roll in the direction of the retreating blade. High weight, low rotor rpm, high density altitude, turbulence and/or steep, abrupt turns are all conducive to retreating blade stall at high forward airspeeds. As altitude is increased, higher blade angles are required to maintain lift at a given airspeed.

Thus, retreating blade stall is encountered at a lower forward airspeed at altitude. Most manufacturers publish charts and graphs showing a VNE decrease with altitude.

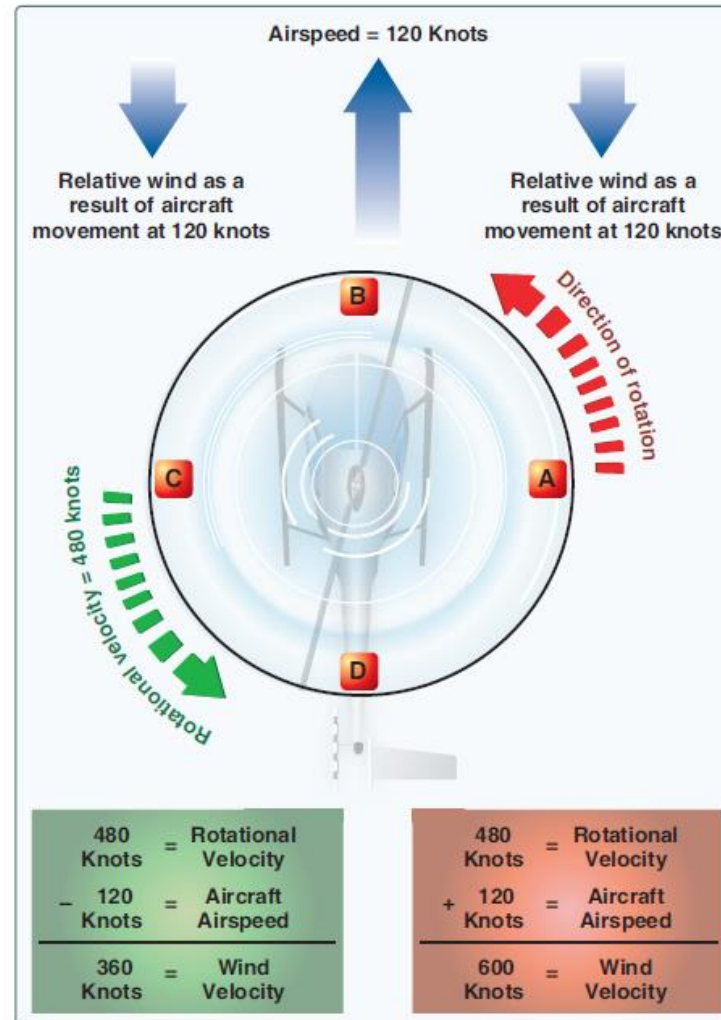
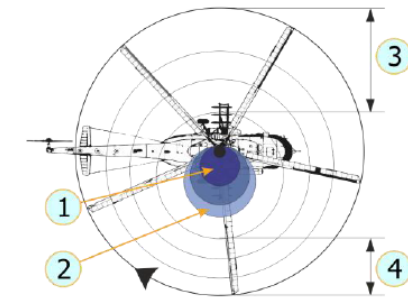

Figure 2-33. Airflow in forward flight.

### IN A NUTSHELL...

Did you ever wonder why your helicopter can never stay straight when you center your cyclic stick? The reason why you always need to hold your stick to your left and towards you is because the lift generated by your rotor blade is not equal everywhere on your blades. Therefore, the lift profile is **not symmetric**. "Lift dissymmetry" is just other fancy ways to refer to this phenomenon.

"Retreating Blade Stall" is a major factor in limiting a helicopter's maximum forward airspeed. Just as the stall of a fixed wing aircraft wing limits the low-air-speed flight envelope, the stall of a rotor blade limits the high-speed potential of a helicopter.



1 – reverse airflow area; 2 – no lift area; 3 – lift produced in this area requires low blade angle of attack; 4 – lift produced in this area requires greater blade angle of attack (lift must equal that of zone 3).

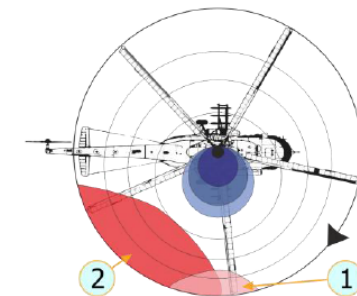

1 – area of blade tip stall, causes vibration and buffeting; 2 – if blade angle of attack continues to remain high, stall area increases. The helicopter pitches up and rolls right (stalling).



## OGE VS IGE: UNDERSTANDING GROUND EFFECT

Ground effect is the increased efficiency of the rotor system caused by interference of the airflow when near the ground. The air pressure or density is increased, which acts to decrease the downward velocity of air. Ground effect permits relative wind to be more horizontal, lift vector to be more vertical, and induced drag to be reduced. These conditions allow the rotor system to be more efficient.

Maximum ground effect is achieved when hovering over smooth hard surfaces. When hovering over surfaces as tall grass, trees, bushes, rough terrain, and water, maximum ground effect is reduced. Rotor efficiency is increased by ground effect to a height of about one rotor diameter (measured from the ground to the rotor disk) for most helicopters. Since the induced flow velocities are decreased, the AOA is increased, which requires a reduced blade pitch angle and a reduction in induced drag. This reduces the power required to hover IGE.

The benefit of placing the helicopter near the ground is lost above IGE altitude, which is what we call OGE: Out of Ground Effect.

### **IN A NUTSHELL...**

Ground Effect is what gives you additional lift when you are flying close to the ground. A hover, for instance, is much easier to maintain close to the ground torque-wise since ground effect is nullified at higher altitudes.

Ground effect is specially important on missions where you need to fly NOE (Nap-Of-Earth, where even lawnmowers dare not set foot).

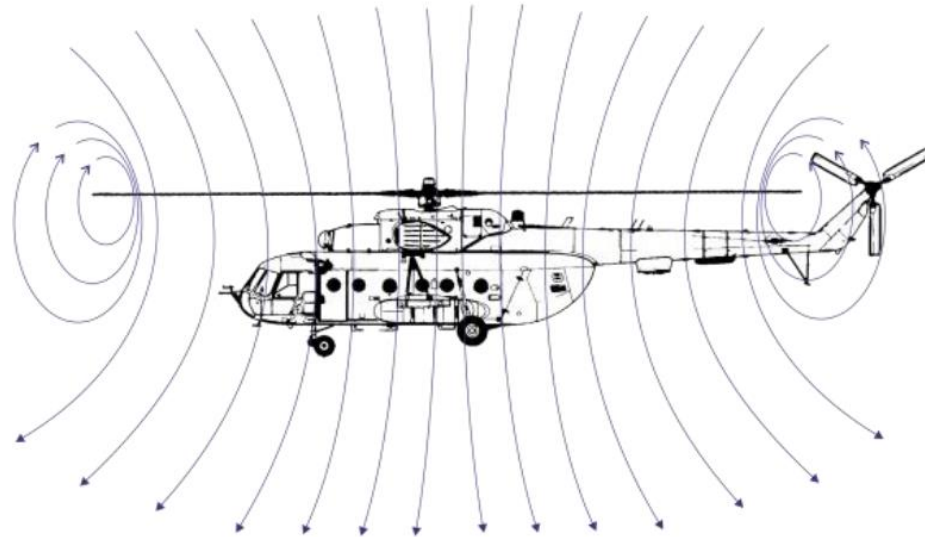

Fig. 9.16. Airflow when out of ground effect



Fig. 9.17. Airflow when in ground effect

## VORTEX RING STATE (VRS)

Vortex ring state describes an aerodynamic condition in which a helicopter may be in a vertical descent with 20 percent up to maximum power applied, and little or no climb performance. The term “settling with power” comes from the fact that the helicopter keeps settling even though full engine power is applied.

In a normal out-of-ground-effect (OGE) hover, the helicopter is able to remain stationary by propelling a large mass of air down through the main rotor. Some of the air is recirculated near the tips of the blades, curling up from the bottom of the rotor system and rejoining the air entering the rotor from the top. This phenomenon is common to all airfoils and is known as tip vortices. Tip vortices generate drag and degrade airfoil efficiency. As long as the tip vortices are small, their only effect is a small loss in rotor efficiency. However, when the helicopter begins to descend vertically, it settles into its own downwash, which greatly enlarges the tip vortices. In this vortex ring state, most of the power developed by the engine is wasted in circulating the air in a doughnut pattern around the rotor.

A fully developed vortex ring state is characterized by an unstable condition in which the helicopter experiences uncommanded pitch and roll oscillations, has little or no collective authority, and achieves a descent rate that may approach 6,000 feet per minute (fpm) if allowed to develop.

## WHY SHOULD YOU CARE?

One of the biggest issues new pilots have is that they do not understand what VRS is, what it does, why it happens and how to counter it. In simple terms, if your airspeed is around 40 km/h (which is the speed at which VRS usually occurs), you will experience a sudden loss of lift that will cause you to drop like a rock. VRS also occurs in situations where you have a descent rate of 4 m/s or greater. More often than not, VRS happens when you are trapped in a column of disrupted air created by your own rotor blades, and this (unfortunately) often occurs at the most critical part of flight: on LANDING.

Oh, now I’ve got your attention? Good. One of the biggest problems Peter Pilots experience is to land their chopper. Even in real life, there are many pilots who do what we call a “hard landing” because they did not anticipate correctly the sudden loss of lift caused by VRS. A hard landing is when you impact the ground at a vertical speed that is too great, which causes structural damage to the landing gear, and possibly other structural components. The helicopter is not a total loss, but it will require extensive inspection and repairs, which costs time, money, and temporarily deprives the operator from one of its main sources of income.

Countering VRS is easy if you pay attention to your airspeed and descent rate. Once you enter VRS, raising the collective (which is instinctively what someone would do) will do nothing at best, or aggravate the situation at worst. To reduce the descent rate, you need to get out of that column of disrupted air. You counter VRS by pointing the nose down (or in any direction) to pick up some speed and get away from these nasty vortices.

Note: Many pilots confuse VRS with the inertia of your machine. If you come in too fast and raise your collective too slowly, it is to be expected that you will crash.



Vortex Ring State



VRS: VERIFY DESCENT RATE & SPEED



# AUTOROTATION

Autorotation is a flight state where your engine is disengaged from the rotor system and rotor blades are driven solely by the upward flow of air through the rotor. It can be caused by engine malfunction or engine failure, tail rotor failure or a sudden loss of tail rotor effectiveness.

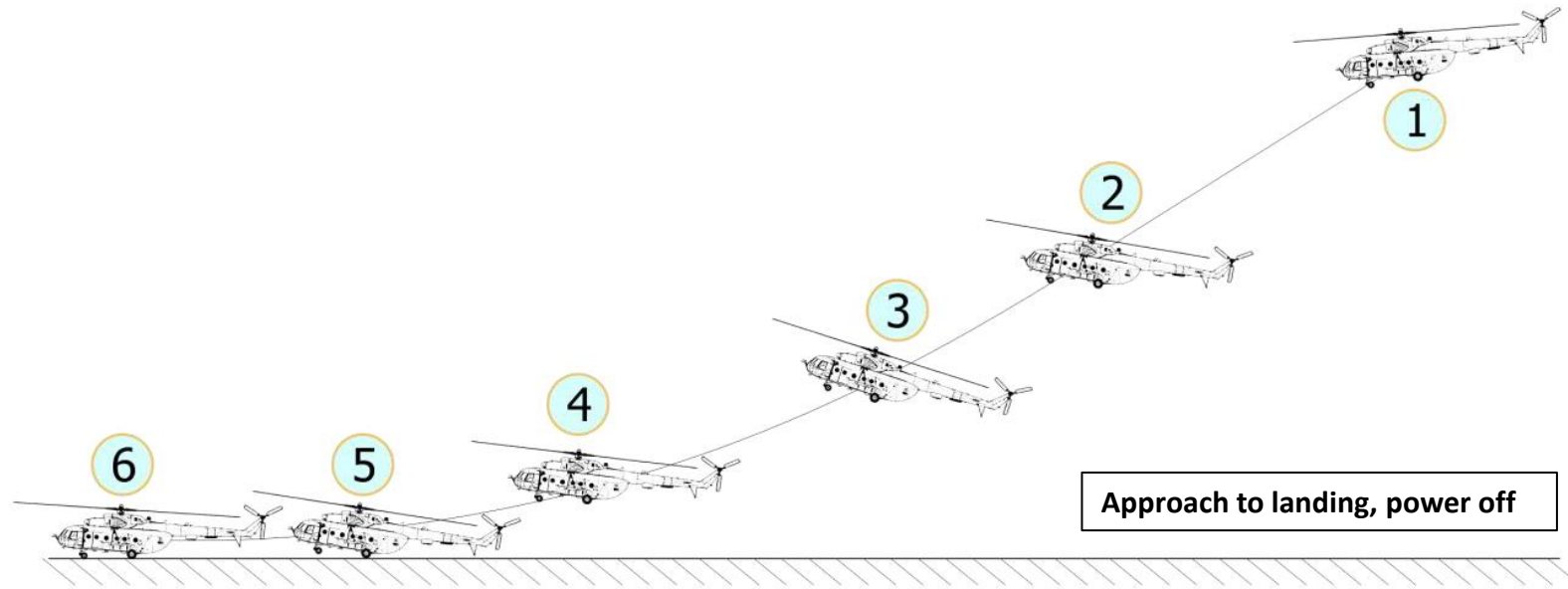

Approach to landing, power off

1. While descending, establish 70-80 km/h IAS, lower collective to maintain safe rotor RPM (collective fully down)
2. At 35-50 m altitude, increase pitch to 10 degrees above horizon
3. At 20-30 m altitude, raise collective to reduce rate of descent. This requires precise control and timing.
4. At 4-6 m altitude, set landing pitch attitude.
5. Landing
6. Short landing run to complete stop.

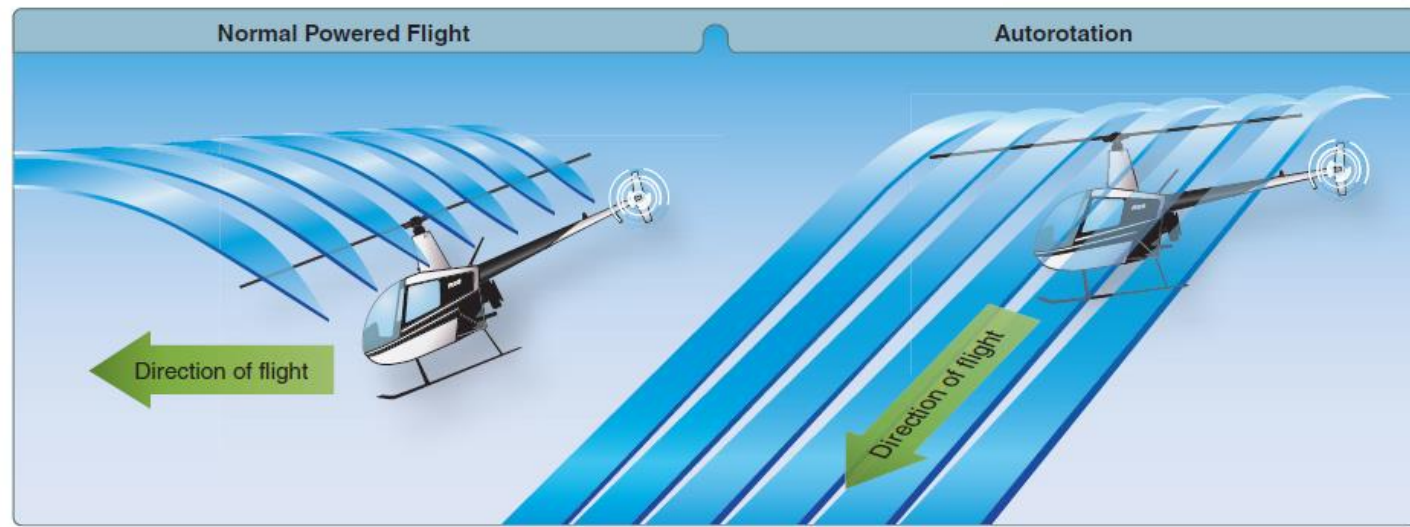

Figure 11-1. During an autorotation, the upward flow of relative wind permits the main rotor blades to rotate at their normal speed. In effect, the blades are “gliding” in their rotational plane.

# AUTOROTATION – CORRECTIVE ACTIONS

## WHY SHOULD YOU WANT TO SIMULATE AUTOROTATION?

Real life does not come with a “re-spawn” button. Life is imperfect: there is always a chance that you could lose engine power for a million reasons. In the world of DCS, odds are that you will be sent on dangerous (read: SUICIDAL) missions. Forget about milk runs: combat landings, close gunship support, CSAR... there are very high chances that you will be fired upon. With so much crap flying in the air, you are bound to get zinged by something. This is why if you enter in an autorotation state, you MUST know what you do.

## HOW TO SIMULATE AUTOROTATION

Autorotation can be simulated if you reduce your throttle to IDLE. Train yourself to deal with autorotation and you will be surprised to see how much better your flying will become.

## AUTOROTATION RECOVERY EXAMPLE:

- 1) Find a good place to land first and make sure you are at 1000 m or more.
- 2) Simulate engine loss of power by reducing throttle to IDLE.
- 3) Push TRIM RESET switch
- 4) Apply left anti-torque pedal to center the helicopter, lower collective and pull up cyclic to compensate for sudden RPM loss: make sure the power turbine reaches 90-100% RPM.
- 5) Adjust cyclic for a constant descent at 100-120 km/h
- 6) Maintain 90-100 % RPM and 100-120 km/h airspeed.
- 7) **RECOVERY MODE: TOUCHDOWN** (no power, continue descent and land)
  - a) Once condition at step 6) is respected , continue descent and do not touch throttle.
  - b) At 100 m AGL, apply aft cyclic to level out and decelerate to 70 km/h for a vertical landing or 100 km/h for a running landing. Descent rate should be around 5-8 m/s.
  - c) At 15-10 m AGL, start flaring and raise collective with decision to cushion the landing: not too fast, not too slow. Keep in mind that you have wheels, not skids. This will be very helpful on landing. Tap your brake lever to slow down once you are on the ground.

Here is a video demonstration of a touchdown autorotation recovery by KATPAH777.

LINK: <https://www.youtube.com/watch?v=cxTYr1nc-sQ>



Altitude (AGL)	Power-On-Glide Airspeed	
	Maximum	Minimum
5000 to 3000 m (16,404 to 9,842 ft)	120 km/h (65 KIAS)	100 km/h (54 KIAS)
3000 to 2000 m (9,842 to 6,561 ft)	150 km/h (81 KIAS)	60 km/h (32 KIAS)
2000 to 0 m (6,561 to 0 ft)	200 km/h (108 KIAS)	60 km/h (32 KIAS)
Altitude (AGL)	Main Rotor Autorotation Glide Airspeed	
	Maximum	Minimum
5000 to 2000 m (16,404 to 6,561 ft)	120 km/h (65 KIAS)	100 km/h (54 KIAS)
2000 to 0 m (6,561 to 0 ft)	180 km/h (97 KIAS)	90 km/h (49 KIAS)

Table 9-2 Power On Descent and Autorotational Glide Speeds

Autorotational Landing Procedures Adjusted for Terrain	
Terrain Type	Procedure
<b>Open and Level</b>	<ol style="list-style-type: none"> <li>At 150 to 200 ft AGL, decelerate the aircraft by adding 15 to 20 degrees nose up pitch to arrive at 30 to 40 feet AGL/30 KIAS.</li> <li>Put the aircraft into landing attitude, 4 to 6 degrees nose high prior to touchdown.</li> <li>Complete roll-on landing.</li> </ol>
<b>Uneven or Broken</b>	<ol style="list-style-type: none"> <li>Initiate greater deceleration, 20 degrees or higher nose up, 30 to 40 feet AGL.</li> <li>Complete vertical landing.</li> </ol>

Table 9-3 Autorotational Landing Procedures Checklist (Adjusted for Terrain)



**FOR NIGHT OPERATIONS:**  
**NIGHT VISION GOGGLES CONTROLS**  
ON/OFF: RSHIFT + H  
BRIGHTNESS + : RCTRL + RSHIFT + H  
BRIGHTNESS - : RALT + RSHIFT + H



# FLIGHT ENVELOPE: HEIGHT VS SPEED & "DEAD MAN'S CURVE"

All helicopters carry an operator's manual that has an airspeed versus altitude chart similar to this one. The shaded area on this chart must be avoided. It is often referred to as the "dead man's curve" and "avoid curve". Proper manoeuvres for a safe landing during engine failure cannot be accomplished in these areas.

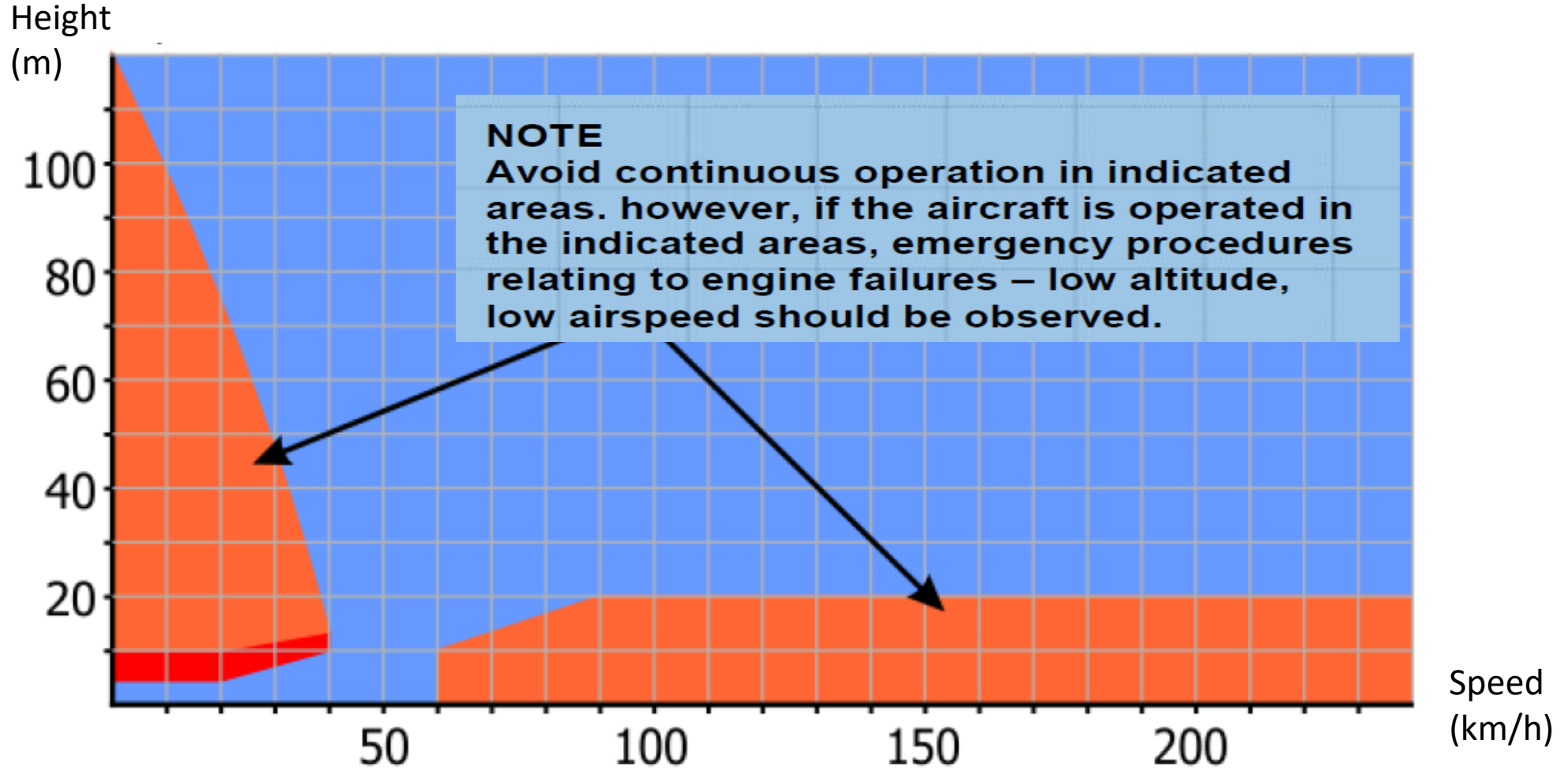

## FLIGHT MODES

Mission planning is a crucial part of flying helicopters. Airmobile operations will often require you to drop troops at a designated LZ (landing zone). The flight path to reach this LZ should be as safe as possible. The Mi-8 can neither fly fast nor high, therefore his safest routes will often be as close to the ground as possible in order to avoid detection and use terrain to mask his approach. "NOE" is what pilots call "Nap-of-the-Earth", a very low altitude flight mode done in a high-threat environment. NOE flying minimizes detection and vulnerability to enemy radar.

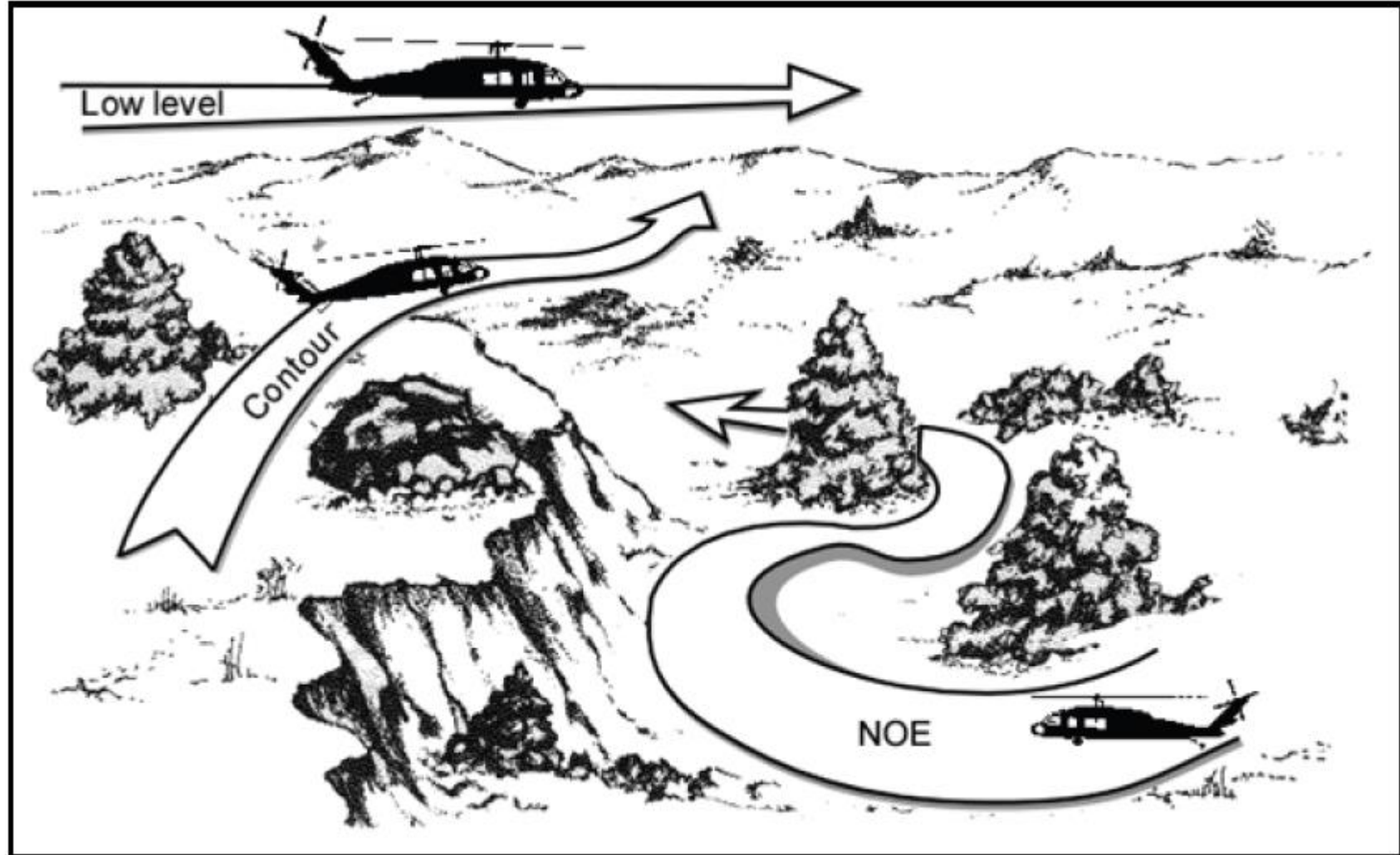



# FORMATIONS

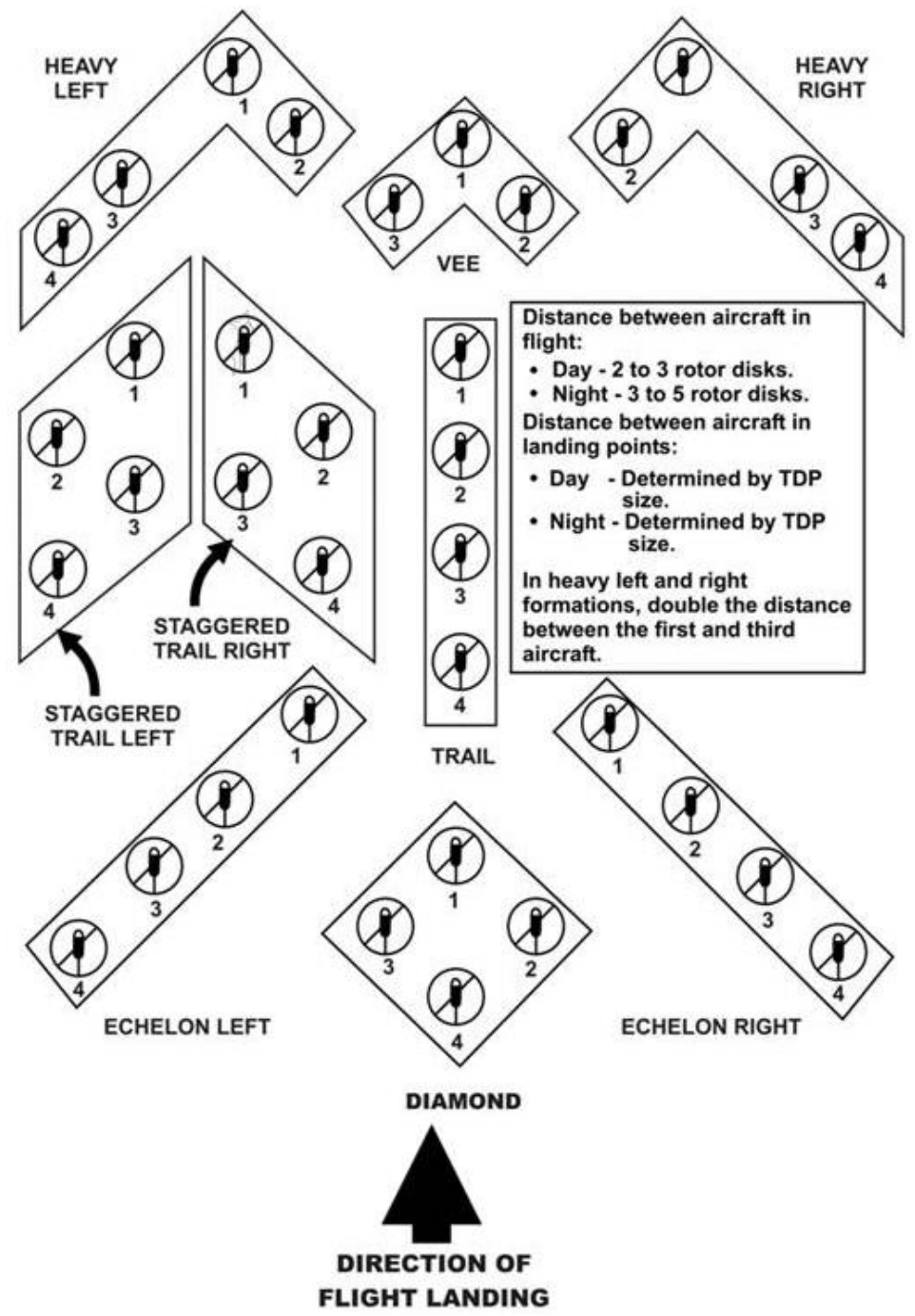
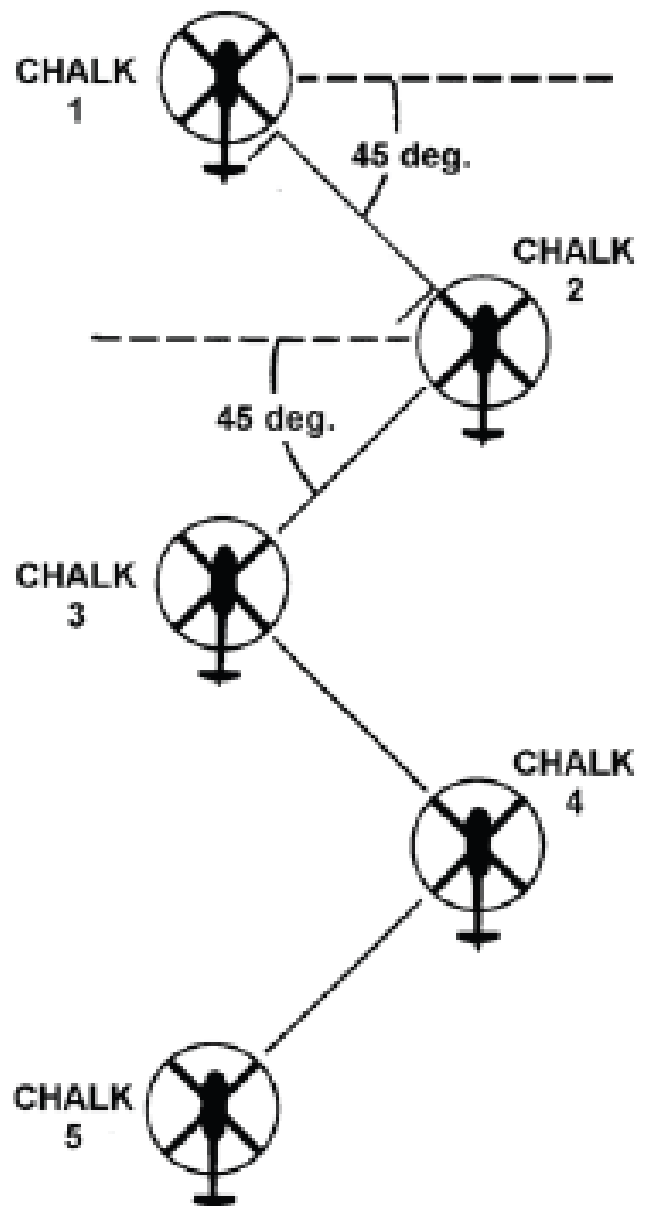

# TROOP DEPLOYMENT

Transport helicopters are called "slicks". Since slicks carry troops and are not heavily armed, they are often escorted by gunships.

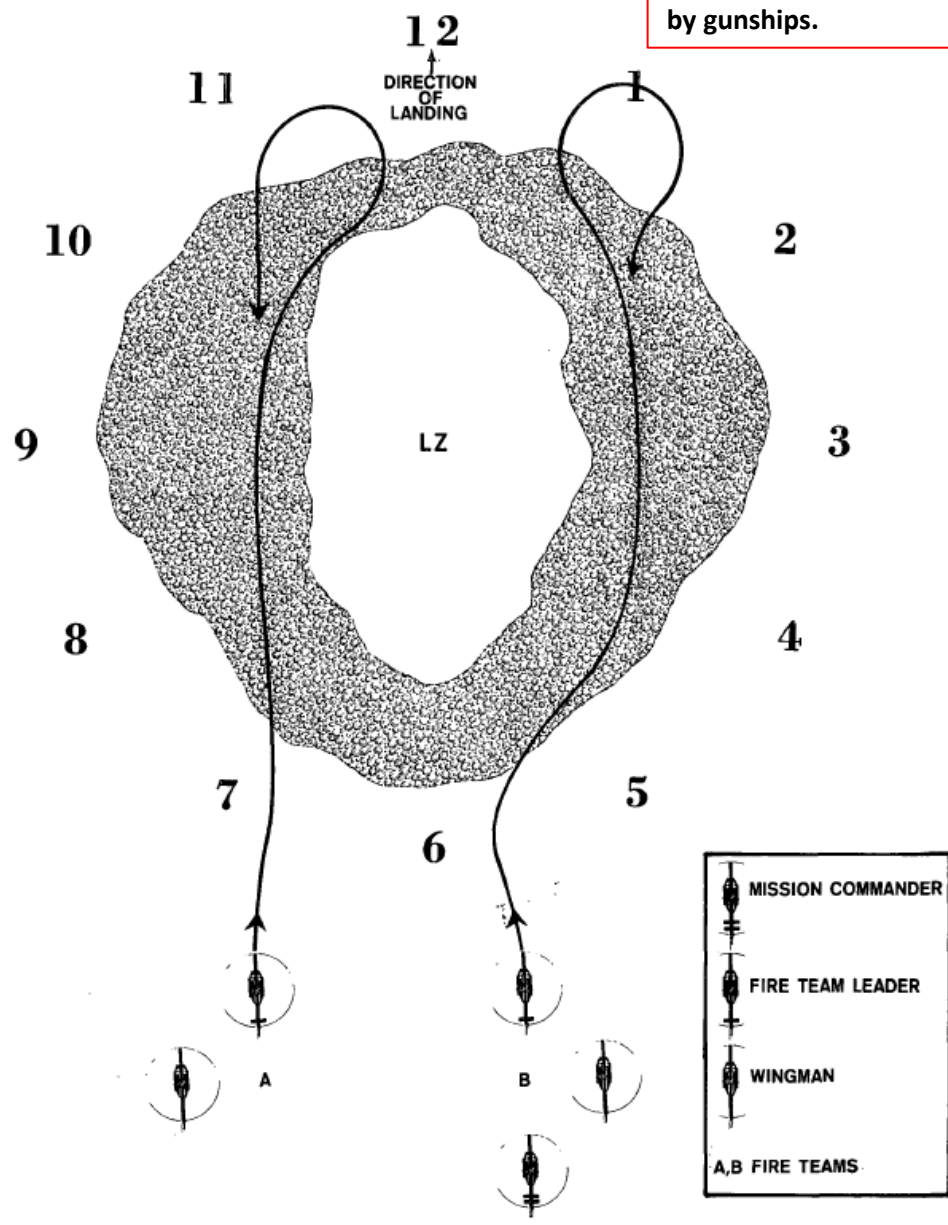

FIRE TEAM A IS RESPONSIBLE FOR LZ COVERAGE FROM 7 TO 1 O'CLOCK.  
FIRE TEAM B IS RESPONSIBLE FOR LZ COVERAGE FROM 6 TO 2 O'CLOCK.

aavn 784

Figure 26. Double orbit of the landing zone.

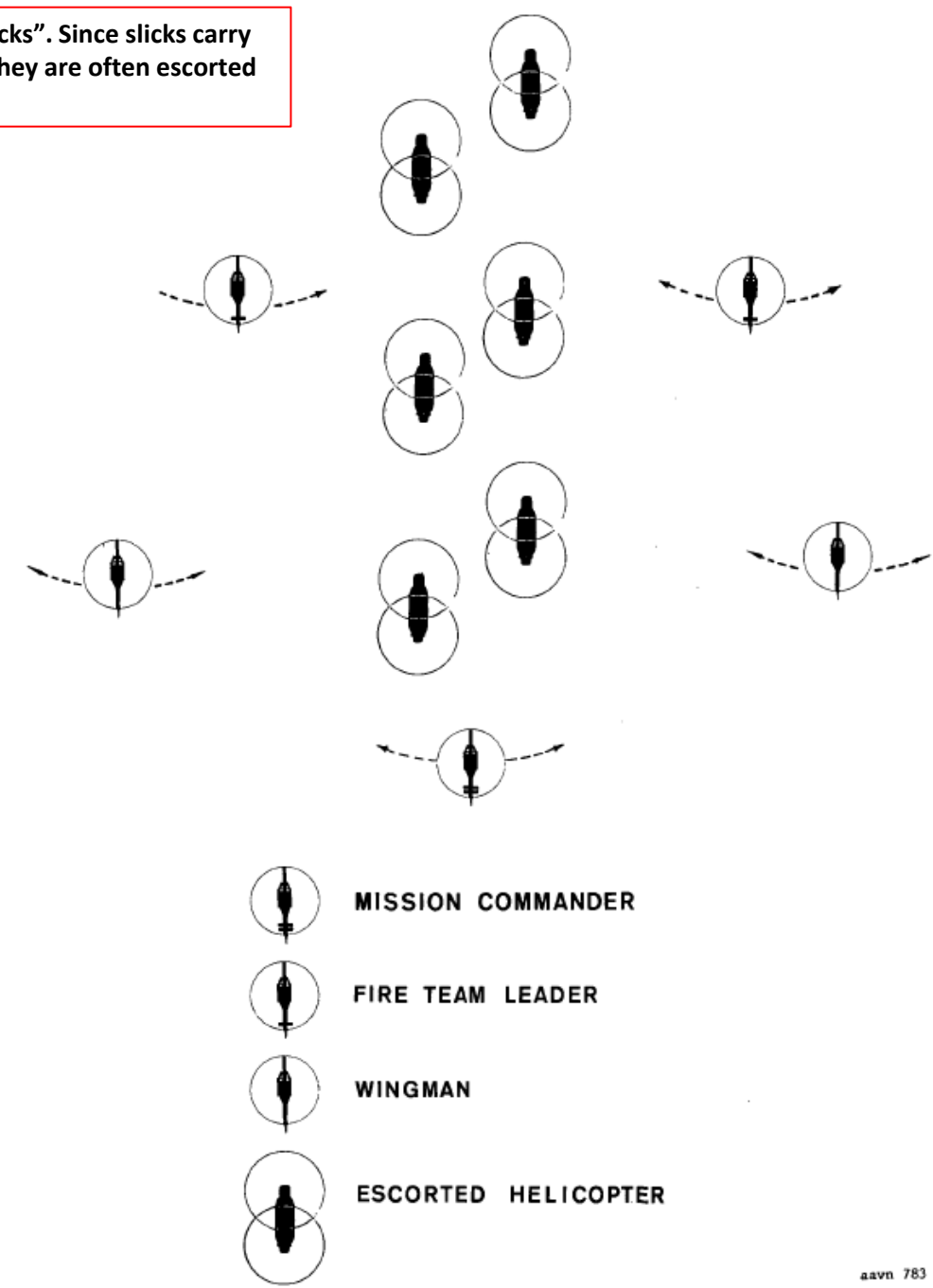

Figure 25. Escort formation at tree-top level or nap-of-the-earth.

aavn 783



## HOW TO LOAD AND DROP TROOPS (CTLD SCRIPT)

1. Land next to ground troops
2. Press “\” to open the main menu
3. Press “F10” to select Other
4. Press “F3” to select CTLD
5. Press “F1” to select Troop Transport
6. Select troops you want to load by pressing either “F3”, “F4”, “F5” or “F6”.
7. To Unload / Extract Troops, repeats steps 2) through 5), then press “F1”

2

```

Main
F1. Flight...
F2. Wingman 2...
F3. Wingman 3...
F4. Wingman 4...
F5. ATC...
F6. All Cargos...
F7. Airborne Troops...
F8. Ground Crew...
F10. Other...
F12. Exit
  
```

3

```

3. Main. Other. CTLD
F1. Troop Transport...
F2. AA Crates...
F3. Ground Forces...
F4. CTLD Commands...
F5. Smoke Markers...
F6. Radio Beacons...
F11. Previous Menu
F12. Exit
  
```

5

```

2. Main. Other
F1. CSAR...
F2. FAC Status
F3. CTLD...
F4. JTAC Status
F11. Previous Menu
F12. Exit
  
```

4

```

4. Main. Other. CTLD. Troop
Transport
F1. Unload / Extract Troops
F2. Check Cargo
F3. Load Standard Group
F4. Load Anti Air
F5. Load Anti Tank
F6. Load Mortar Squad
F11. Previous Menu
F12. Exit
  
```

7a

6a

New callsign loaded troops into MI-8MT

6b

New callsign troops dropped from MI-8MT into combat

7b





## SLING LOADS

- Land next to cargo crates
- Press “\” to open the main menu
- Press “F6” to select ALL CARGOS
- Press the key specified to choose the cargo you will pick. Its location will be identified by a red smoke.
- Hover about 10 ft (approx. 3 meters) above the target. The Flight engineer will give you corrections (i.e. “Forward, Left.”) Consult the **Doppler Hover & Low Speed Control Indicator** for help.
- Press **External Cargo Hook** key binding (RCtrl+RShift+L) to request a ground crew to attach cargo to the hoist cable.



**b**

```
Main
F1. Flight...
F2. Wingman 2...
F3. Wingman 3...
F4. Wingman 4...
F5. ATC...
F6. All Cargos...
F8. Ground Crew...
F10. Other...
F12. Exit
```

**c**

**d**

```
2. Main. All Cargos
F1. 2205 lb - UH-1H cargo
F2. 2205 lb - UH-1H cargo #005
F3. 2205 lb - UH-1H cargo #001
F4. 2205 lb - UH-1H cargo #006
F5. 2205 lb - UH-1H cargo #002
F6. 2205 lb - UH-1H cargo #007
F7. 2205 lb - UH-1H cargo #003
F8. 2205 lb - UH-1H cargo #008
F9. 2205 lb - UH-1H cargo #004
F10. 2205 lb - UH-1H cargo #009
F11. Previous Menu
F12. Exit
```

Cargo selection menu appearance depends on distance to cargo

**a**

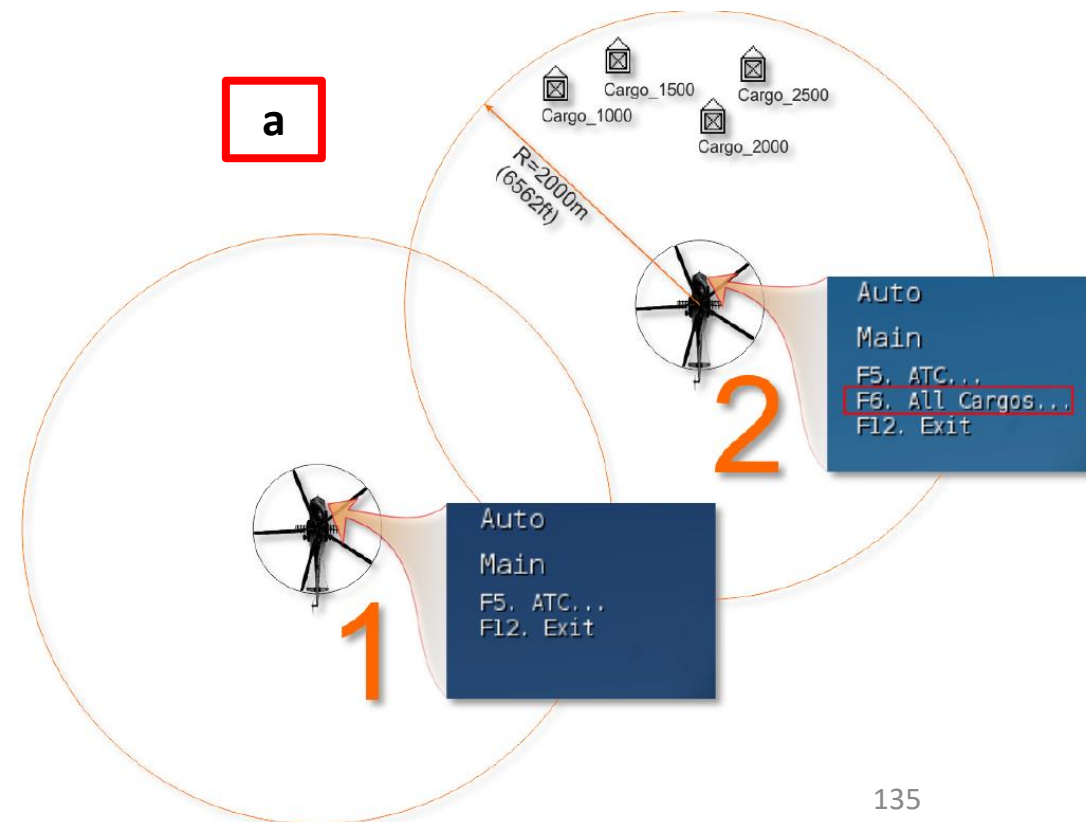



## SLING LOADS

- e. Hover about 10 ft (approx. 3 meters) above the target. The Flight engineer will give you corrections (i.e. "Forward, Left.") Consult the **Doppler Hover & Low Speed Control Indicator** for help.
- f. Press **External Cargo Hook** key binding (RCtrl+RShift+L) to request a ground crew to attach cargo to the hoist cable.

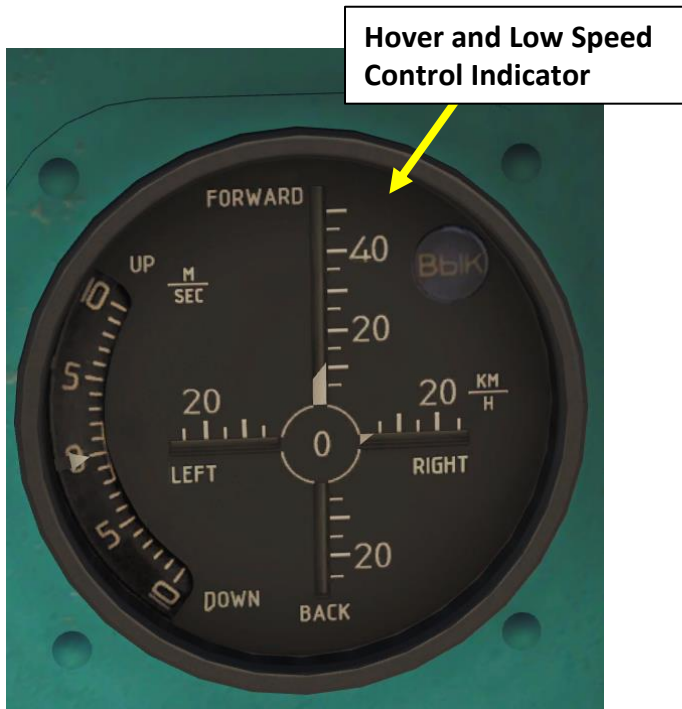



## SLING LOADS

- g. When the Flight Engineer tells you “Take Tension”, raise collective to gain altitude and create tension on the hoist cable. You will then be able to fly away with the sling load.
- h. You can press “3” to select the Flight Engineer, which will now be relocated in the aft cabin, watching over the cargo hoist.
- i. When you fly, be mindful of the pendulum effect the cargo will have. Do not make hard turns or the hoist cable will snap.
- j. To drop cargo, maintain a hover above drop zone
- k. On the collective, flip the DROP CARGO safety switch, then unhook the cargo by pressing the **External Cargo Tactical Unhook** key (RCtrl+Rshift+RAIt+L) binding to detach cargo.

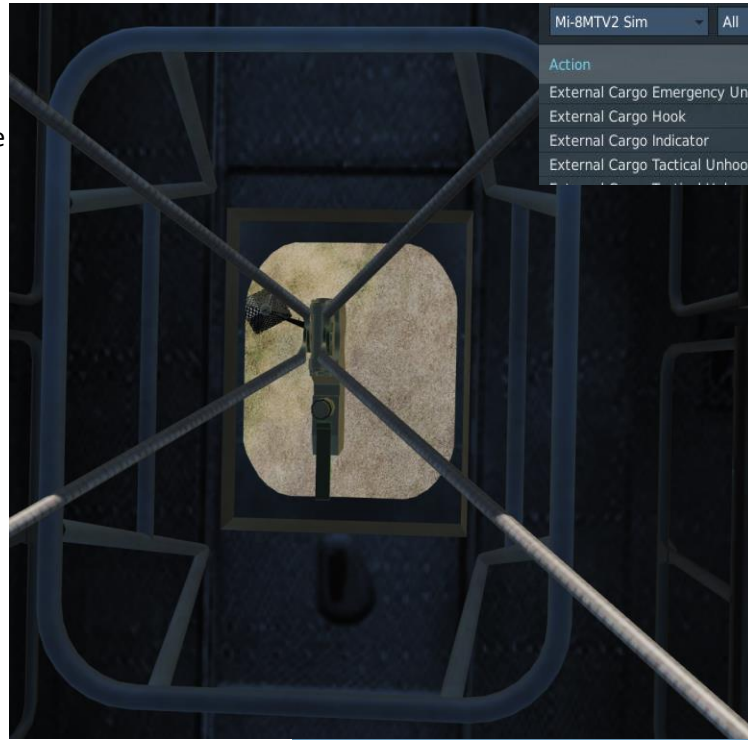

Action	Category	Keyboard	Throttle - HOTAS W...
External Cargo Emergency Unhook Button Cover - OPEN/CLOSE	Ins Collective Stick, Extern	RCtrl + RShift + RAlt	
External Cargo Hook	External Cargo	RCtrl + RShift + L	JOY_BTN11
External Cargo Indicator	External Cargo	RCtrl + RShift + P	
External Cargo Tactical Unhook	Ins Collective Stick, Extern	RCtrl + RShift + RAlt	JOY_BTN12





# WEAPONS – INTRODUCTION

It is quite interesting to see how the Mi-8 was not originally built as a gunship. Mi-8s were first used for combating the insurgents in Afghanistan long before the Soviet invasion. These helicopters were operated by the Government troops. The first Soviet Mi-8T squadron was deployed in Afghanistan in the summer of 1979. At first it did not take part in the hostilities and was used only for communications and VIP transportation. However, on 25th December of that year Soviet helicopter units started a massed airlifting of troops and delivery of assault groups tasked with capturing airfields and key positions.

When it came to fulfilling combat missions, especially when pinpoint bombing was required, the 'eights' could successfully supplant not only combat helicopters but also tactical bombers. On many occasions the Mi-8s were sent to bomb small-size targets or targets which could not be destroyed by fast movers.

You have the following weapon types at your disposal:

- B-8V20A rocket pod – 20 x S-8 rockets
- UPK-23-250 gun pod –Gsh-23 23 mm twin-barrel cannons
- GUV-8700 gun pod
  - VARIANT 1: 9-A-800 automatic grenade launcher
  - VARIANT 2: YakB 9-A-624/622 (1 x 12.7 mm + 2 x 7.62 mm four-barrel Gatling machineguns)
- FAB-100/250/500 HE bombs

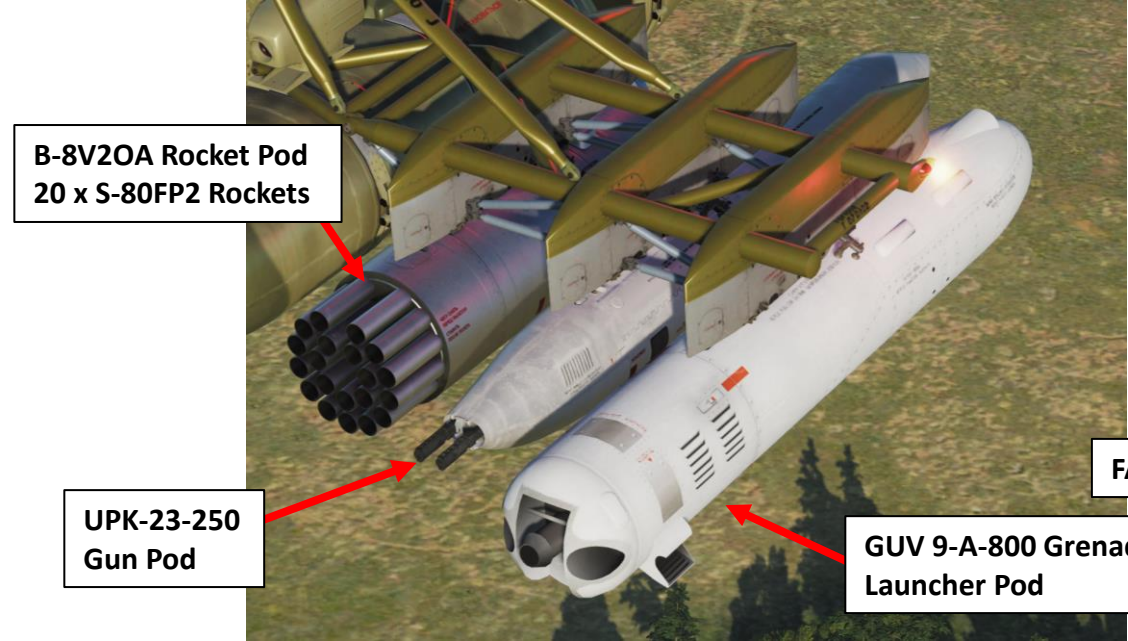

# WEAPONS CHART (CREDITS TO CHIC FROM THE 229<sup>TH</sup>)

MI-8MTV2  
HIP

## PART 12 – WEAPONS & COUNTERMEASURES

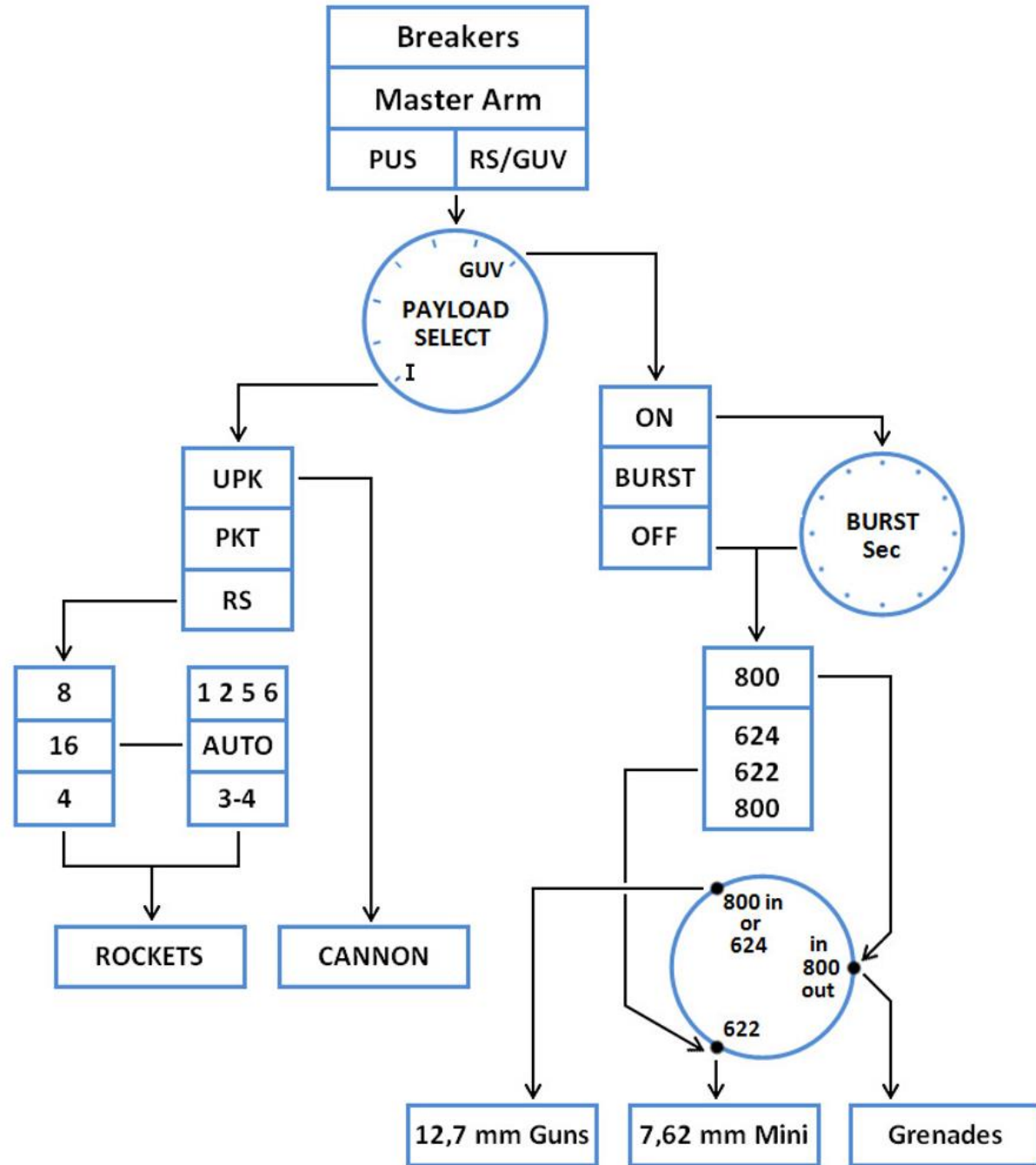



# WEAPONS – AIMING RETICLE

Here is a nice aiming tutorial created by "Teach Yourself DCS".  
<https://www.youtube.com/watch?v=ijy1l34GhjE>



Рис. 9.128. PKV collimating sight (front and side view)

- 1- sight elevation knob
- 2- mechanical ring sight (stowable)
- 3- reflector glass
- 4- sun filter glass (stowable)



# WEAPONS – AIMING RETICLE

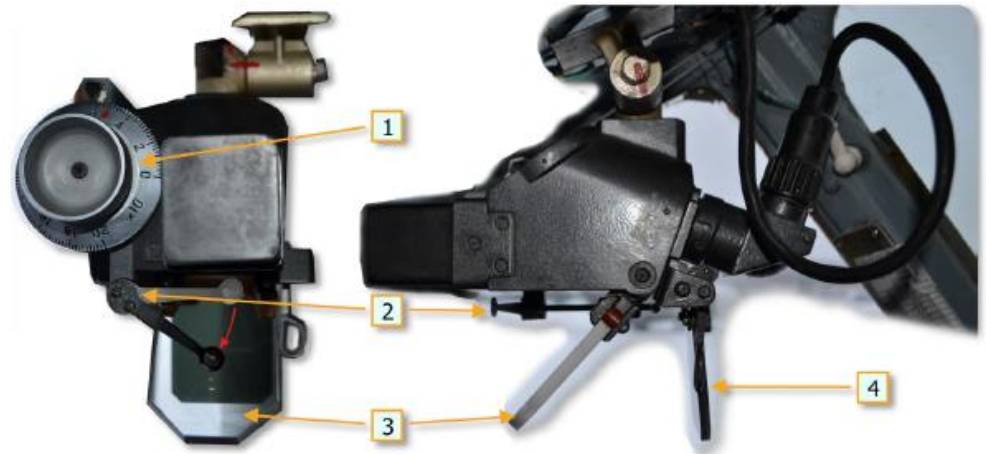
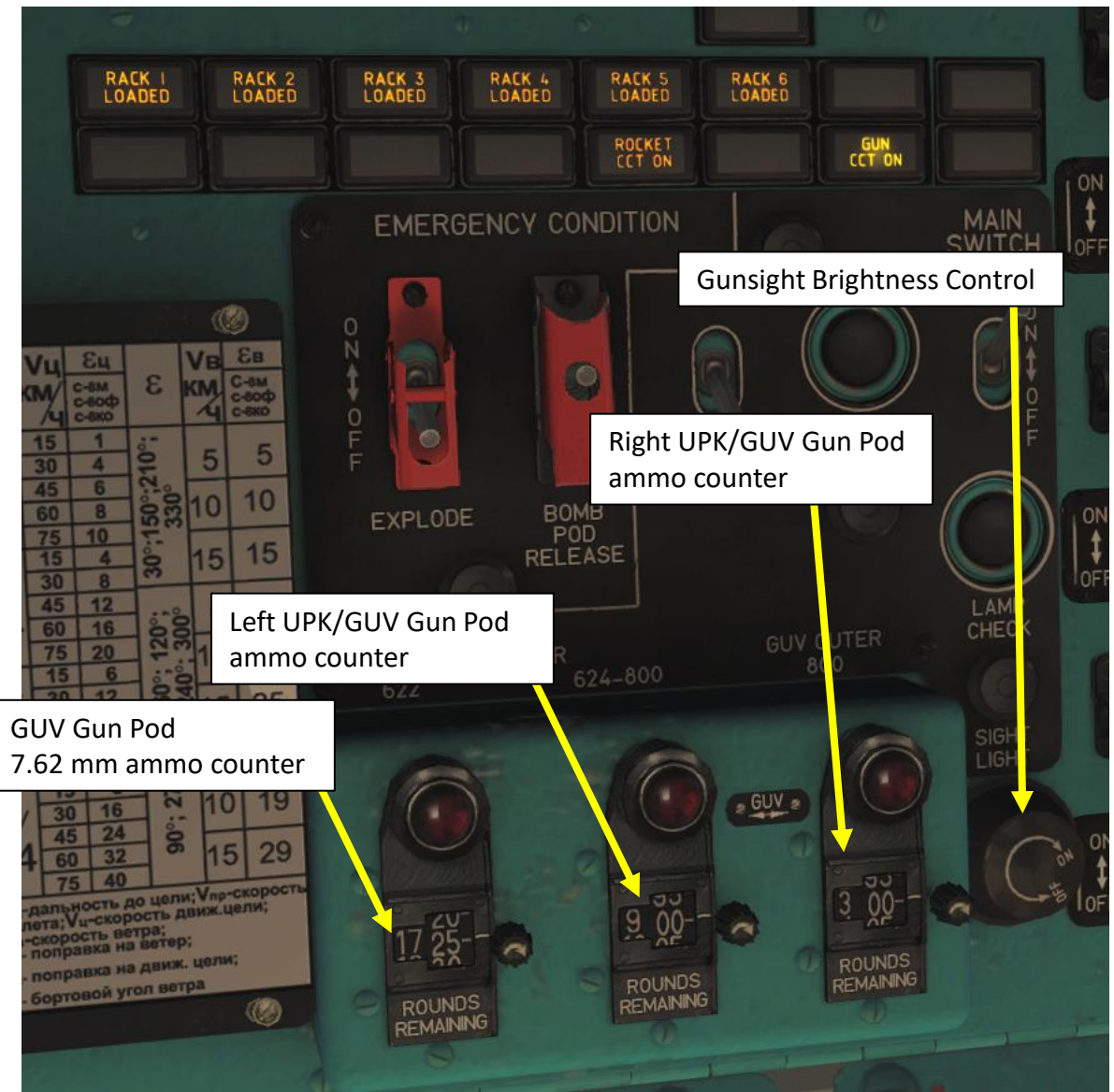
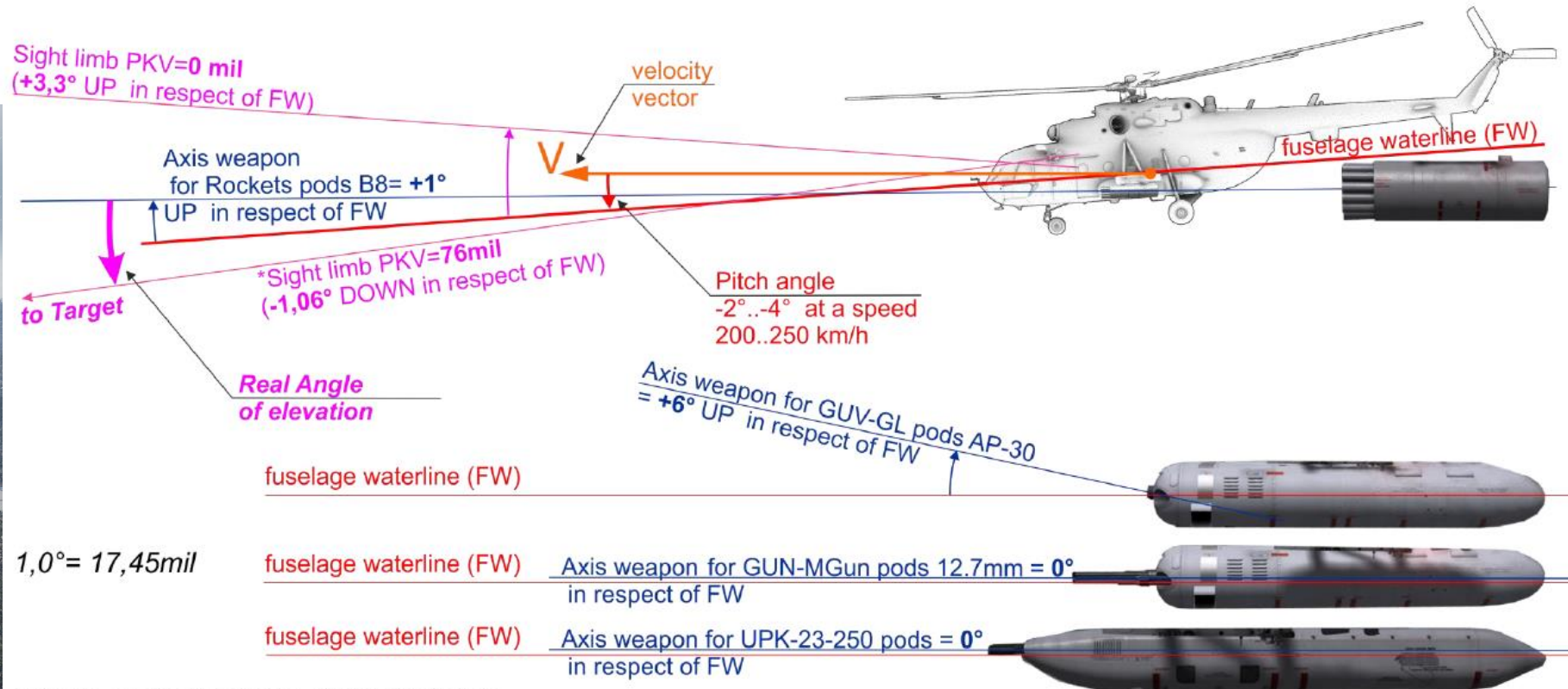

1,0° = 17,45mil

\*76mil - angle of elevation at limb PKV sight for air speed 200km/h and target distance 2000m

Fig. 11.11. Elevation angles relevant to weapons employment using the PKV collimating sight.



# HOW TO FIRE UPK-23-250 GUN PODS

- 1) Turn ON weapon system breakers
- 2) Turn ON Master Arm on roof panel
- 3) Set Payload Management Selector to POD I
- 4) Set Weapon Selector Switch to УПК/UPK (UP)
- 5) Turn Main Weapons Power ON (UP)
- 6) Press "Weapon Release" button (Spacebar)

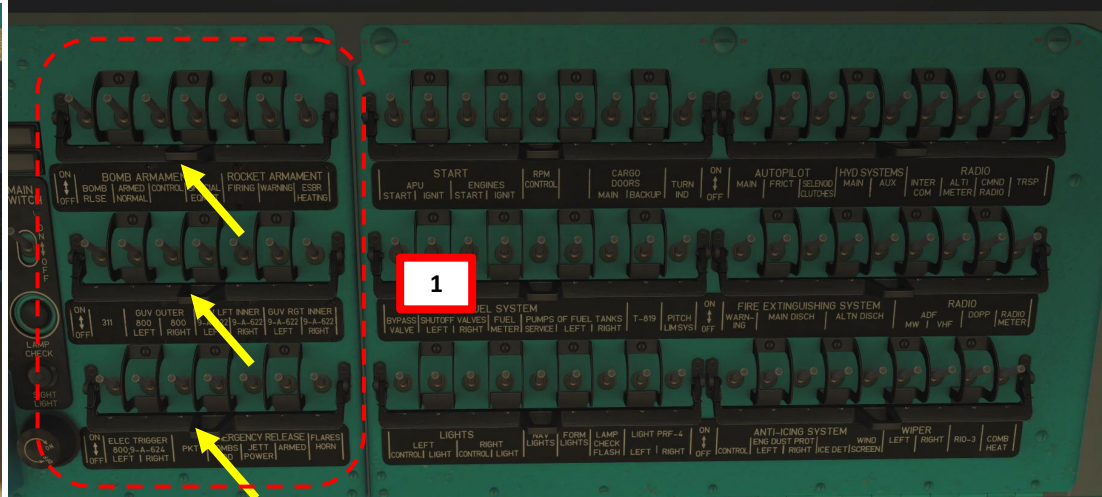

Weapon Selector Switch  
**TOP:** UPK 23 mm cannon  
**MIDDLE:** PKT nose machine-gun (not funct.)  
**DOWN:** RKT/PC 80 mm rockets

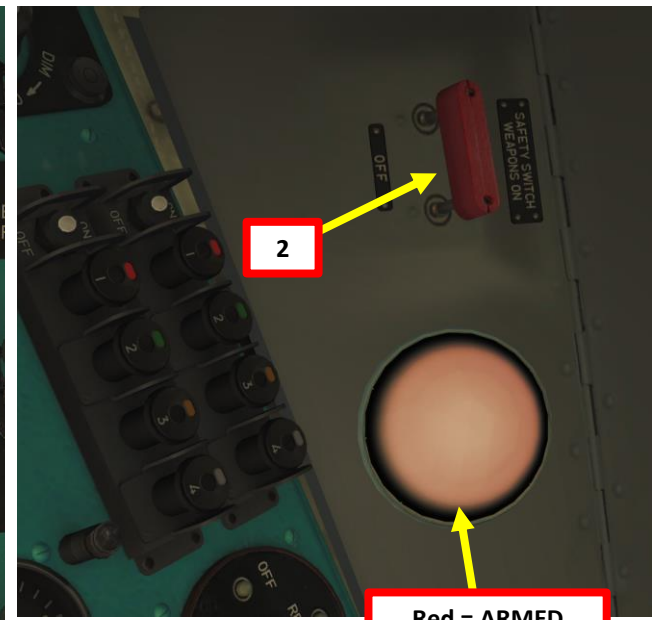
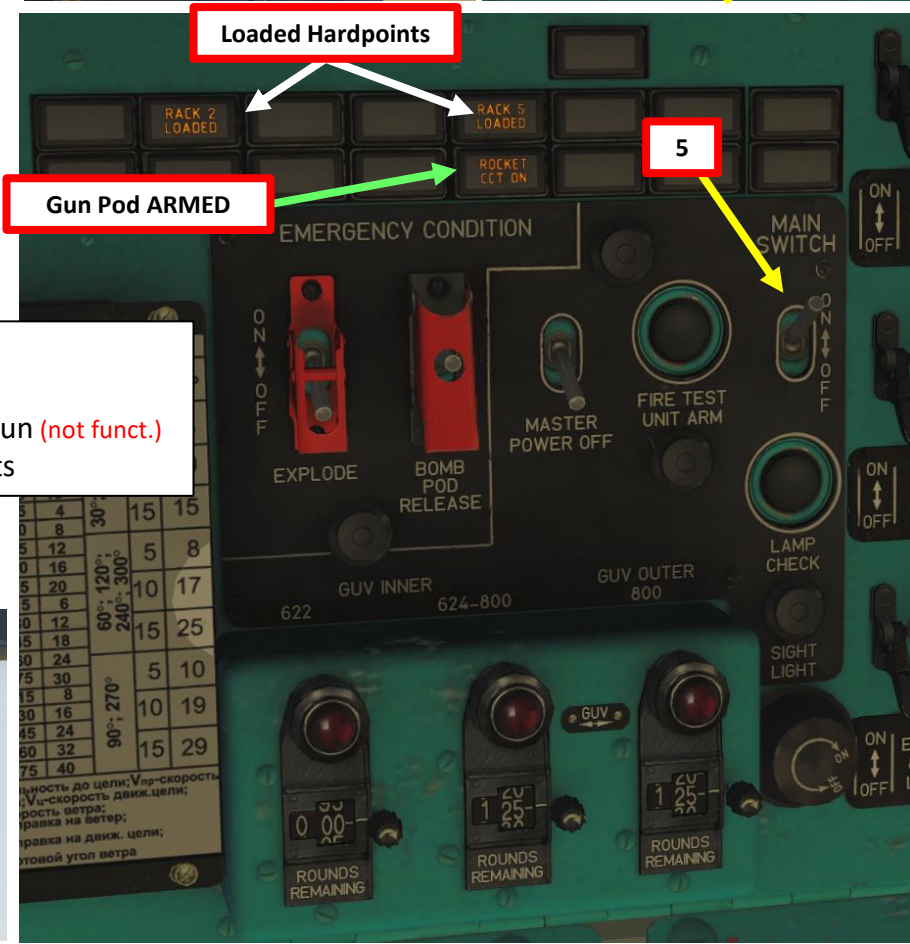



# HOW TO FIRE UPK-23-250 GUN PODS





# HOW TO FIRE GUV GUN PODS – 9-A-624/622 MACHINEGUN VARIANT

- 1) Turn ON weapon system breakers
- 2) Turn ON Master Arm on roof panel
- 3) Set Payload Management Selector to GYB (GUV)

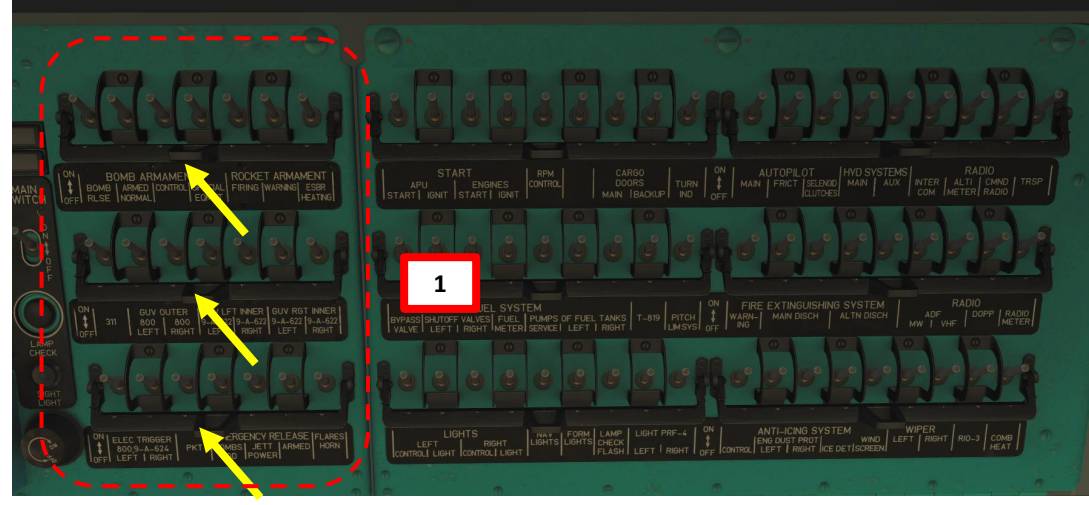
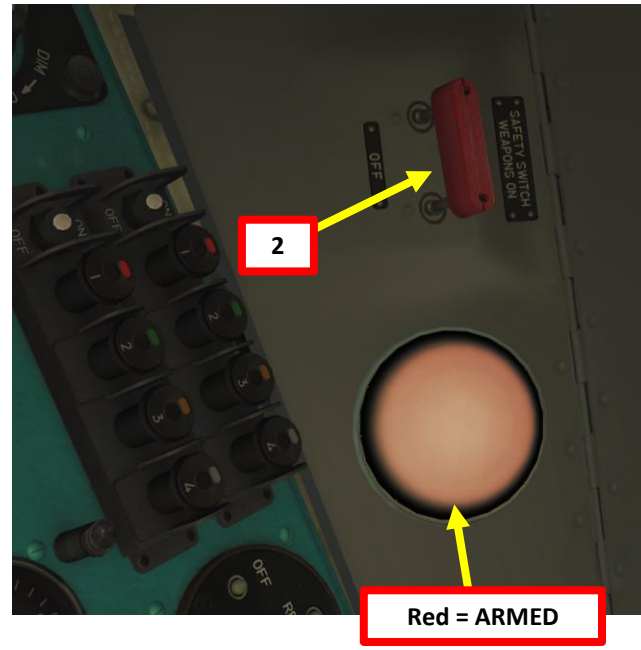

## Firing the GYB-8700 gun pods 9-A-624/622

The 9-A-624/622 version of the GUV-8700 gun pod features a single YakB 12.7 mm 4-barrel gatling machine gun and two GShG 7.62 mm 4-barrel gatling machine guns. Only one of the two systems can be fired at a time.



# HOW TO FIRE GUV GUN PODS – 9-A-624/622 MACHINEGUN VARIANT

- 4) Select desired firing mode (burst firing mode ON or OFF) and burst fire length if burst firing mode is selected.
- 5) A) Select desired GUV gun mode
  - 800/624 for 12.7 mm guns
  - 622 for 7.62 mm guns
 B) If 12.7 mm guns are selected, press reload keys for left and/or right pods (can be set to I, II or III, it doesn't matter).
- 6) Select GUV 624/622+800 switch (DOWN)
- 7) Turn Main Weapons Power ON (UP)
- 8) Press "Weapon Release" button (Spacebar)



GUV Fire Burst Cutoff Switch  
**UP:** Burst Firing Mode ON  
**DOWN:** Burst Firing Mode OFF

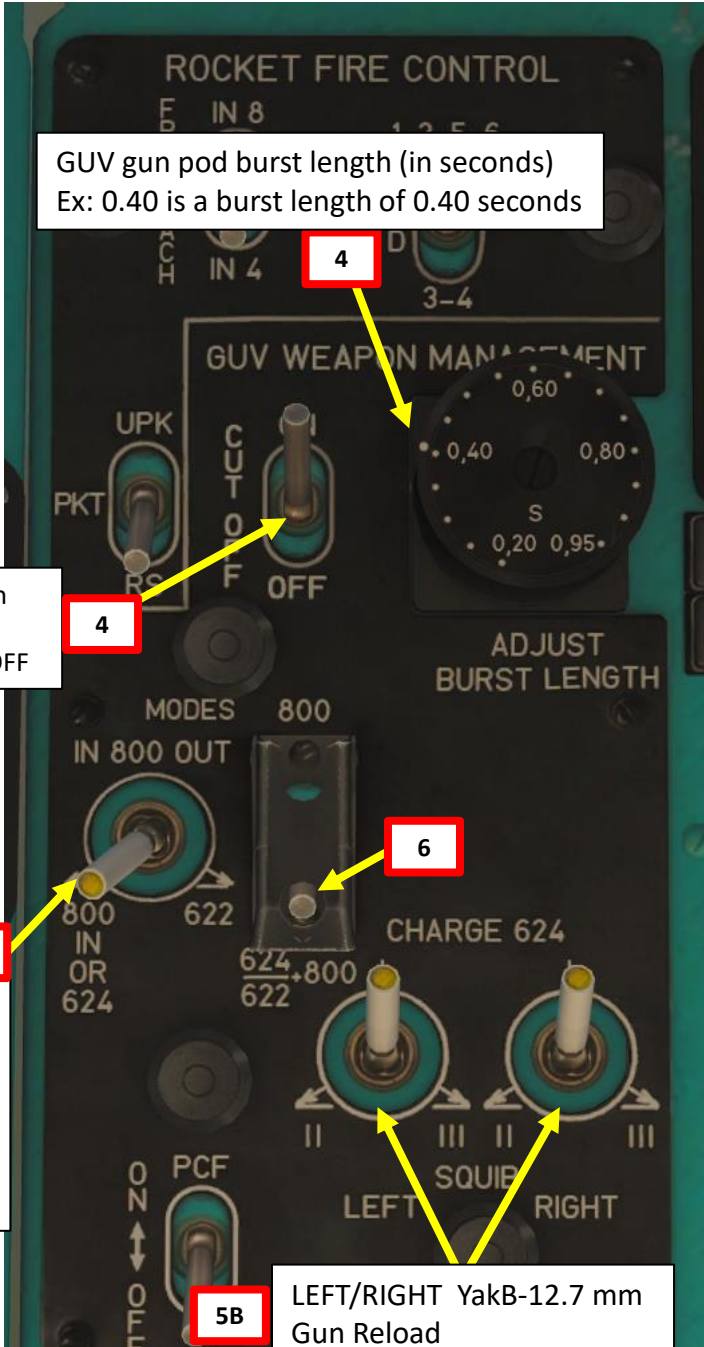

GUV gun pod burst length (in seconds)  
 Ex: 0.40 is a burst length of 0.40 seconds

GUV gun pod Firing Mode Selectors  
**800:** 30 mm grenade launcher (outer stations)  
**800/624:** GShG-12.7 mm mg pods or 30 mm grenade launcher if equipped  
**622:** GShG-7.62 mm machine-gun

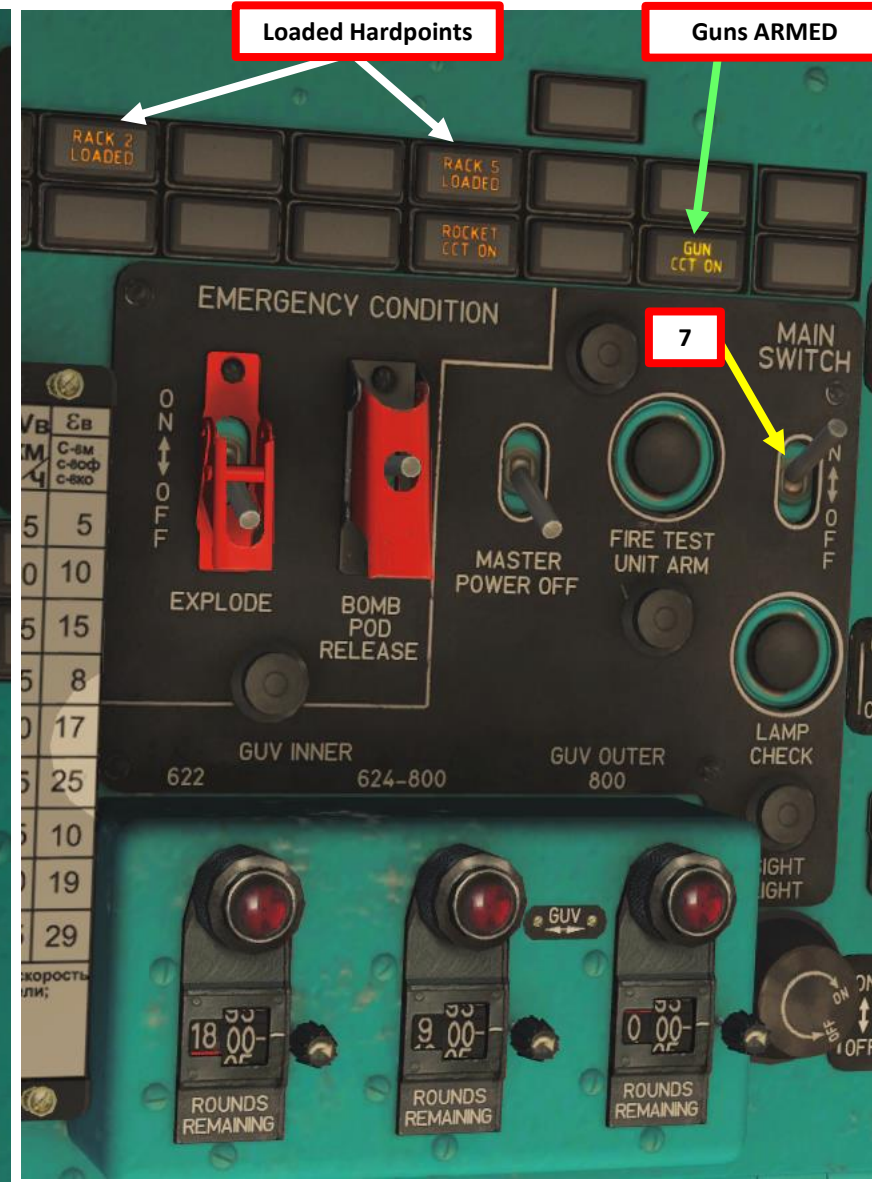



# HOW TO FIRE GUV GUN PODS – 9-A-624/622 MACHINEGUN VARIANT

MI-8MTV2  
HIP

PART 12 – WEAPONS & COUNTERMEASURES



# HOW TO FIRE GUV GUN PODS – 9-A-800 GRENADE LAUNCHER VARIANT

- 1) Turn ON weapon system breakers
- 2) Turn ON Master Arm on roof panel
- 3) Set Payload Management Selector to GUV (GUV)

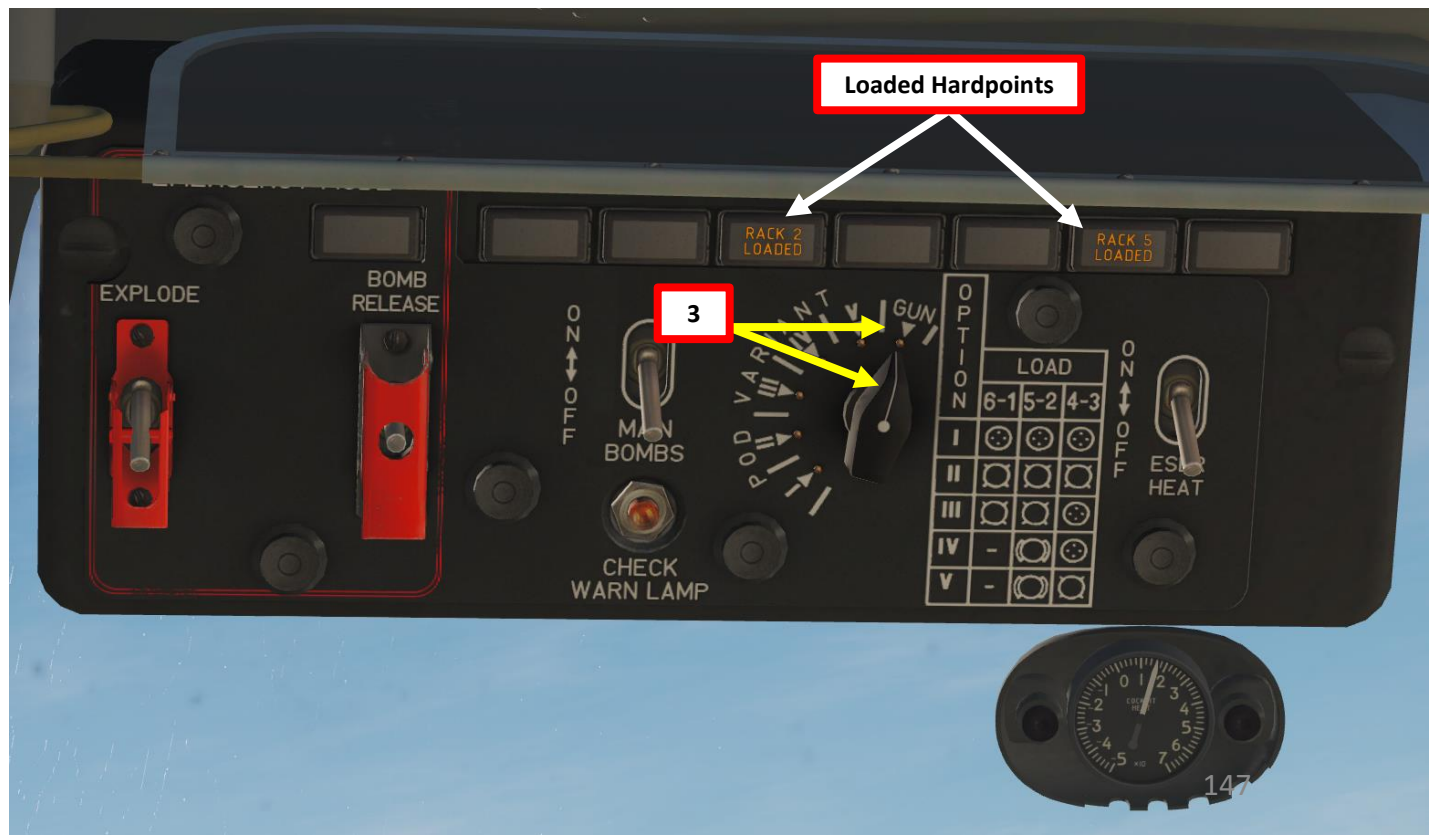
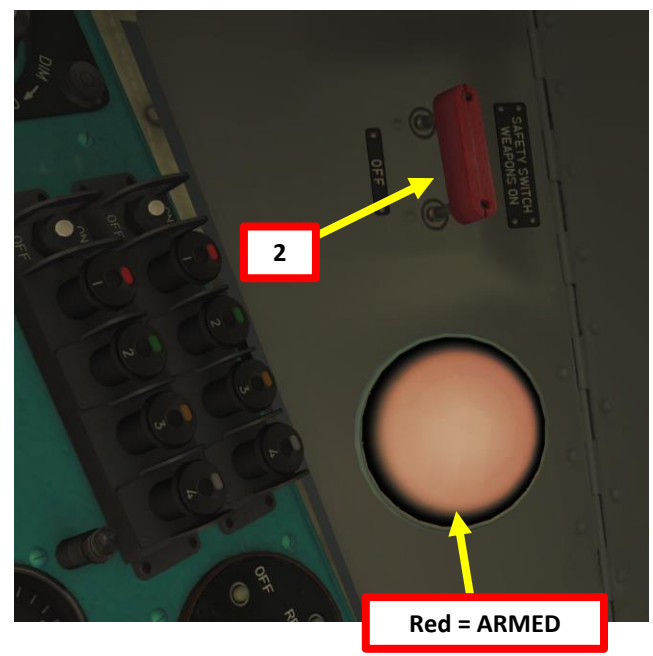
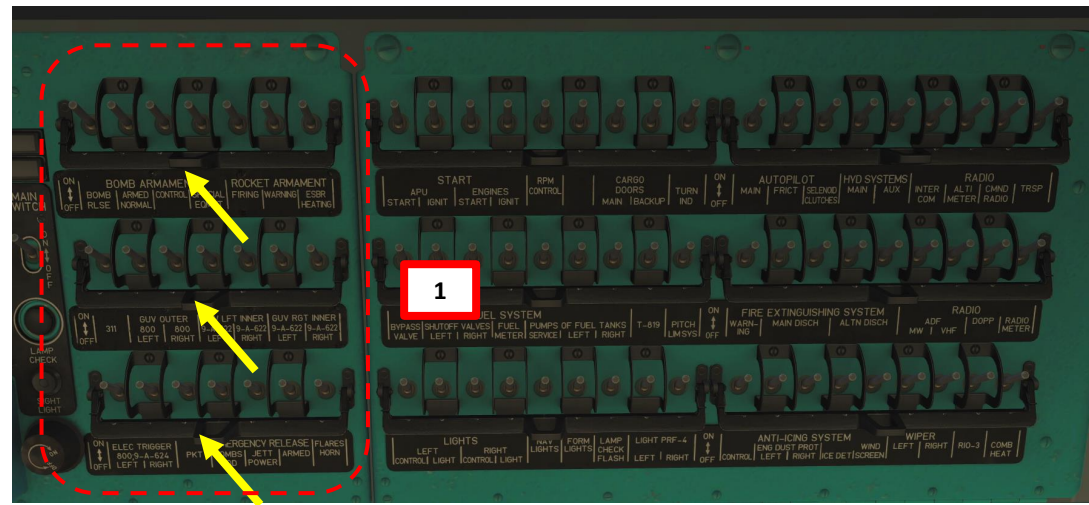



# HOW TO FIRE GUV GUN PODS – 9-A-800 GRENADE LAUNCHER VARIANT

- 4) Select desired firing mode (burst firing mode ON or OFF) and burst fire length if burst firing mode is selected.
- 5) Select desired GUV gun mode
  - 800 for grenade launchers
- 6) Select GUV 800 switch (UP)
- 7) Turn Main Weapons Power ON (UP)
- 8) Press “Weapon Release” button (Spacebar)



GUV Fire Burst Cutoff Switch  
**UP:** Burst Firing Mode ON  
**DOWN:** Burst Firing Mode OFF

GUV gun pod burst length (in seconds)  
 Ex: 0.40 is a burst length of 0.40 seconds

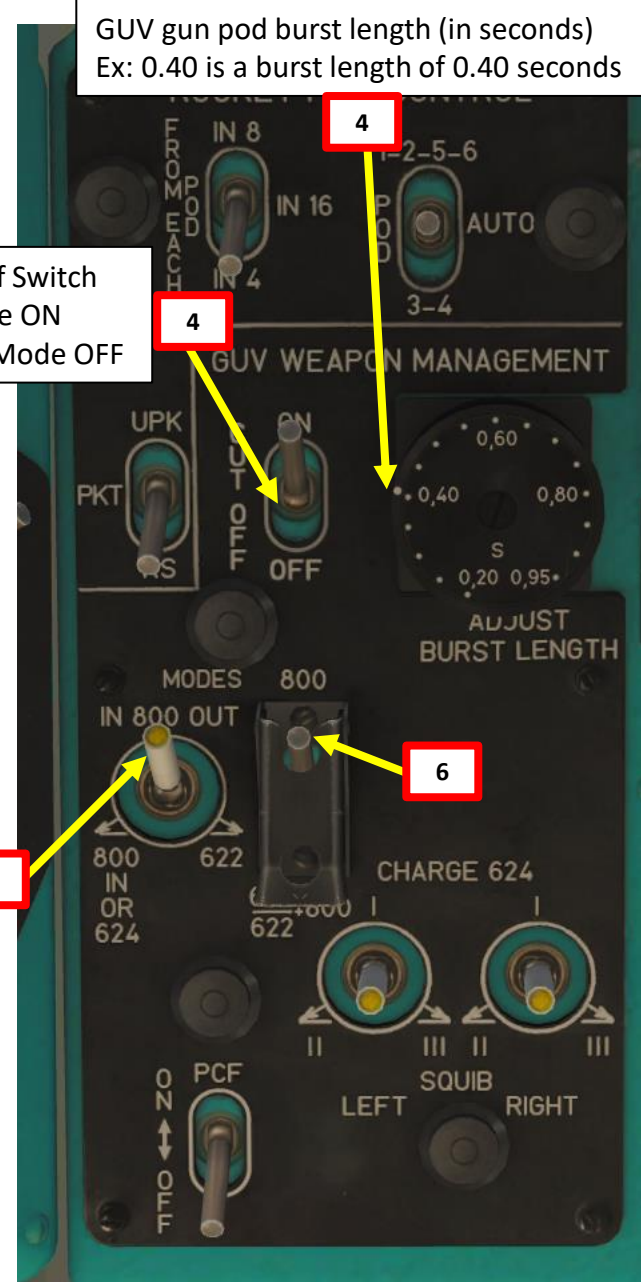

GUV gun pod Firing Mode Selectors  
**800:** 30 mm grenade launcher (outer stations)  
**800/624:** GShG-12.7 mm mg pods or 30 mm grenade launcher if equipped  
**622:** GShG-7.62 mm machine-gun

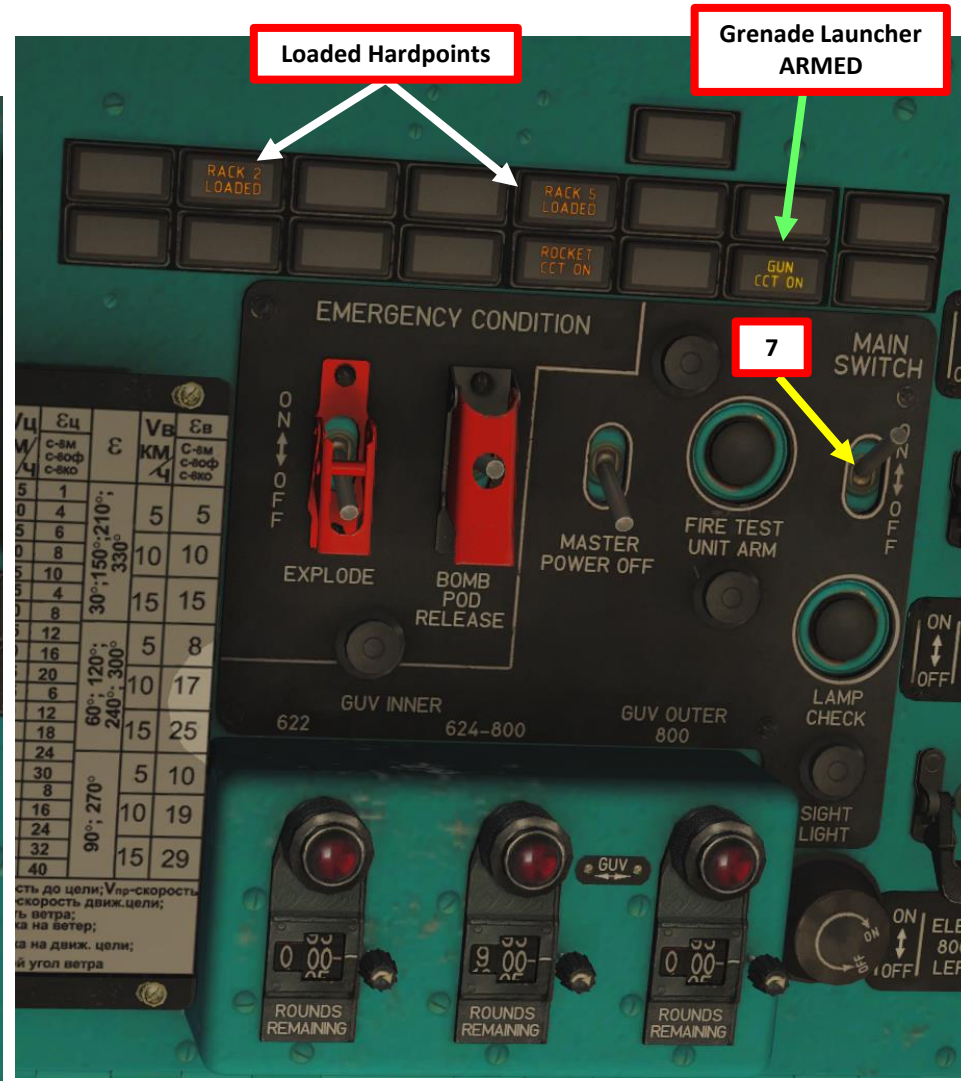



# HOW TO FIRE GUV GUN PODS – 9-A-800 GRENADE LAUNCHER VARIANT

MI-8MTV2  
HIP

PART 12 – WEAPONS & COUNTERMEASURES





# HOW TO FIRE ROCKETS

- 1) Turn ON weapon system breakers
- 2) Turn ON Master Arm on roof panel
- 3) Set Payload Management Selector to POD I
- 4) Select desired Rocket Burst Quantity
- 5) Select rocket pod stations (ABT = AUTO)
- 6) Select ROCKET (PC/RS) firing mode (DOWN)

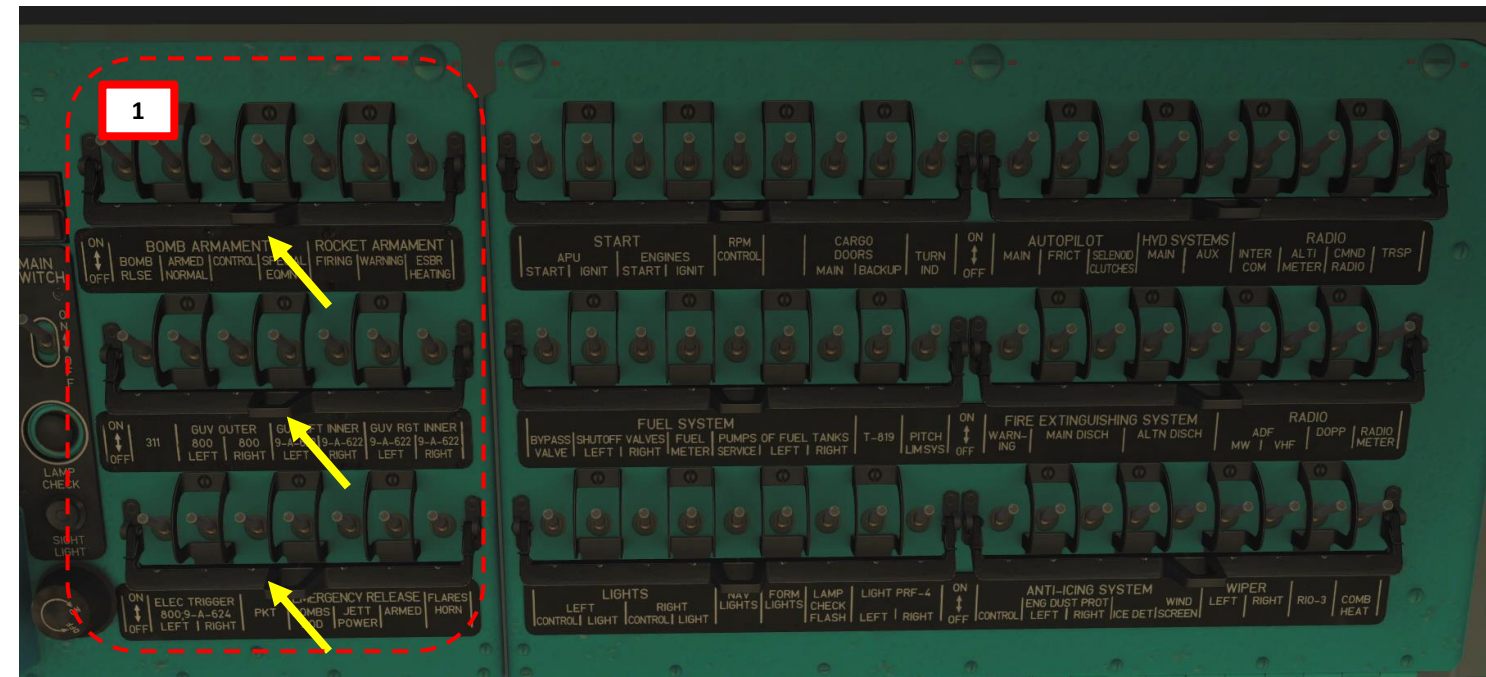
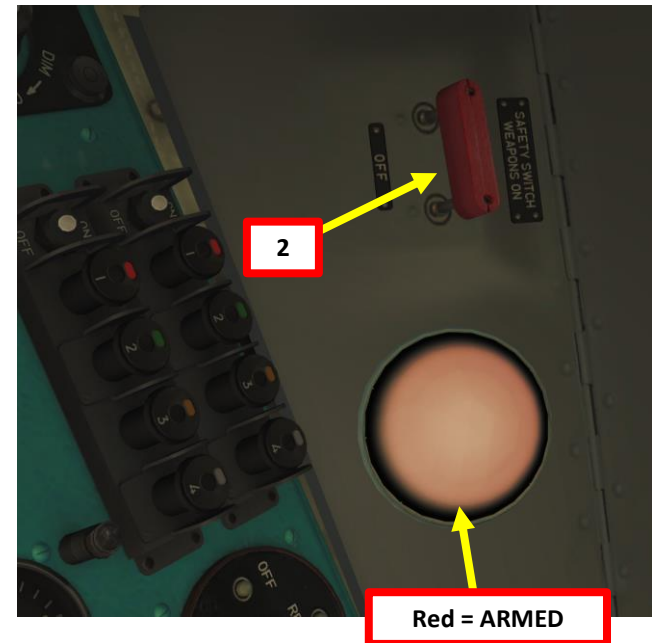



# HOW TO FIRE ROCKETS

- 7) Press PUS Fire Control Unit Power Switch for 1-2 seconds
- 8) Turn Main Weapons Power Switch ON (UP)
- 9) Press "Weapon Release" button (Spacebar)



**Loaded Hardpoints** (points to RACK 1-6 LOADED)

**Rockets ARMED** (points to ROCKET CCT ON)

**PUS ARMED** (points to FIRE EXT 1-6 ARMED)

**7** (points to PUS Fire Control Power Switch)

**8** (points to Main Weapons Power Switch UP = ON)

**9** (points to Weapon Release button)

Vц	εц	ε	Vв	εв
км/ч	С-8М С-80Ф С-8Х0	С	км/ч	С-8М С-80Ф С-8Х0
15	1	30°; 150°; 210°; 330°	5	5
30	4		10	10
45	6		15	15
60	8		5	8
75	10	60°; 120°; 240°; 300°	10	17
15	4		15	25
30	8		5	10
45	12		10	19
60	16	90°; 270°	15	29
75	20			
15	6			
30	12			
45	18			
60	24			
75	30			
15	8			
30	16			
45	24			
60	32			
75	40			

Labels on panel: EMERGENCY CONDITION, EXPLODE, BOMB POD RELEASE, GUV INNER, MASTER POWER OFF, FIRE TEST UNIT ARM, MAIN SWITCH, LAMP CHECK, SIGHT LIGHT, ROUNDS REMAINING, GU, GU, GU.





MI-8MTV2  
HIP

# HOW TO FIRE ROCKETS

## PART 12 - WEAPONS & COUNTERMEASURES





## HOW TO DROP BOMBS

Bombing in the Mi-8 is quite an art. One of the peculiarities of the bombing system is that there is a release order. Bombs **HAVE** to drop in a sequence that makes sense because a helicopter is an extremely unstable machine. The farther from the center of gravity of your helicopter a payload is, the bigger the effect it will have on your stability. From a physical perspective, it is better for your helicopter's stability to drop the bombs that will make you more unstable first, right? This is why bombs have a sequence drop: outer bombs will drop first (stations 6 & 1), then the central bombs (stations 5 & 2) and finally the inner bombs that are the closest to the airframe (stations 4 & 3).

In real life, the Mi-8 had a bombsight to help you drop bombs precisely. However, this feature is not implemented yet in DCS. So... yes, you will have to do it by aiming visually. Not an easy task by any stretch of the imagination.





# HOW TO DROP BOMBS

But... but... what if I am carrying other things than bombs? Good point! This is where the “Payload Profile Selector” comes in handy.

There are five profiles available, displayed in roman numerals: I, II, III, IV and V. For the type of mission you are doing, you should make sure that your loadout reflects at least one of these profiles if you want things to be easier for you. My advice to you is to load your bombs on the outer stations since the release sequence always starts from the outer stations.

For a typical mission loadout, I generally take B/G/G/G/G/B, with B being a bomb and G being a gun or rocket pod. This profile is not in the preset profile table.

Don't worry, it's not a big deal. By selecting profile II and using the bomb Electrical Release Control Box (ESBR), we will be able to drop our bombs without dumping the other pods.

Profile Loadouts Table						
Profile # / Station	6	5	4	3	2	1
I	Rocket	Rocket	Rocket	Rocket	Rocket	Rocket
II	Bomb	Bomb	Bomb	Bomb	Bomb	Bomb
III	Bomb	Bomb	Rocket	Rocket	Bomb	Bomb
IV		Bomb	Rocket	Rocket	Bomb	
V		Bomb	Bomb	Bomb	Bomb	



# HOW TO DROP BOMBS (B/G/G/G/G/B Configuration)

- 1) Turn ON weapon system breakers
- 2) Turn ON Master Arm on roof panel
- 3) Set ESRB control box to OFF (LEFT)
- 4) Select bomb station release by right clicking on the ESRB selector and choosing "1" for single bomb drop. Mode "1" will drop a single bomb from the default bomb drop sequence.
- 5) Set ESRB control box to ON (RIGHT).

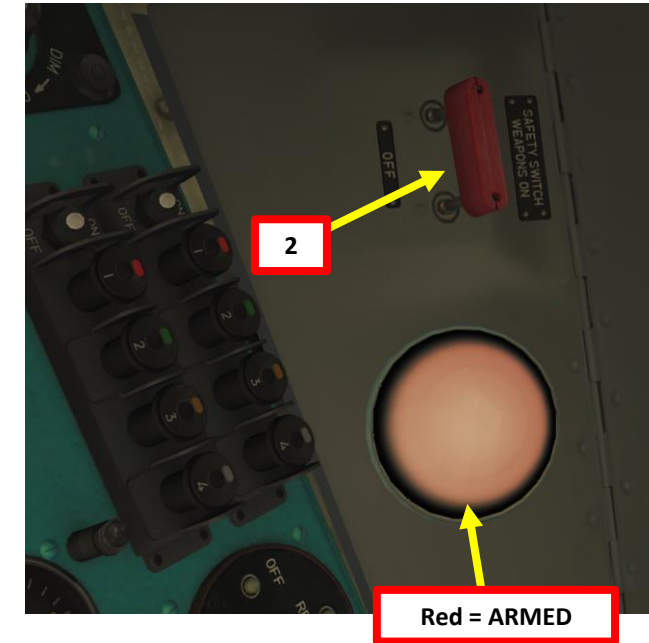
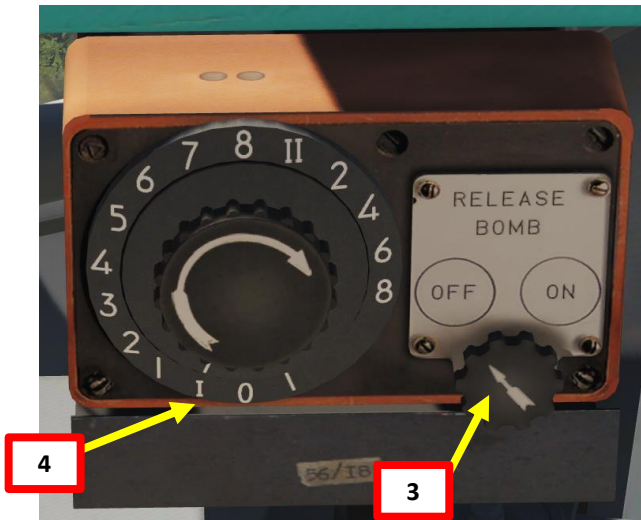
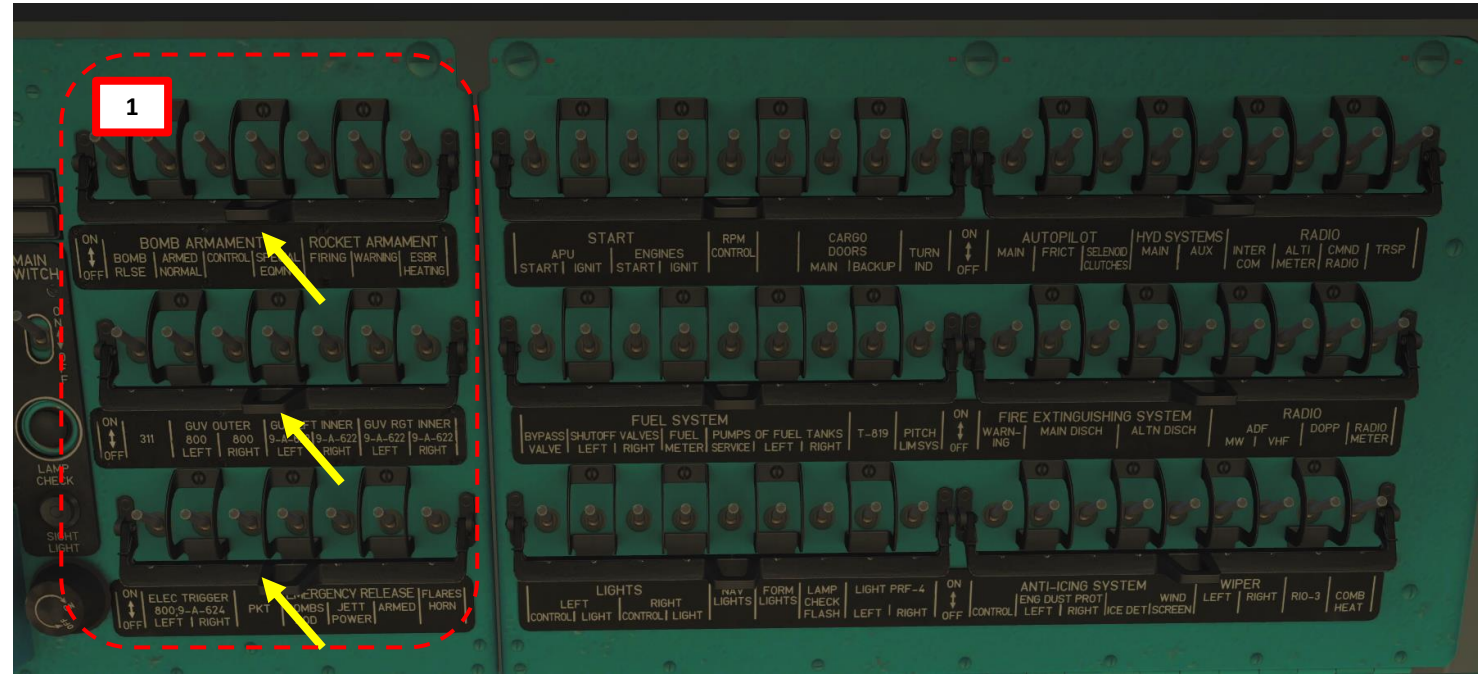



# HOW TO DROP BOMBS (B/G/G/G/G/B Configuration)

- 6) Select payload profile II
- 7) Turn Main Weapons Power ON
- 8) Bomb arming switch ON (UP).
- 9) Drop bombs using the "Release Bomb" switch (B). Do not confuse with "Weapons Release".

**DROP SEQUENCE:  
6-1-5-2-4-3**

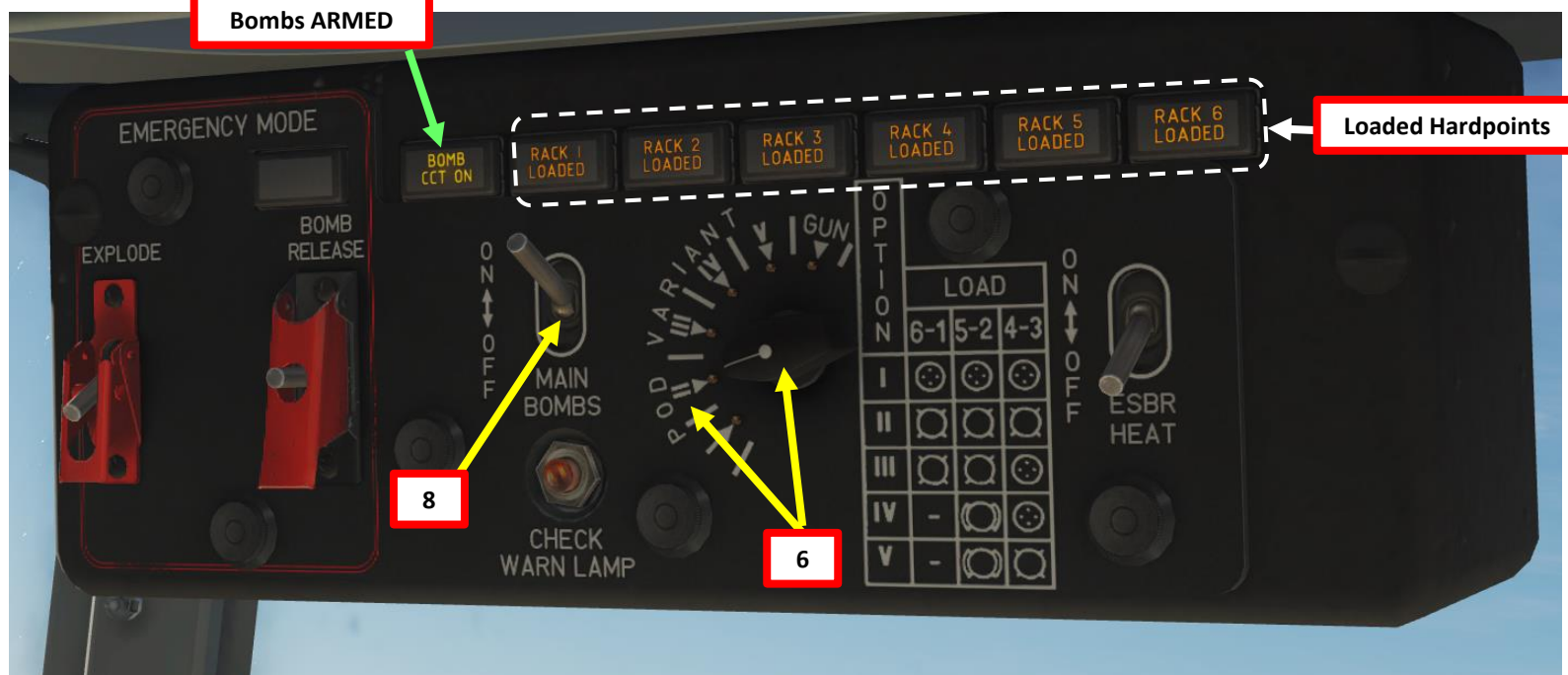
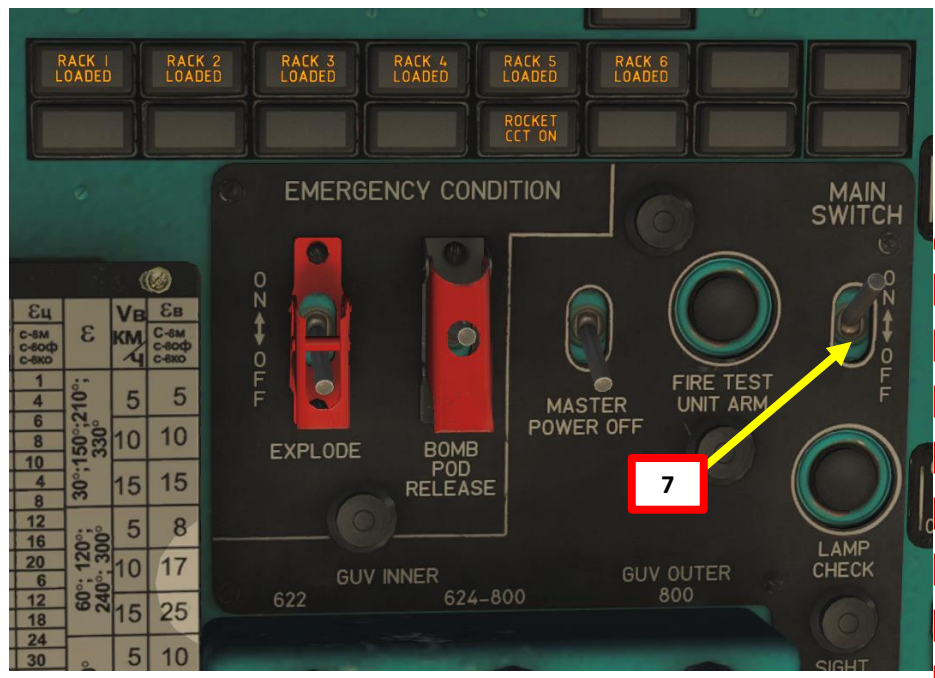

# HOW TO DROP BOMBS (B/G/G/G/G/B Configuration)



MI-8MTV2  
HIP

PART 12 – WEAPONS & COUNTERMEASURES



## HOW TO DROP BOMBS – IN CONCLUSION

There are many ways to drop bombs. You can release a bomb from any pylon if you want to, but the procedure is not instinctive and I think it confuses most players more than they help them. Rather than operate the ESRB in a complicated way for a given loadout, I would rather choose my own loadout and choose an easy way to drop bombs that is instinctive and idiot-proof.

My recommended loadout for a Mi-8 is a generally to have 2 bombs on the outer pylons, and gun pods on the central and inner pylons. If you set your ESRB bomb release mode to “1” as shown in step 4 (single bomb drop) and you know that you only have 2 bombs on your outer pylons, you just need to press the bomb release trigger 2 times to drop your 2 bombs. Once your bombs are dropped, you can simply turn OFF the bomb panel and you can forget about the risk of dropping your gun pods.

Easy as pie.

To know more about the advanced functionalities of the ESRB release modes, I suggest that you read the DCS Mi-8 manual.

DCS Mi-8 Manual:

<http://www.digitalcombatsimulator.com/en/files/1074349/>

## HOW TO AIM WITH A GUNNER

- 1) Select desired AI autopilot mode.
- 2) Select side gunner (press “4”).  
Note: Rear gunner is not selectable.
- 3) You can toggle the CREW STATUS window (AI Panel) by pressing “LWIN+H”
- 4) By default, the gun will follow where you look in trackIR. If you prefer to aim with the mouse (recommended), press “LALT+T” (TrackIR Aiming ON/OFF binding). The mouse will then take over.
- 5) Fire using the MACHINEGUN FIRE button (SPACE) available in the MI-8MTV2 GUNNER Options Control menu or your left mouse button.

## LEFT GUNNER CONTROLS

TAKE LEFT GUNNER POSITION: 4  
 SET AI ROE (RULE OF ENGAGEMENT): L\_CTRL+LWIN+4  
 SET AI FIRING BURST LENGTH: L\_SHIFT+LWIN+4  
 AI AUTOPILOT ON/OFF: RALT+A  
 SHOW GUNNER PANEL HINTS: RALT+RSHIFT+K  
 MOUSE CURSOR CLICK MODE ON/OFF: LALT+C

## REAR GUNNER CONTROLS

### (NOT SELECTABLE)

SET AI ROE (RULE OF ENGAGEMENT): L\_CTRL+5  
 SET AI FIRING BURST LENGTH: L\_SHIFT+5  
 AI AUTOPILOT ON/OFF: RALT+A  
 SHOW GUNNER PANEL HINTS: RALT+RSHIFT+K





# STORES EMERGENCY JETTISON (PILOT)

In case of emergency jettison from the pilot's seat, all stores will be jettisoned independently on store types.

- 1) Turn ON weapon system breakers
- 2) Turn ON Master Arm on roof panel
- 3) Set your Bomb Arming switch to the desired setting for bomb jettison (recommended: OFF)

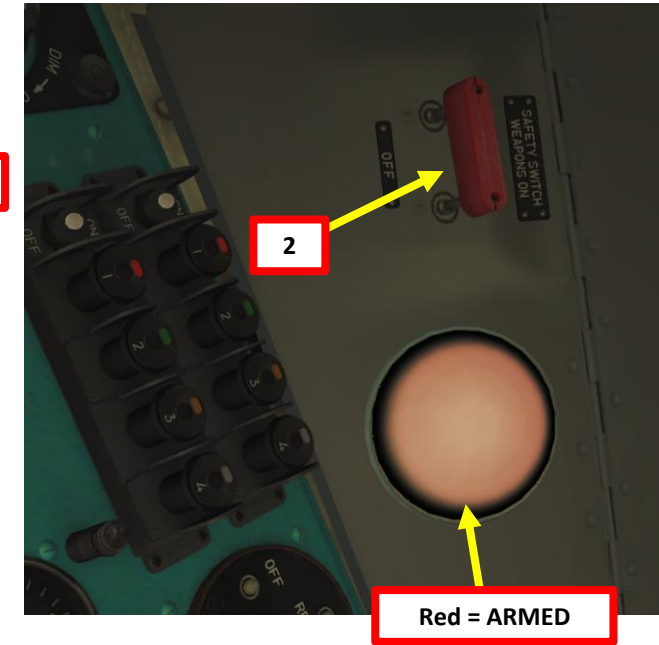
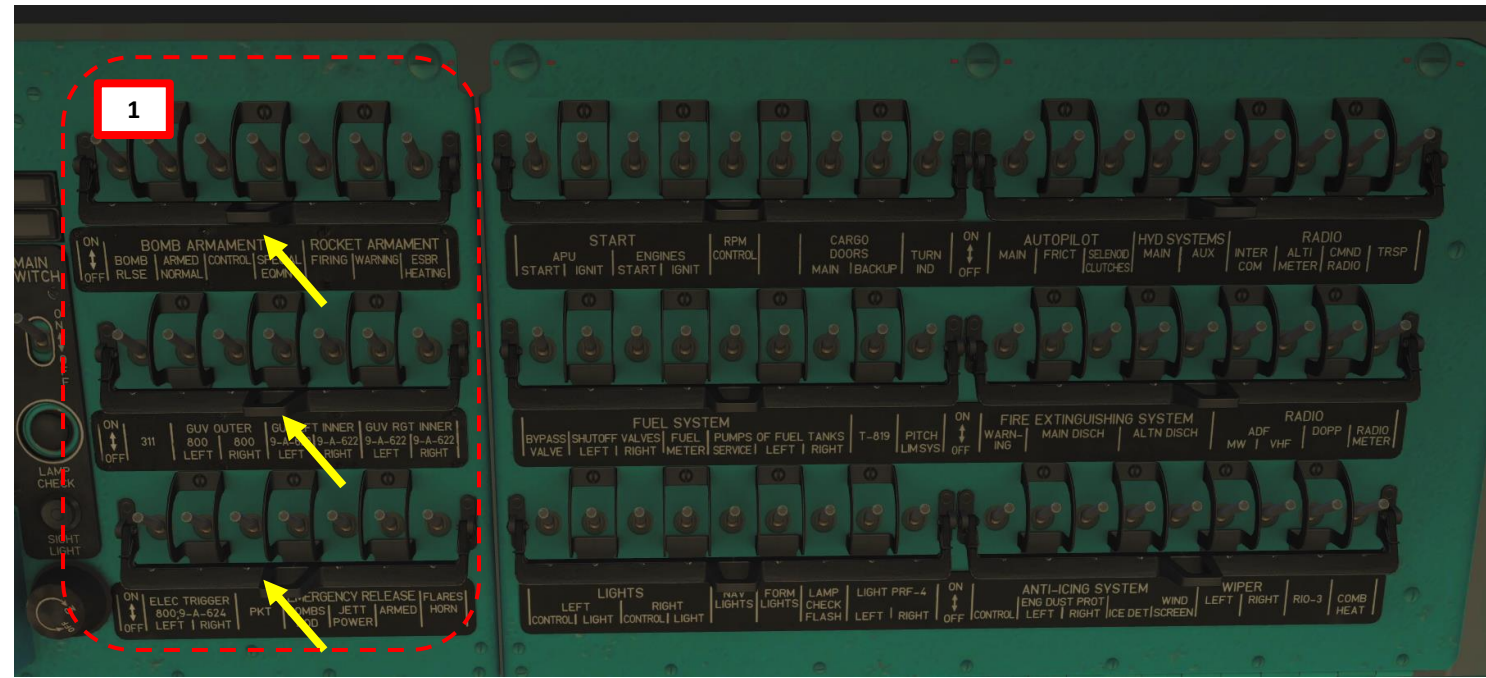

# STORES EMERGENCY JETTISON (PILOT)

- 4) Turn Main Weapons Power ON
- 5) If bombs are armed, set the Jettison “Explode” switch to ARMED (UP). If bombs are disarmed, set Jettison “Explode” switch to DISARMED (OFF).
- 6) Jettison ordnance by flipping the “Bomb Pod Release” Jettison switch to UP (ON).
- 7) Confirm that ordnance has been jettisoned properly with the annunciator lights

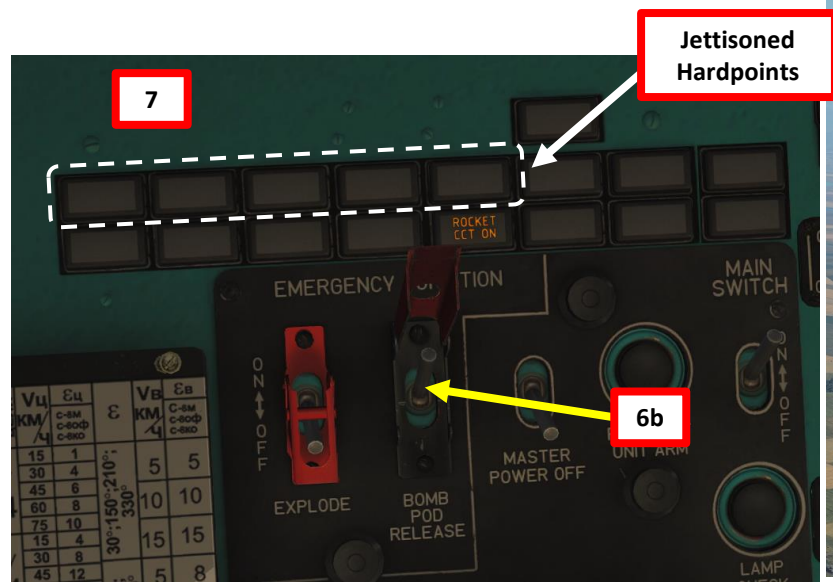
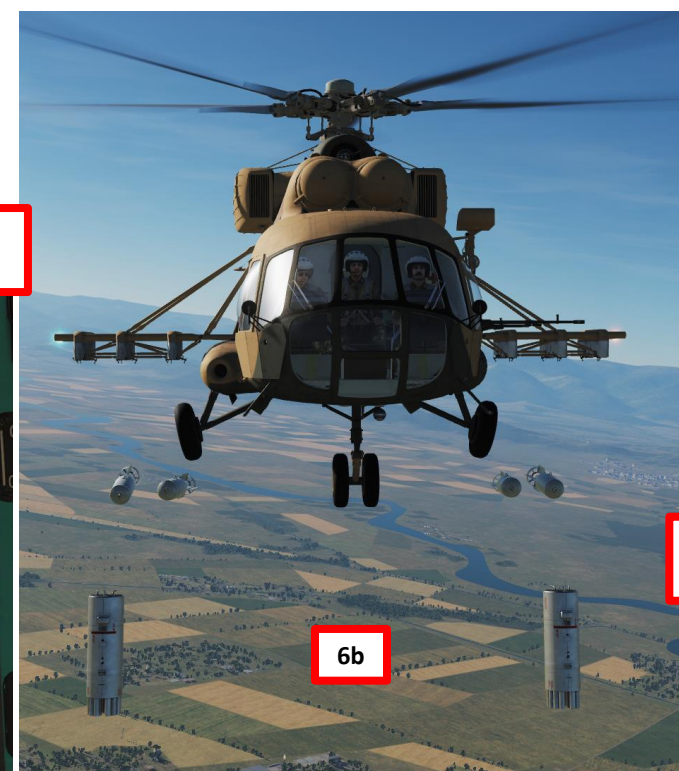
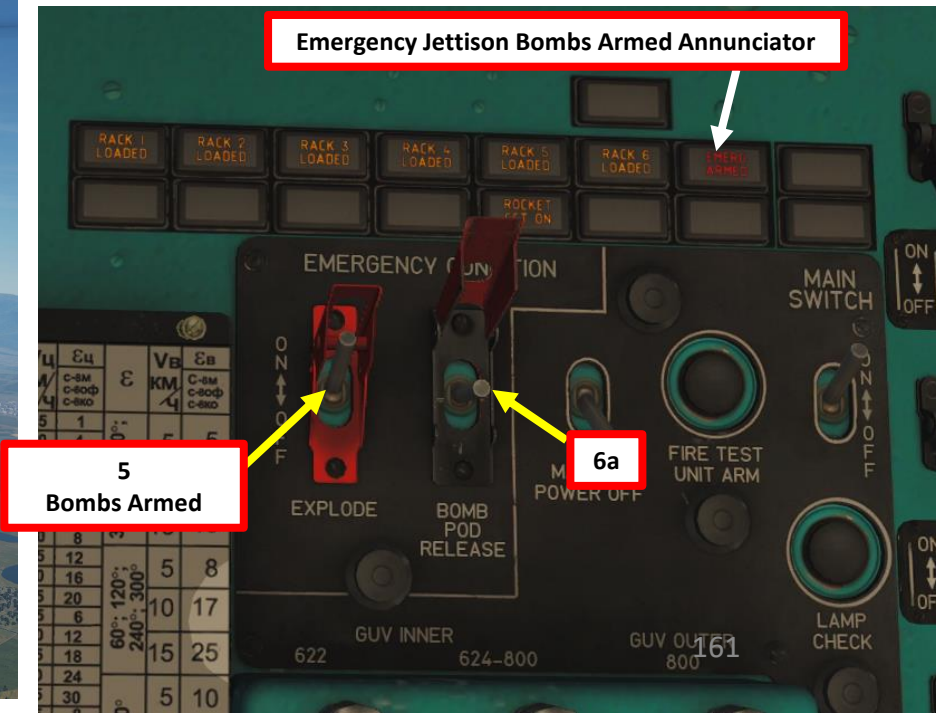
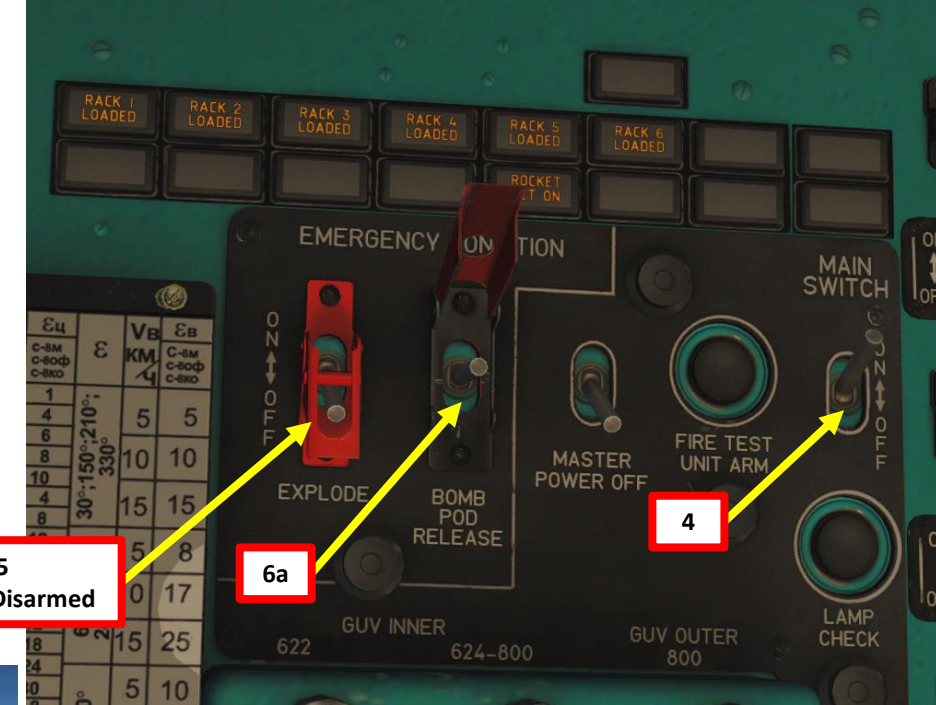



# STORES EMERGENCY JETTISON (COPILOT)

If emergency jettison is performed from the co-pilot's seat, ordnance will be dropped as per the Jettison Profile option selected.

- 1) Turn ON weapon system breakers
- 2) Turn Main Weapons Power ON
- 3) Turn ON Master Arm on roof panel
- 4) Set your Bomb Arming switch to the desired setting for bomb jettison (recommended: OFF)
- 5) Select desired Jettison Profile (in our case we will choose profile V since we just want to jettison stations 5, 2, 4 and 3)

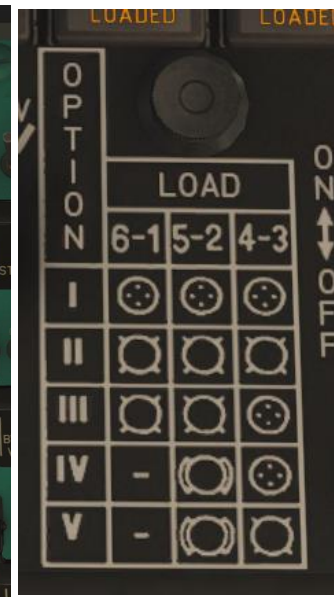
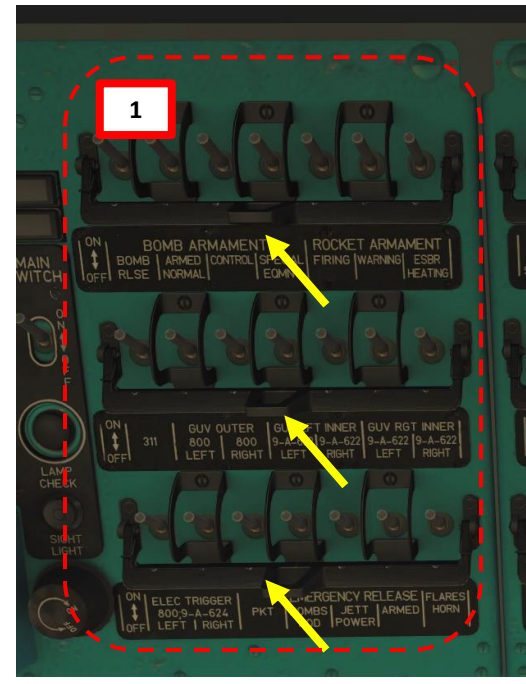

Jettison Profile	
Profile I	"all rocket launcher" – nothing will be jettisoned
Profile II	"all bombs" – jettison impulse is sent to external hardpoints 1, 6, 5, 2, 4 and 3 simultaneously
Profile III	"bombs- rocket launchers" – jettison impulse is sent to external hardpoints 1, 6, 2, and 5 simultaneously
Profile IV	"bombs- rocket launchers" – jettison impulse is sent to external hardpoints 2 and 5 simultaneously
Profile V	"all bombs" – jettison impulse is sent to external hardpoints 2, 5, 3, and 4 simultaneously

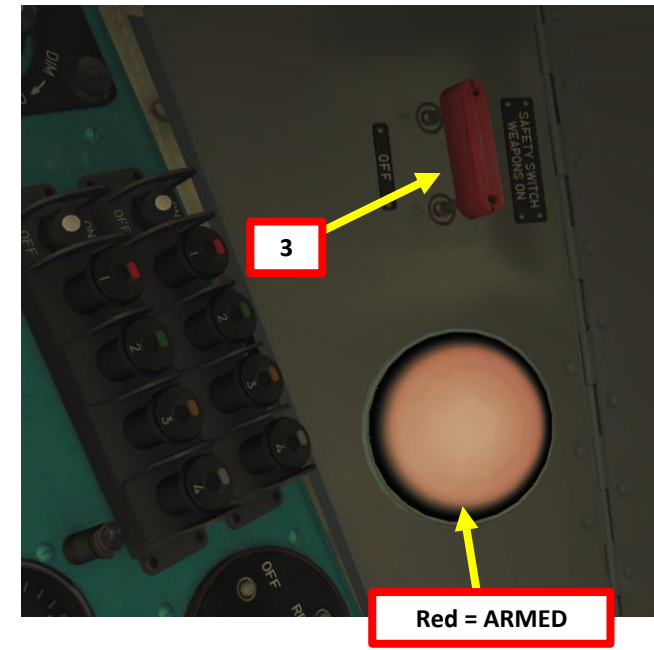
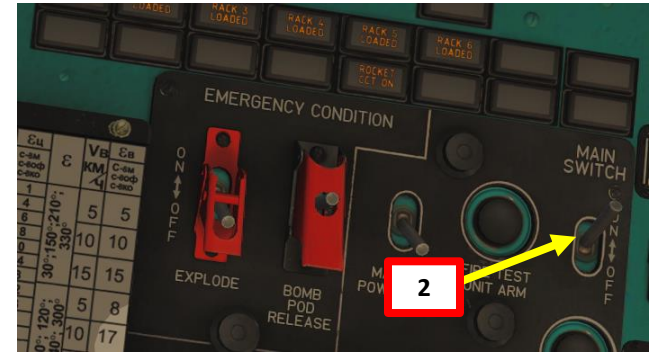

Red = ARMED

# STORES EMERGENCY JETTISON (COPILOT)

- 6) If bombs are armed, set the Jettison “Explode” switch to ARMED (UP). If bombs are disarmed, set Jettison “Explode” switch to DISARMED (OFF).
- 7) Jettison ordnance by flipping the “Bomb Pod Release” Jettison switch to UP (ON).
- 8) Confirm that ordnance has been jettisoned properly with the annunciator lights



6  
Bombs Disarmed



7a

6  
Bombs Armed



Emergency Jettison Bombs Armed Annunciator

7a

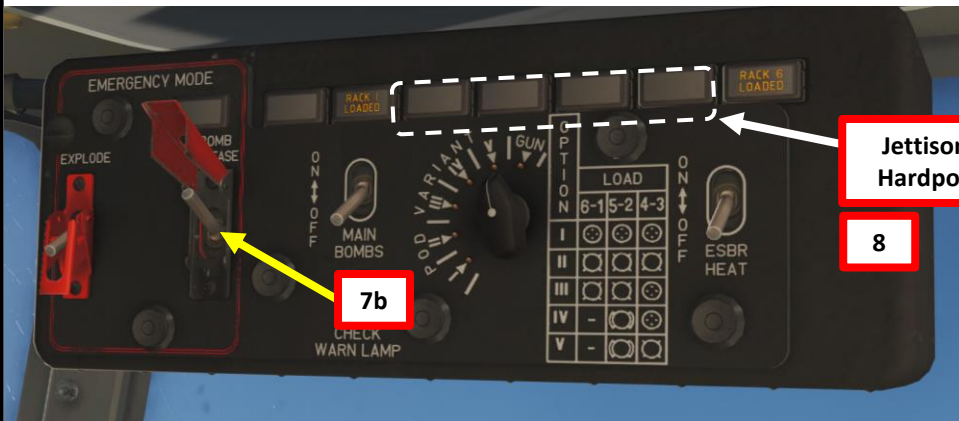

Jettisoned Hardpoints

8

7b



# COUNTERMEASURES INTRODUCTION

**Countermeasure Panel Power Switch**  
UP = ON / DOWN = OFF



**UV-26 Countermeasure Dispenser**

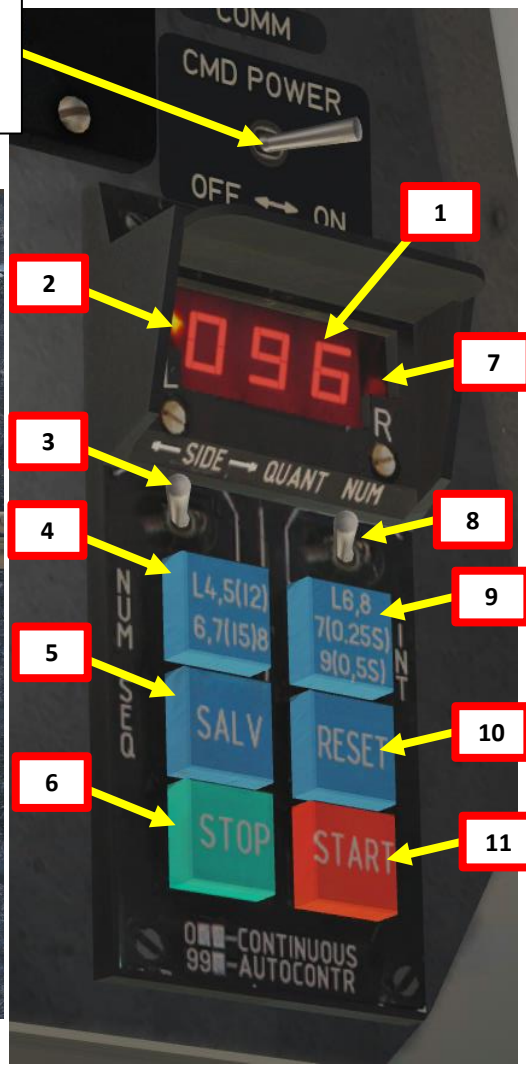

1. **Program display.** The digital read-out indicates the currently selected flare dispensing parameters. When the "НАЛИЧ-ПРОГР" (REMAIN-PROGRAM) switch is in the "НАЛИЧ" (REMAIN) position, the display shows the remaining quantity of flares (the Mi-8 can carry a maximum of 128). When in the "ПРОГР" (PROGRAM) position, the first number indicates the "СЕРИЯ" (SEQUENCES) setting, the second number indicates "ЗАЛП" (SALVO) setting, and the third number shows the setting for "ИНТЕРВАЛ" (INTERVAL). Right Saddle Tank
2. **Dispenser side lamp** – Indication that flares will be dispensed from the left dispenser
3. "БОРТ" (LFT-RGT, left/right) **Release Select** switch. This is a three position switch that can be set to the center position for release of flares from both sides; to the left for release of flares from the left side or to the right for release of flares just from the right side. Depending on the selection, the appropriate lamp(s) will be visible in the display field above.
4. "СЕРИЯ" (**SEQUENCES**) button [RShift + Insert]. Pressing this button cycles through the number of flare sequences options. The number of sequences is equal to the number of times the program will be run (except for 5 when the number of sequences is 12 and for 7 when the number of sequences is 15). When the value is set to 0, flares will be dispensed continuously.
5. "ЗАЛП" (**SALVO**) button [RCtrl + Insert]. Press this button to cycle between the number of flares to be released in a single program sequence.
6. "СТОП" (**STOP**) button [Delete]. Stops the currently running program.
7. Dispenser side lamp – Indication that flares will be dispensed from the right dispenser.
8. "НАЛИЧИЕ – ПРОГР" (**REMAIN - PROGRAM**) switch [RCTRL+ ]]. When set to "НАЛИЧИЕ" (REMAIN), the display indicates the number of flares remaining; when set to "ПРОГР" (PROGRAM), it shows the current flare program numeric code.
9. "ИНТЕРВАЛ" (**INTERVAL**) button [RAlt + Insert]. Pressing this button cycles between the time-delay between flare release settings. The delay is in seconds and is equal to the displayed number except for the cases of 7, 9 and 0, for which the intervals are 0.25, 0.5 and 0.125 seconds respectively.
10. "СБРОС ПРОГР" (**RESET**) button [RCtrl + Delete]. This button resets the programmed parameters to the default, "110".
11. "ПУСК" (**DISPENSE/DYSTY**) button [Insert]. Pressing this button executes the configured flare dispersion program.



# HOW TO DEPLOY COUNTERMEASURES

MI-8MTV2  
HIP

PART 12 – WEAPONS & COUNTERMEASURES





# HOW TO DEPLOY COUNTERMEASURES (MANUAL)

Deploying flares in manual mode is quite easy.

1. Press “2” to go in the co-pilot seat and turn ON (UP) countermeasure panel power switch
2. Press “1” to go in the pilot seat and deploy flares using the YB-26 button to pop 1 flare.

Note: You can also use the countermeasure panel to create more advanced countermeasure programs.





## HOW TO DEPLOY COUNTERMEASURES (PROGRAM)

1. Press "2" to go in the co-pilot seat and turn ON (UP) countermeasure panel power switch
2. Set desired program
  - a) Set SIDE switch as required (Middle is recommended to use both sides)
  - b) Set REMAIN – PROGRAM switch to PROGRAM (Right)
  - c) Press SEQUENCES button to cycle through the number of flares options
  - d) Press INTERVAL button to cycle between the time-delay between flare release settings.
  - e) Press SALVO button to cycle between number of flares to be release in a single program sequence.
3. Press the START button to start deploying countermeasure program.
4. To abort a program sequence, press STOP.

Program Example:

**622**: 6 sequences, 2 flares in a sequence, 2 second interval. Flares will be dispensed in pairs, one from each side or from one side only, again depending on the "BOPT" (SIDE) switch position.





# HOW TO DEPLOY SIGNAL FLARES

- 1. Set Signal Flare Control Panel Power Switches – ON (UP)
- 2. Press the desired Signal Flare Dispense Buttons

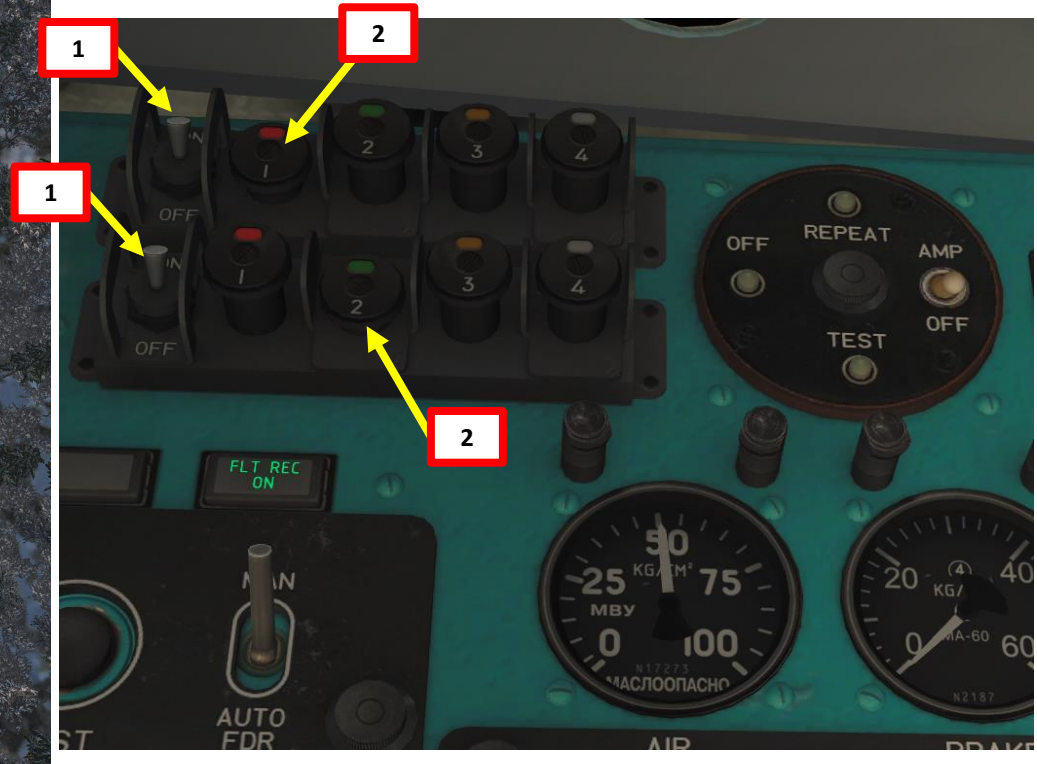
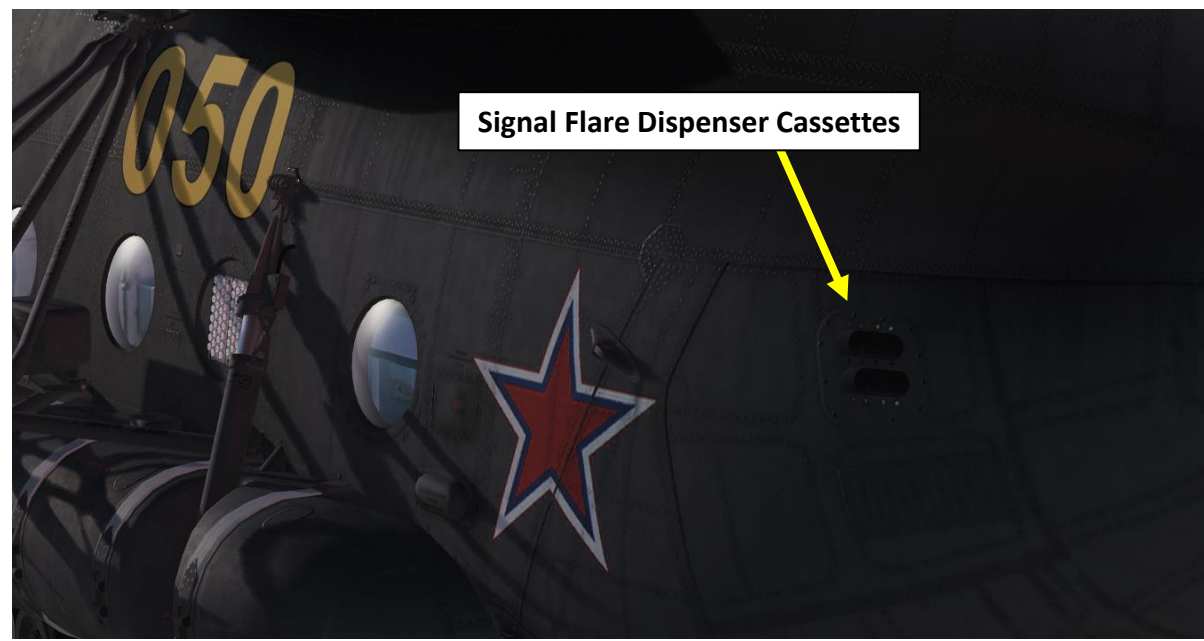



## RADIO SYSTEM OVERVIEW

You have three radios you can use.

- The VHF/UHF R-863 command radio set is used for Air-to-Air and Air-to-Ground primary communications (flight & ATC calls).
- The HF YaDRO-1A radio set is used for very long range Air-to-Air and Air-to-Ground communications.
- The LVHF (Lower Very High Frequency) R-828 radio set is used for Air-to-Air and Air-to-Ground alternate communications.
  - Note: Can also be used for ADF radio navigation
- The SPU-7 ICS (Intercom Set) panel allows you to choose which radio set you communicate on.

Most of the time, you will only be using the R-863 radio.

Radio Set	Frequency Range
R-863 VHF/UHF	100 to 149.975 MHz 220 to 399.975 MHz
YaDRO-1A HF	2 to 17.999 MHz
R-828 LVHF	20 to 59.975 MHz





# RADIO SYSTEM OVERVIEW

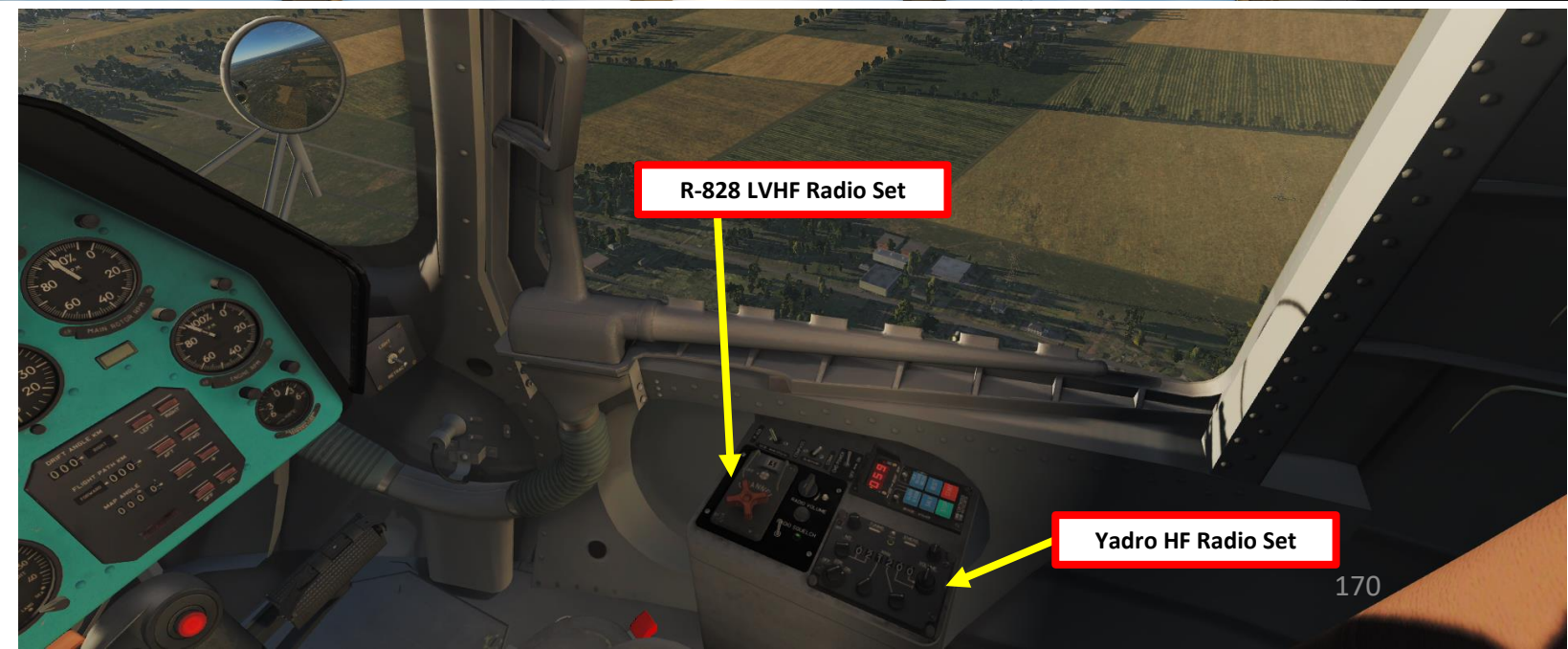
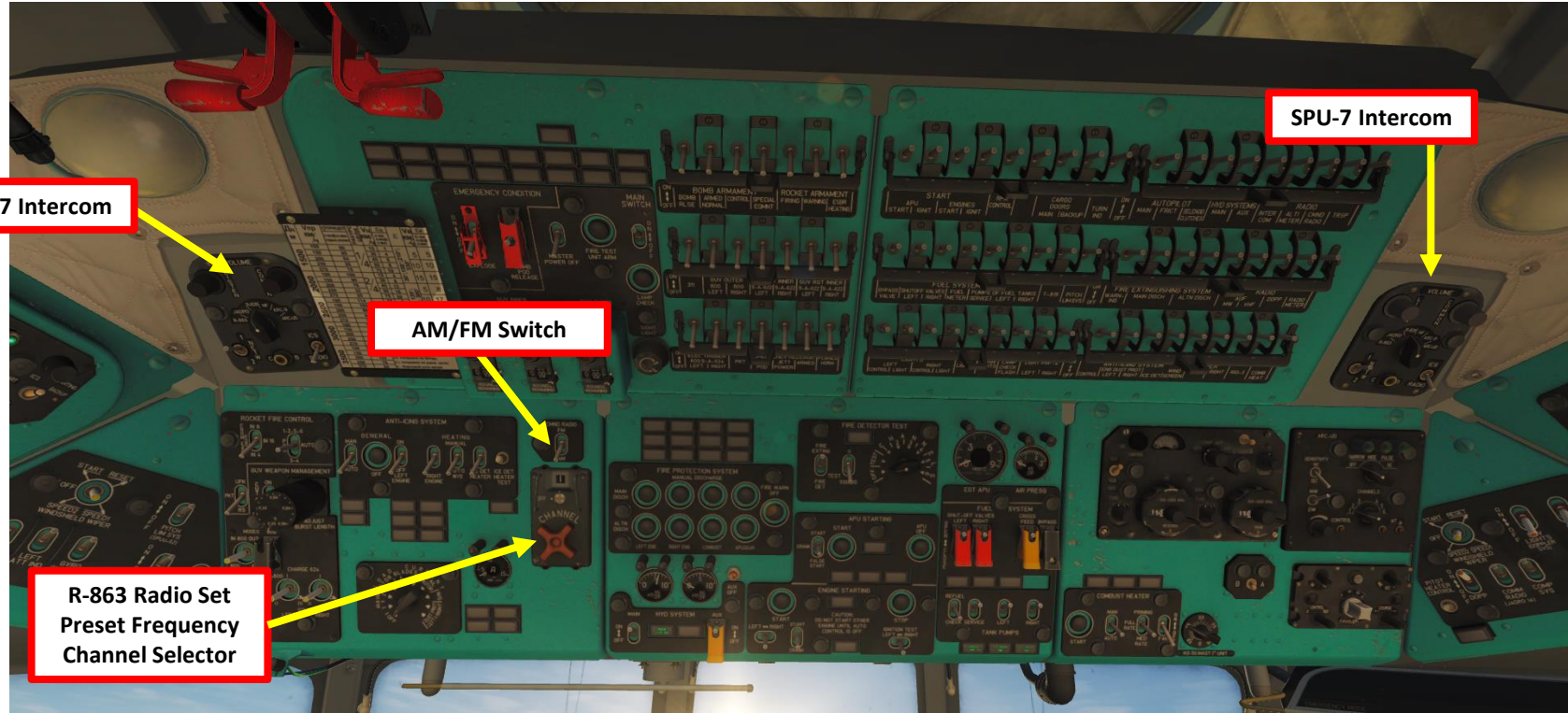



## SPU-7 ICS (Intercom Set)

This is what you use to select which radio you want to communicate on.

Note: To rearm the Mi-8 in DCS, you have to switch the lower right switch (No. 5) on the SPU-7 to the "ICS" position (UP).



Рис. 9.89. SPU-7 control panel:

1 – "ОБЩАЯ" (MASTER) and "ПРОСЛ" (MONITOR) volume control knobs to set volume of internal and external comms.; 2 – rotary selector to select source to monitor:

"УКР" (UHF) – R-863 UHF/VHF radio set

"СР" (HF) – YaDRO-1A radio set

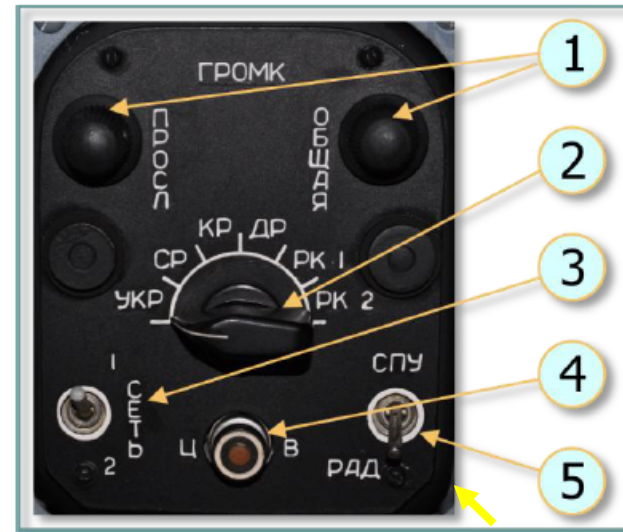
"КР" (VHF) – R-828 UHF radio set

"ДР" (SW) – not utilized

"РК 1" (ADF) – ARK-9 ADF set

"РК 2" (SAR) – ARK-UD VHF homing set

СЕТЬ 1-2 (NET 1-2) - not utilized

4 – "ЦБ" (ALL CALL) button for transmission of emergency messages. When pressed, interphone signal is transmitted to all ICS station at doubled volume level, audio warning messages are transmitted with maximum volume level; 5 - "СПУ-РАД" (ICS-RADIO) selects communication via ICS or the selected radio.



# R-863 VHF/UHF COMMAND RADIO SET

1. On ICS panel, select RADIO (DOWN).
2. On ICS panel, select R-863 radio (YKP).
3. On R-863 control panel, set Squelch to ON (UP) position for noise cancellation. If radio signal reception is not good, set to OFF (DOWN) to increase reception range.
4. On R-863 control panel, select AM or FM switch based on desired channel.
5. On central console, select PRESET (UP) or MANUAL (DOWN) Frequency control.
6. Select desired channel on either the central console or the R-863 control panel
7. Use "Radio Trigger RADIO" key binding to communicate.



### Radio Selector

- "YKP" (UHF) – R-863 UHF/VHF radio set
- "CP" (HF) – YaDRO-1A radio set
- "KP" (VHF) – R-828 LVHF radio set
- "ДР" (SW) – not utilized
- "PK 1" (ADF) – ARK-9 ADF set
- "PK 2" (SAR) – ARK-UD VHF homing set

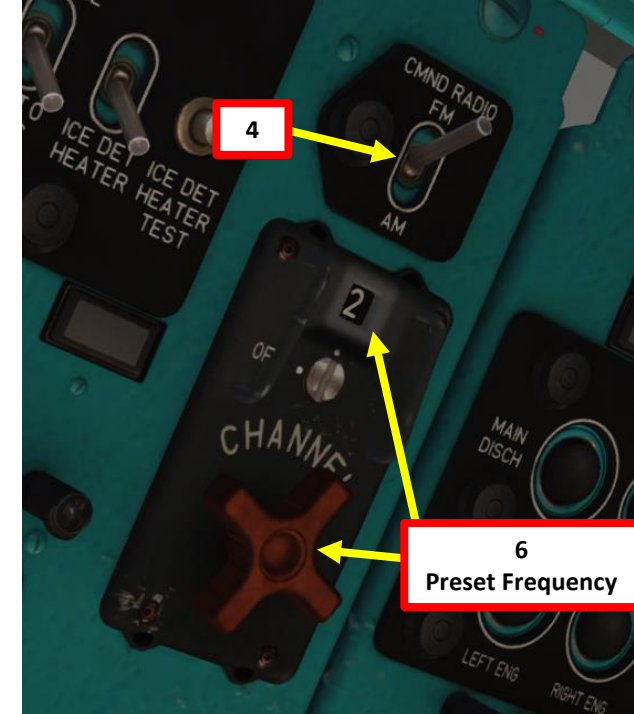
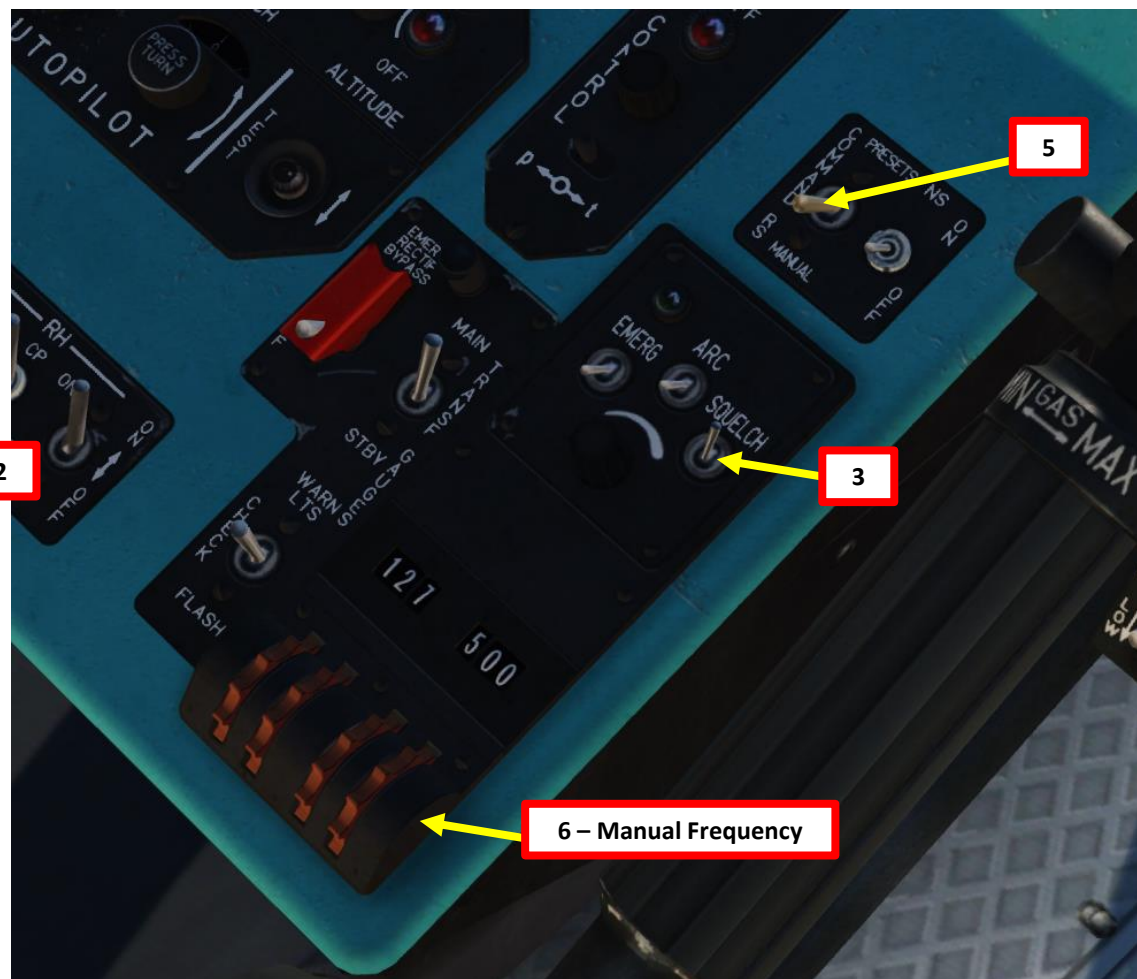

ICS (Intercommunication System)  
Push-to-Talk Radio Switch



6 – Manual Frequency

## YaDRO-1A HF RADIO SET (“JADRO” IN ENGLISH COCKPIT)

1. On ICS panel, select RADIO (DOWN).
2. On ICS panel, select YaDRO radio (CP).
3. On YaDRO control panel, set Squelch to ON (UP) position for noise cancellation. If radio signal reception is not good, set to OFF (DOWN) to increase reception range.
4. On YaDRO control panel, set power knob to ON (AM).
5. Select desired channel using the frequency selection knobs. The TUNING (HACT) light will illuminate.
6. Use “Radio Trigger RADIO” key binding to communicate.

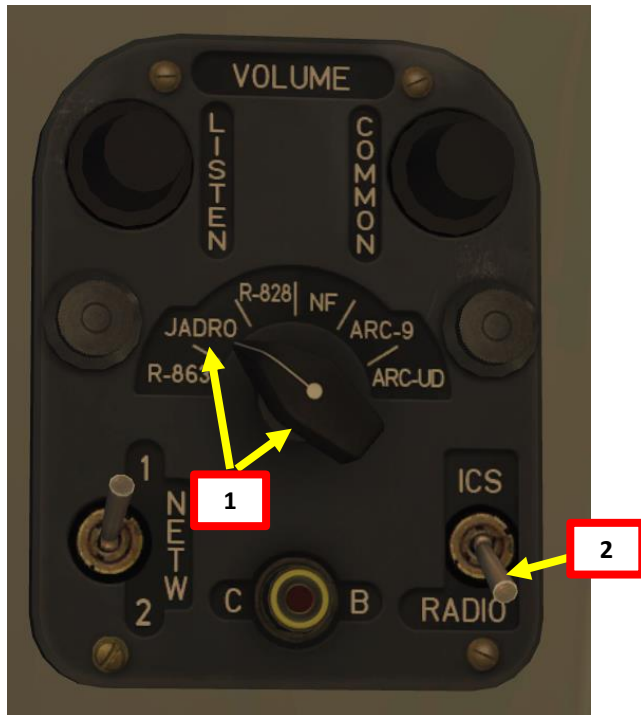

ICS (Intercommunication System)  
Push-to-Talk Radio Switch

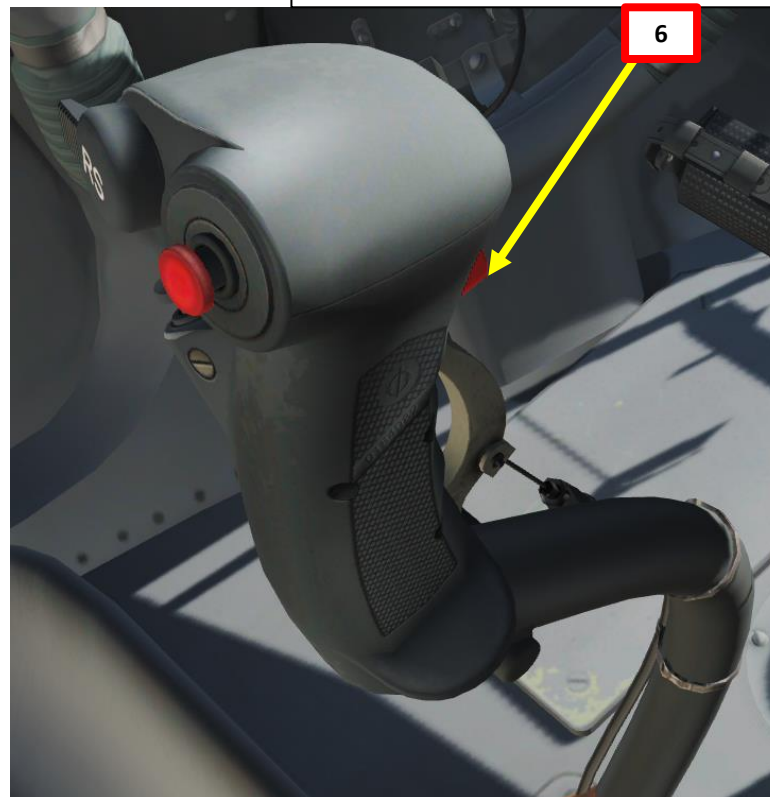

### Radio Selector

- "УКР" (UHF) – R-863 UHF/VHF radio set
- "СР" (HF) – YaDRO-1A radio set
- "КР" (VHF) – R-828 LVHF radio set
- "ДР" (SW) – not utilized
- "PK 1" (ADF) – ARK-9 ADF set
- "PK 2" (SAR) – ARK-UD VHF homing set

### YaDRO-1A control panel:



Рис. 9.93. YaDRO-1A control panel:

1 – “ПШ” (SQUELCH) knob for incremental control of the noise reduction circuit; 2 – “HACT” (TUNING) light to indicate that the radio set is tuning; 3 – “КОНТРОЛЬ” (TEST) button and light to activate and indicate progress of the radio set self-test; 4 – “АВАР” (EMERG) light to indicate the radio set is in emergency status; 5 – “ГРОМКО” (VOLUME) control knob; 6 – four knobs for frequency setting; 7 – three position selector: “ВЫКЛ” (OFF) - radio set of switched off, “ОМ” (SSD), “АМ” (AM) - selection of operating mode.





## R-828 LVHF RADIO SET

1. On ICS panel, select RADIO (DOWN).
2. On ICS panel, select R-828 radio (KP).
3. On R-828 control panel, set power knob to ON (FWD).
4. On R-828 control panel, set COMPASS/COMM switch to COMM (AFT).
5. On R-828 control panel, set Squelch to OFF (DOWN) position.
6. On R-828 control panel, select desired preset channel.
7. On R-828 control panel, press Automatic Gain Control TUNE button (ACY/ACG). TUNING (HACTP) light will illuminate once radio is set.
8. Use "Radio Trigger RADIO" key binding to communicate.

R-828			
Channel 1	< > 21.5	MHz	FM
Channel 2	< > 25.7	MHz	FM
Channel 3	< > 27	MHz	FM
Channel 4	< > 28	MHz	FM
Channel 5	< > 30	MHz	FM
Channel 6	< > 32	MHz	FM
Channel 7	< > 40	MHz	FM
Channel 8	< > 50	MHz	FM
Channel 9	< > 55.5	MHz	FM
Channel 10	< > 59.9	MHz	FM



### Radio Selector

- "УР" (UHF) – R-863 UHF/VHF radio set
- "СР" (HF) – YaDRO-1A radio set
- "КР" (VHF) – R-828 LVHF radio set
- "ДР" (SW) – not utilized
- "PK 1" (ADF) – ARK-9 ADF set
- "PK 2" (SAR) – ARK-UD VHF homing set

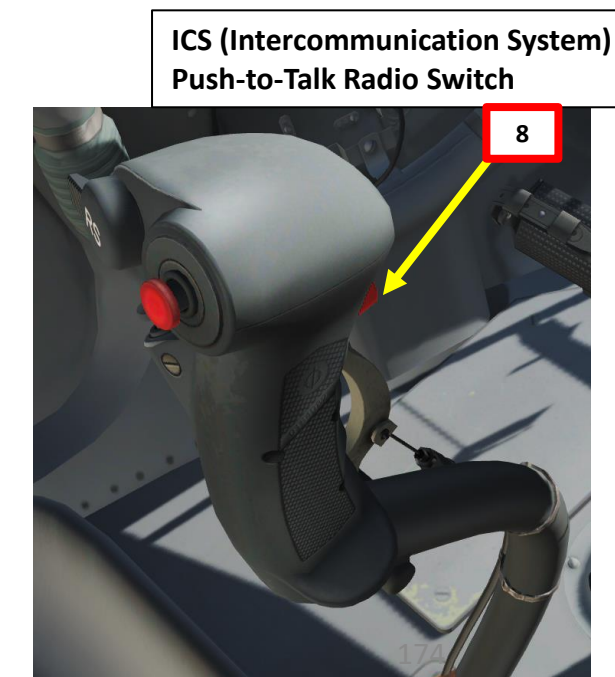
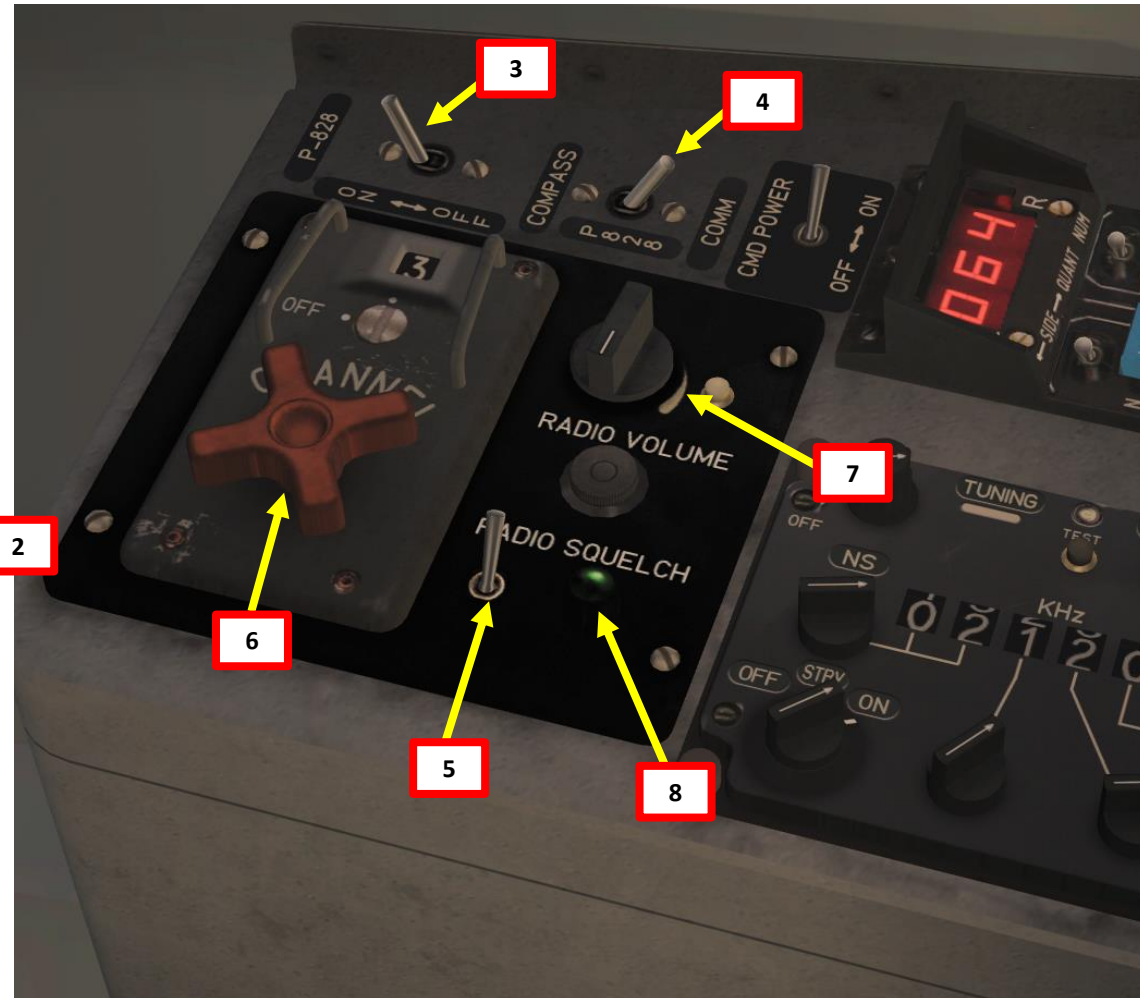

ICS (Intercommunication System)  
Push-to-Talk Radio Switch

## UNDERSTANDING ADF & NDB

Navigation is an extensive subject. You can check chapter 15 of FAA manual for more details on navigation.

LINK: [http://www.faa.gov/regulations\\_policies/handbooks\\_manuals/aviation/pilot\\_handbook/media/PHAK%20-%20Chapter%2015.pdf](http://www.faa.gov/regulations_policies/handbooks_manuals/aviation/pilot_handbook/media/PHAK%20-%20Chapter%2015.pdf)

- “NDB” is what we call a non-directional beacon. It transmits radio waves on a certain frequency on long distances. These waves are read by an ADF (automatic direction finder). NDBs are typically used for radio navigation.
- “VOR” is what we call a VHF Omnidirectional Range system. It transmits radio waves on a certain frequency. These waves are read by a VOR receiver. VOR systems, just like NDBs, can be used for radio navigation.
- NDB and VOR are used just like lighthouses were used to guide ships. This way, air corridors and airways are created to help control an increasingly crowded sky.
- The Mi-8 can navigate using the following equipment:
  - **ARK-9 ADF radio set:** you can track NDB (non-directional beacons), which are scattered throughout the map. The ADF will give you a direction to follow, but not a range.
  - **ARK-UD VHF radio set:** Emergency radio navigation system used for search and rescue. Useful for units that transmit emergency signal on VHF frequency.
  - **ARK-UD and R-828 UHF/AM radio set:** Emergency radio navigation system used for search and rescue. Useful for units that transmit emergency signal on UHF/AM frequency.
  - **DISS-15 Doppler Navigation System:** Navigation system to help you maintain a heading (useful to counter the effects of wind drift). Used for leg navigation.



# ARK-9 ADF – NDB NAVIGATION: HOW TO FIND NDB STATIONS?

Lino\_Germany created a **wonderful** HD map containing all NDB stations and VOR/ILS stations scattered throughout the map. Use this to know the NDB and VOR channel frequencies you need to set.

LINK: <https://drive.google.com/open?id=0B-uSpZROuEd3YWJBUmZTazBGajQ&authuser=0>

In the following example, we will take off from Batumi and navigate towards NDB 870, and then we will turn towards NDB 490.

**2-I / 1**  
Russian ARC radio station with related morse code and MiG-21Bis sector and channel parameters.

**682**  
NDB (Non Directional Beacon) with corresponding frequency in kHz and morse code.

**761**  
Combination of NDB and inner or outer marker. NDB with corresponding frequency in kHz and morse code.

**110.30**  
**126°**  
ILS (Instrument Landing System) with corresponding frequency in MHz, direction of the runway and morse code.

**113.60**  
VOR (VHF Omnidirectional Radio Range) with corresponding frequency in Mhz and morse code.

**67x**  
TACAN (Tactical Air Navigation) with corresponding channel and morse code.

**1**  
RSBN (VOR) and PRMG (ILS) Channel with corresponding morse code.

*Lino\_Germany's*  
**DCS BEACON MAP**  
Version 1.42

Airport Name	Airport ID
KRYMSK	4
ATC Modern Aircraft	
124.00	
253.00	39.0
ATC 2nd /3rd Generation Fighter	
F-86F 9	MI-109 K-4 Δ
MI-21Bis 9	P-51D A
ATC WW II Aircraft	
MI-15Bis 156	Fw-190 OP 1
Cockpit Wave Number / Radio Channel	

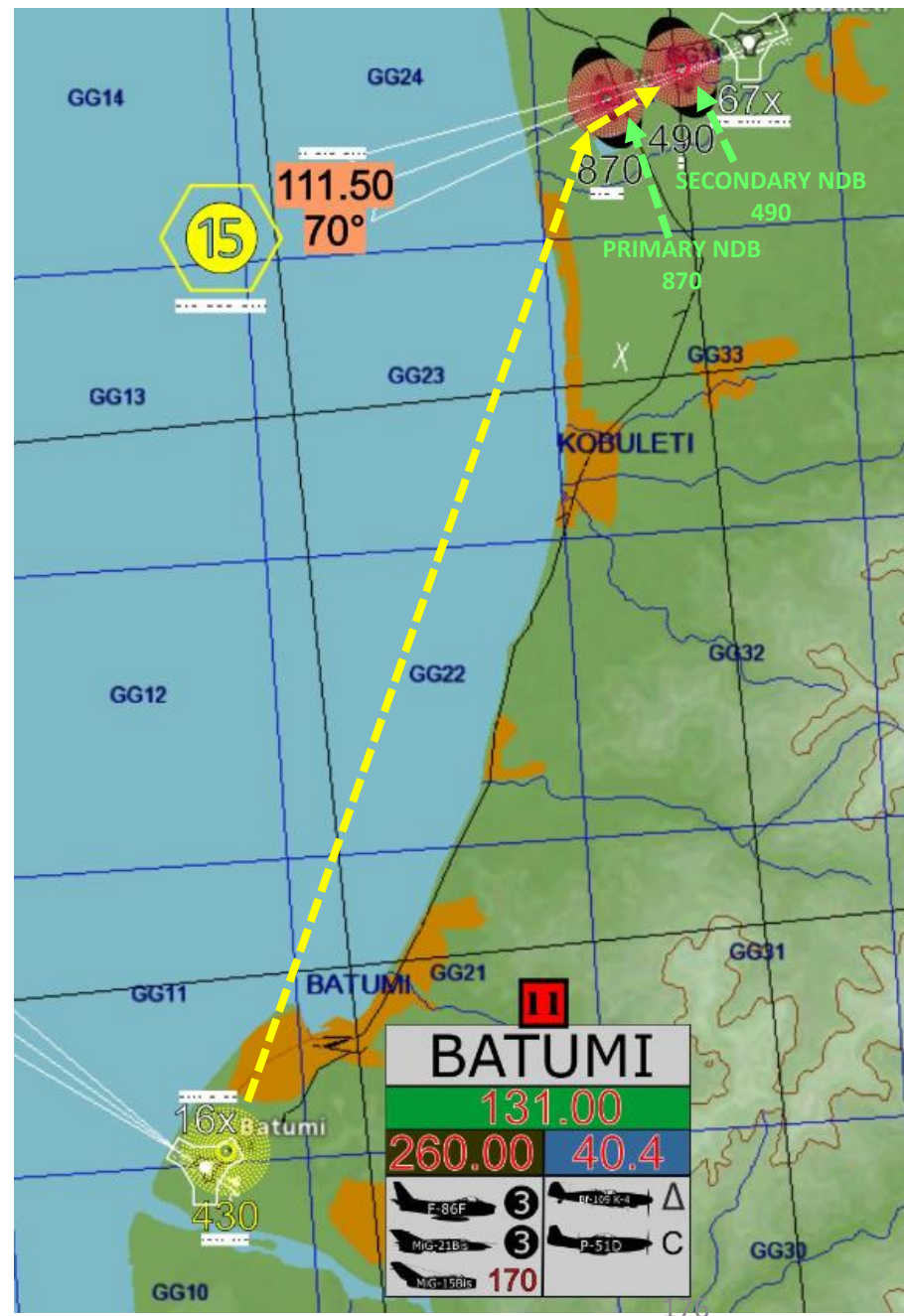
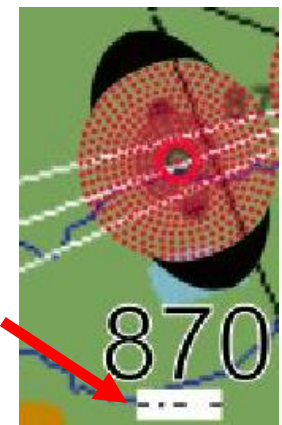

# ARK-9 ADF – NDB NAVIGATION TUTORIAL

1. Select Co-Pilot seat by pressing “2”
2. On ICS-RADIO panel, set radio mode to PK1 (ARK-9).
3. Set ARK-9 mode to COMP (Compass)
4. Set Frequency for first NDB (870) using the three rotaries for primary NDB. Fine tune in order to get a good signal strength.
5. Set Frequency for second NDB (490) using the three rotaries for secondary NDB. Fine tune in order to get a good signal strength.
6. Select Primary (LEFT) NDB to make the ADF track the primary NDB or Secondary (RIGHT) to track the Secondary NDB.
7. Select Pilot by pressing “1” and set HSI mode to “CB” (ARK-9)
8. Align white needle with white triangle and you will be heading towards the selected NDB.

In this example, we will be tracking a primary NDB (freq. 870) and then track a secondary NDB (freq. 490). Once you have set up both your frequencies, you can easily switch ADF tracking between your primary and secondary NDB using the switch mentioned at step 6.

**Navigation Tutorial by SlocketSeven**  
<https://www.youtube.com/watch?v=x9I6xi1XVrQ>

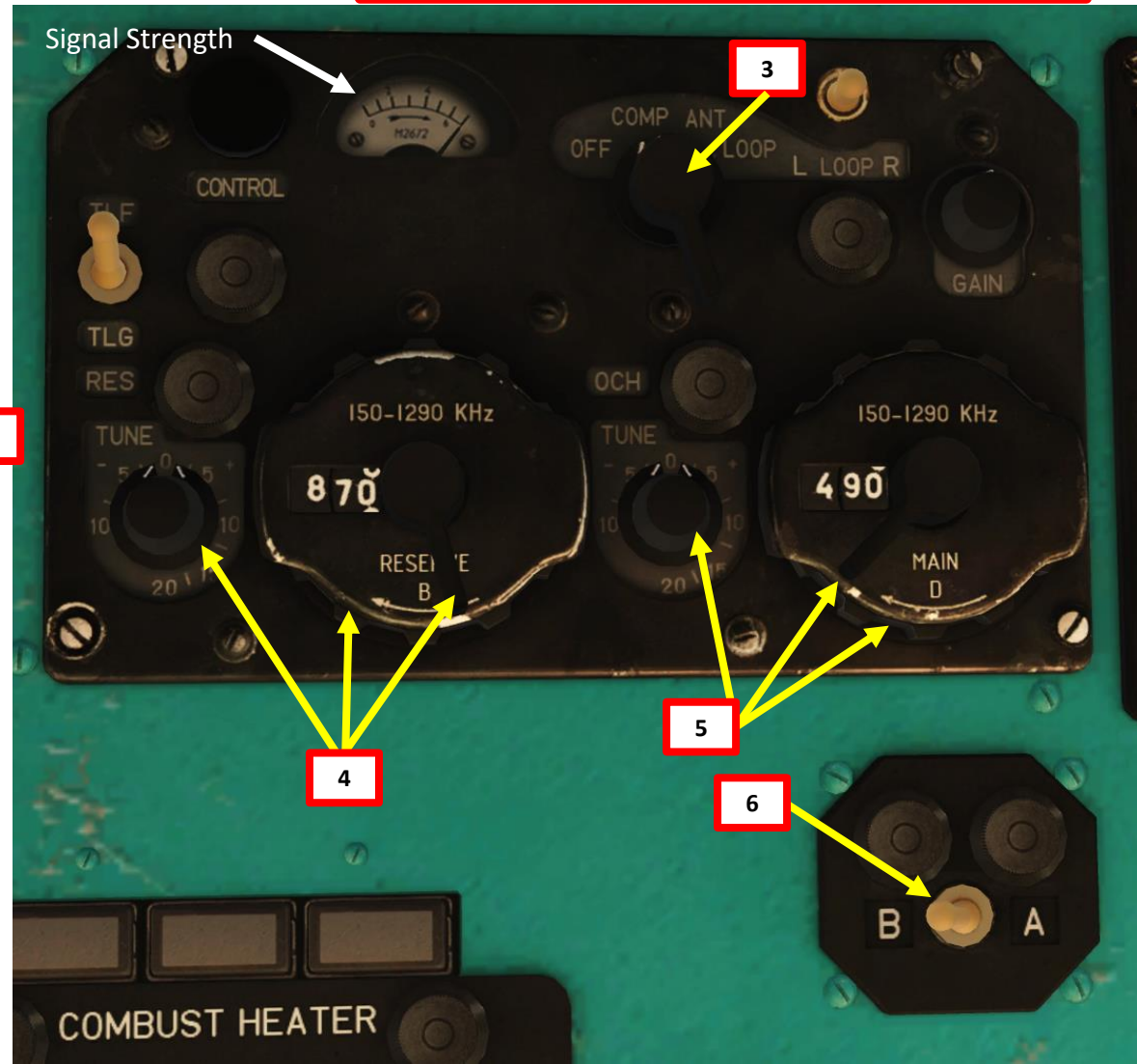
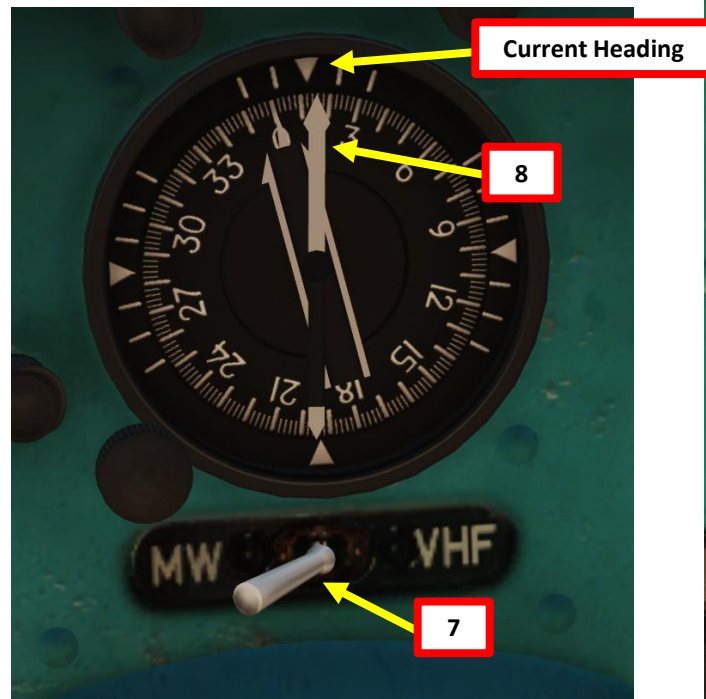



# ARK-9 ADF - NDB NAVIGATION TUTORIAL



## ARK-UD HOMING – SEARCH AND RESCUE

The ARK-UD is an emergency radio navigation system used for search and rescue. A ground unit on the ground can broadcast on an emergency frequency, and the ARK-UD system can pick up the signal and orient the pilot to it using the HSI (Horizontal Situation Indicator), which is also used for ADF (Automated Direction Finder) radio compass navigation. This system can be used in tandem with the R-828 radio system.

The ARK-UD can be used for either of the following frequencies:

- **VHF (AM)** – Preset to 6 frequencies of the ARK-UD radio
- **VHF (FM)** – Preset to 10 frequencies of the R-828 radio
- **UHF (AM)** – Preset to 243.0 MHz (ARK-UD radio)

The available frequencies for the R-828 radio are preset and appropriate frequencies from broadcasting units need to be set in the mission editor accordingly.

The UHF AM and VHF AM radio frequencies for the ARK-UD are fixed and currently cannot be configured in the mission editor.



ARK-UD RADIO CHANNELS & FREQUENCIES		
BAND	FREQUENCY (MHz)	PRESET CHANNEL
VHF (AM)	114.166	1
VHF (AM)	114.333	2
VHF (AM)	114.583	3
VHF (AM)	121.5	4
VHF (AM)	123.1	5
VHF (AM)	124.1	6
UHF (AM)	243.0	N/A

Radio Navigation Tutorial by Deephack

<https://www.youtube.com/watch?v=gLCC-tGaDRY>

**HELICOPTER GROUP**

NAME: Rotary-2

CONDITION: % < > 100

COUNTRY: Russia **COMBAT**

TASK: Transport

UNIT: < > 1 OF < > 1

TYPE: Mi-8MTV2

SKILL: Player

PILOT: Rotary-2-1

TAIL #: 19

RADIO:  FREQUENCY: 127.5 MHz AM

CALLSIGN: 104

HIDDEN ON MAP

HIDDEN ON PLANNER

HIDDEN ON MFD  LATE ACTIVATION

---

Channel	Frequency	Mode
Channel 7	< > 141 MHz	AM
Channel 8	< > 128 MHz	AM
Channel 9	< > 126 MHz	AM
Channel 10	< > 133 MHz	AM
Channel 11	< > 130 MHz	AM
Channel 12	< > 129 MHz	AM
Channel 13	< > 123 MHz	AM
Channel 14	< > 131 MHz	AM
Channel 15	< > 134 MHz	AM
Channel 16	< > 132 MHz	AM
Channel 17	< > 138 MHz	AM
Channel 18	< > 122 MHz	AM
Channel 19	< > 124 MHz	AM
Channel 20	< > 137 MHz	AM

---

**R-828**

Channel 1	< > 21.5 MHz	FM
Channel 2	< > 25.7 MHz	FM
Channel 3	< > 27 MHz	FM
Channel 4	< > 28 MHz	FM
Channel 5	< > 30 MHz	FM
Channel 6	< > 32 MHz	FM
Channel 7	< > 40 MHz	FM
Channel 8	< > 50 MHz	FM
Channel 9	< > 55.5 MHz	FM
Channel 10	< > 59.9 MHz	FM



# ARK-UD HOMING – SEARCH AND RESCUE



R-828 LVHF Radio Set  
FM Transceiver Set

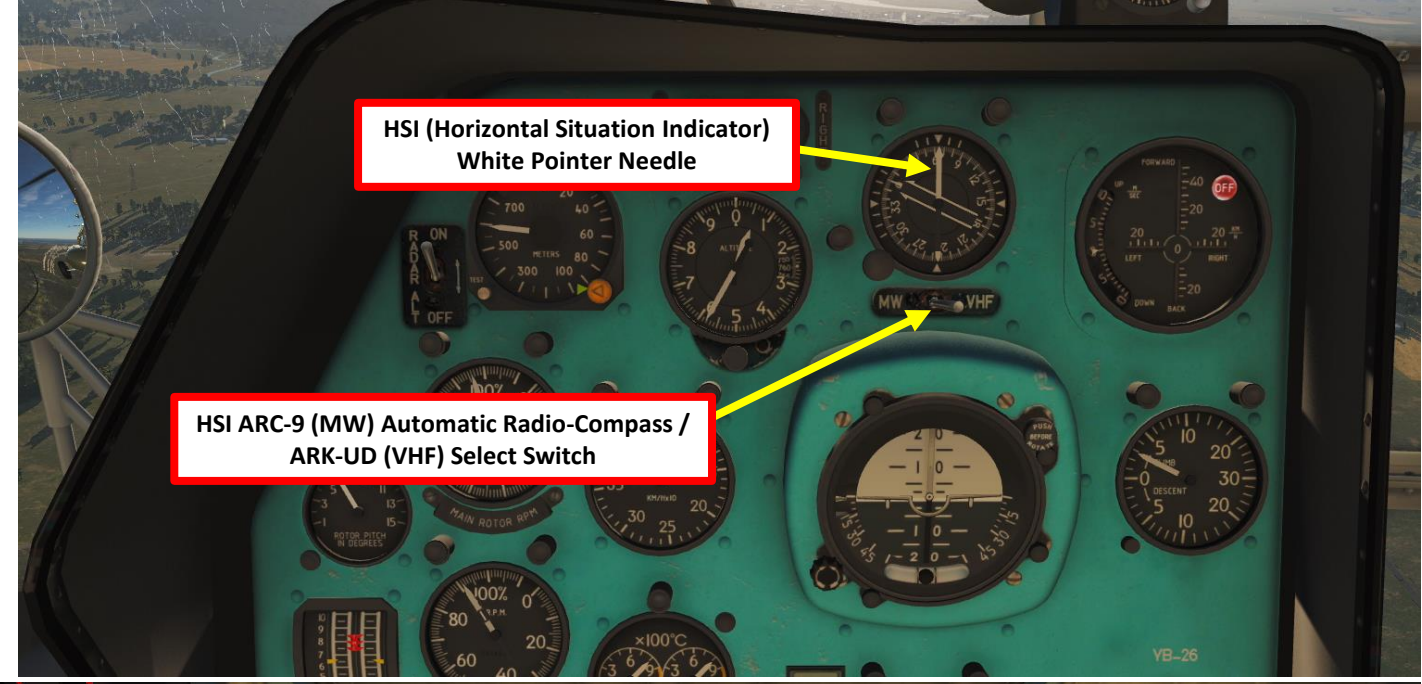

HSI (Horizontal Situation Indicator)  
White Pointer Needle

HSI ARC-9 (MW) Automatic Radio-Compass /  
ARK-UD (VHF) Select Switch

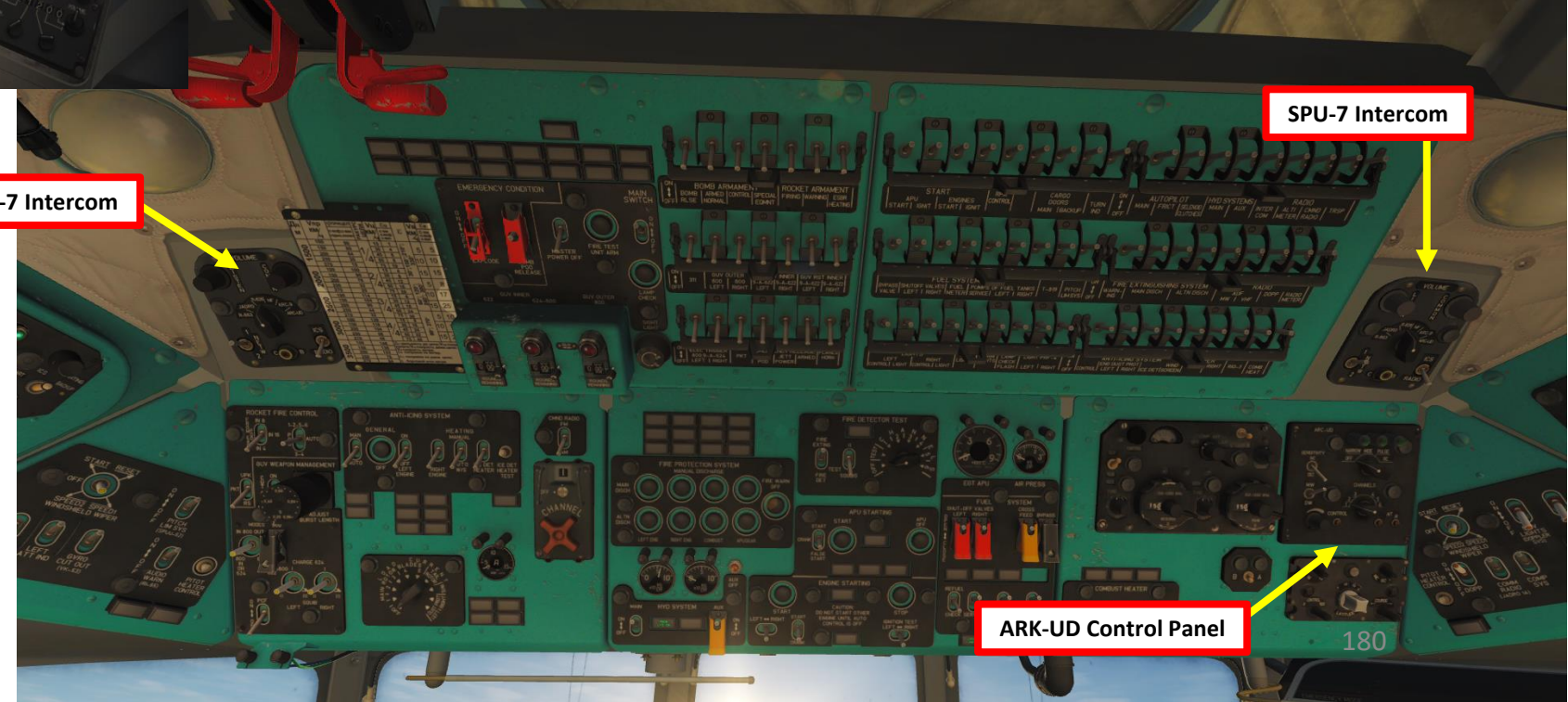

SPU-7 Intercom

SPU-7 Intercom

ARK-UD Control Panel

## ARK-UD UHF AM HOMING – SEARCH AND RESCUE

NOTE: THIS METHOD IS USED IF YOU ARE TRACKING A GROUND UNIT TRANSMITTING ON A UHF AM FREQUENCY.

The ARK-UD radio is primarily a Search & Rescue radio system that is meant to home on standard emergency frequencies (like an ELT, Emergency Locator Transmitter). The ARK-UD system can home on the ELT transmission emitter, but the frequency has to correspond to the preset frequency of 243.000 MHz. In this case, we will simulate a Search and Rescue mission to recover a crashed Mi-8 helicopter with its ELT transmitting on a **UHF AM frequency of 243.000 MHz**. We will first need to set up a mission with a unit that transmits a signal on this specific UHF AM frequency.

1. Create Unit that will transmit the distress signal
2. In ADVANCED (WAYPOINT ACTIONS) of Waypoint 0
  - I. Click on ADD
    - a) Select Type - PERFORM COMMAND
    - b) Select ACTION – SET FREQUENCY
    - c) Set Frequency to a valid frequency (243 MHz)
    - d) Select AM Band
    - e) Select Power (i.e. 100 W)
  - II. Click on ADD
    - a) Select Type - PERFORM COMMAND
    - b) Select ACTION – TRANSMIT MESSAGE
    - c) Select a valid .wav or .ogg audio file with the ELT signal. Add subtitles if desired.
    - d) Select LOOP

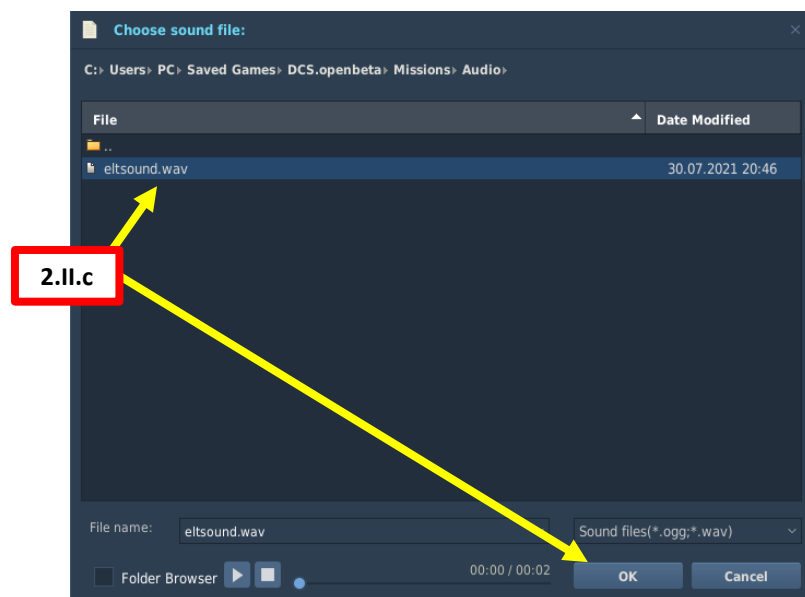



# ARK-UD UHF AM HOMING – SEARCH AND RESCUE

NOTE: THIS METHOD IS USED IF YOU ARE TRACKING A GROUND UNIT TRANSMITTING ON A UHF AM FREQUENCY.

1. Check mission briefing to know what is the approximate area to search.
2. Set ARK-UD mode to NARROW (УП).
3. Set ARK-UD preset channel on any channel (It will not matter since we use a UHF/AM frequency for this example. The ARK-UD preset channels with this selector are reserved for VHF/AM frequencies.).
4. Set ARK-UD frequency to appropriate band. For this example we will use UHF/AM (ДЦБ), which is DOWN (DW).
  - VHF (УКВ) – UP POSITION for VHF preset channels (“MW” in English cockpit)
  - UHF/AM (ДЦБ) – DOWN POSITION for UHF/AM preset channels (“DW” in English cockpit)
5. Set ICS/RADIO selector to “RADIO” (DOWN)
6. Select ARK-UD radio (PK2).
7. Green light on ARK-UD panel will be lit once signal is picked up.
8. On your HSI, select ARK-UD VHF (УКВ) mode (switch to the right).
9. Follow the white needle on the HSI (Horizontal Situation Indicator) to get to the target.

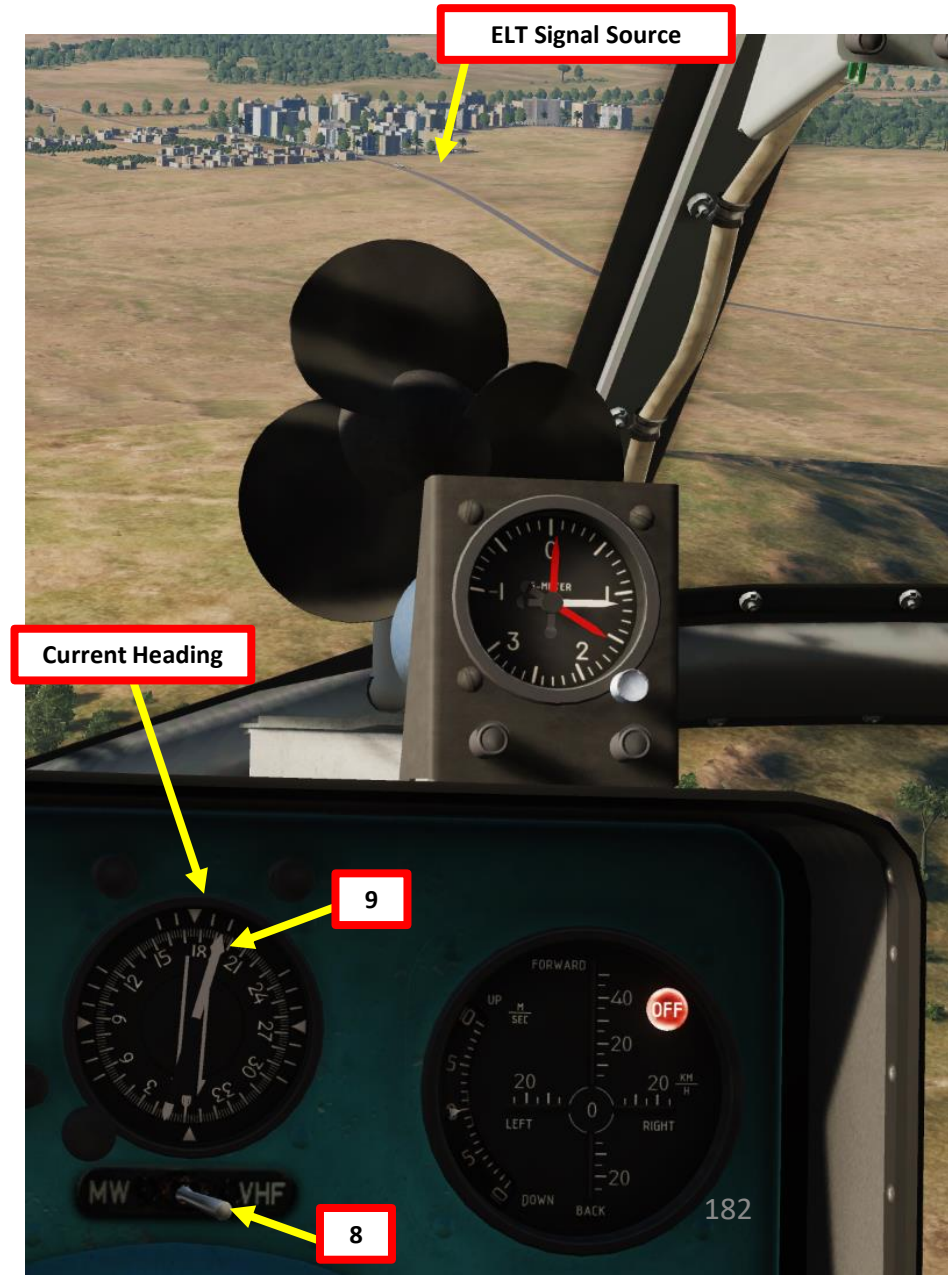
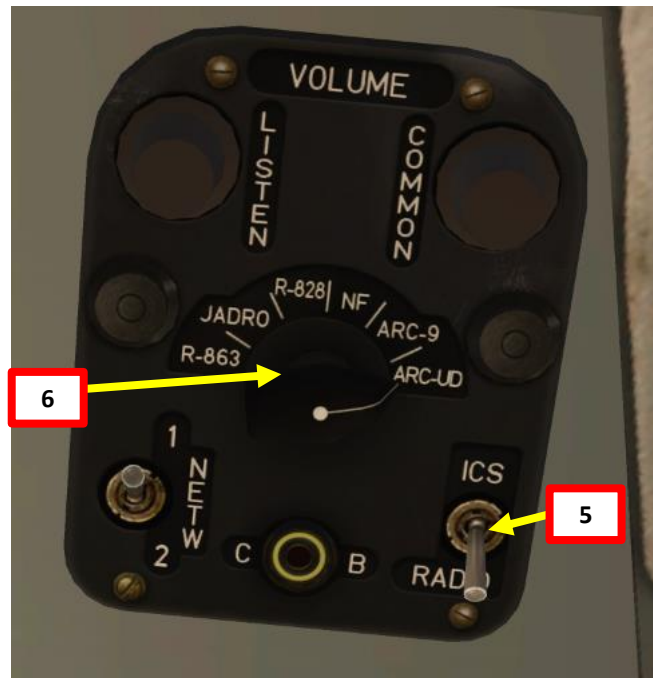
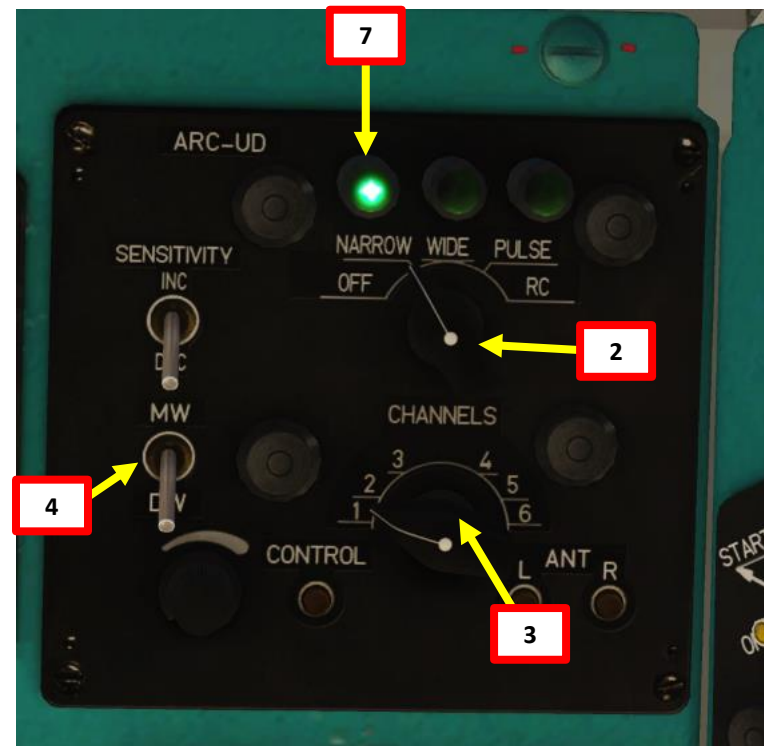



MI-8MTV2  
HIP

PART 14 – RADIO NAVIGATION

ARK-UD **UHF AM** HOMING – SEARCH AND RESCUE



ELT Signal Source



# ARK-UD VHF AM HOMING – SEARCH AND RESCUE

NOTE: THIS METHOD IS USED IF YOU ARE TRACKING A GROUND UNIT TRANSMITTING ON A VHF AM FREQUENCY.

Another interesting functionality of the ARK-UD is that the system can home on a radio transmission emitter. In this case, we will simulate a Search and Rescue mission to recover a stranded Mi-8 helicopter crew. We will first need to set up a mission with a unit that transmits a distress call on a VHF AM frequency of 121.500 MHz.

1. Create Unit that will transmit the distress signal
2. In ADVANCED (WAYPOINT ACTIONS) of Waypoint 0
  - I. Click on ADD
    - a) Select Type - PERFORM COMMAND
    - b) Select ACTION – SET FREQUENCY
    - c) Set Frequency to a valid frequency (121.5 MHz, associated with preset Channel 4)
    - d) Select AM Band
    - e) Select Power (i.e. 100 W)
  - II. Click on ADD
    - a) Select Type - PERFORM COMMAND
    - b) Select ACTION – TRANSMIT MESSAGE
    - c) Select a valid .wav or .ogg audio file with the distress call. Add subtitles if desired.
    - d) Select LOOP

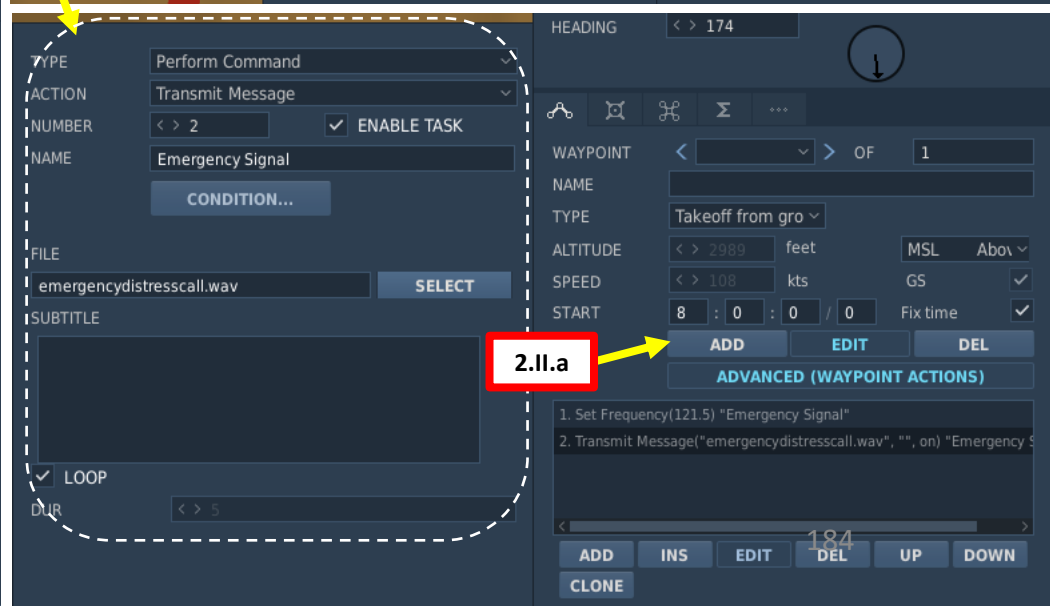
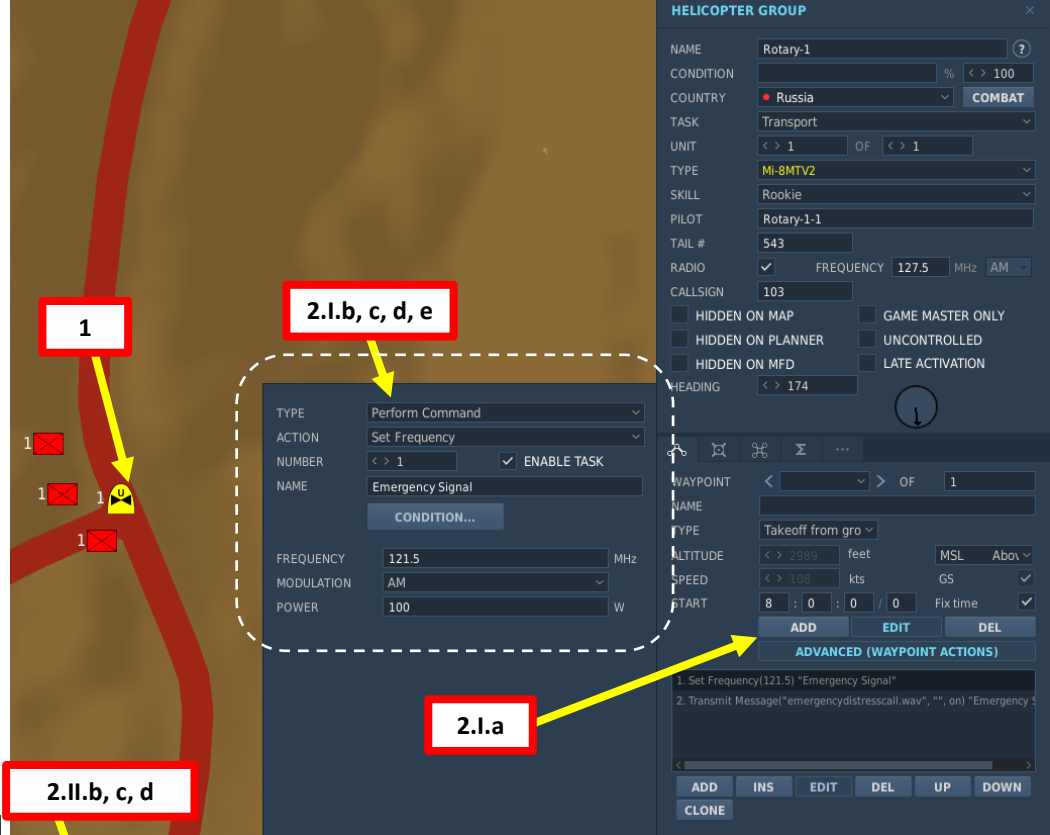

## ARK-UD RADIO CHANNELS & FREQUENCIES

BAND	FREQUENCY (MHz)	PRESET CHANNEL
VHF (AM)	114.166	1
VHF (AM)	114.333	2
VHF (AM)	114.583	3
VHF (AM)	121.5	4
VHF (AM)	123.1	5
VHF (AM)	124.1	6
UHF (AM)	243.0	N/A

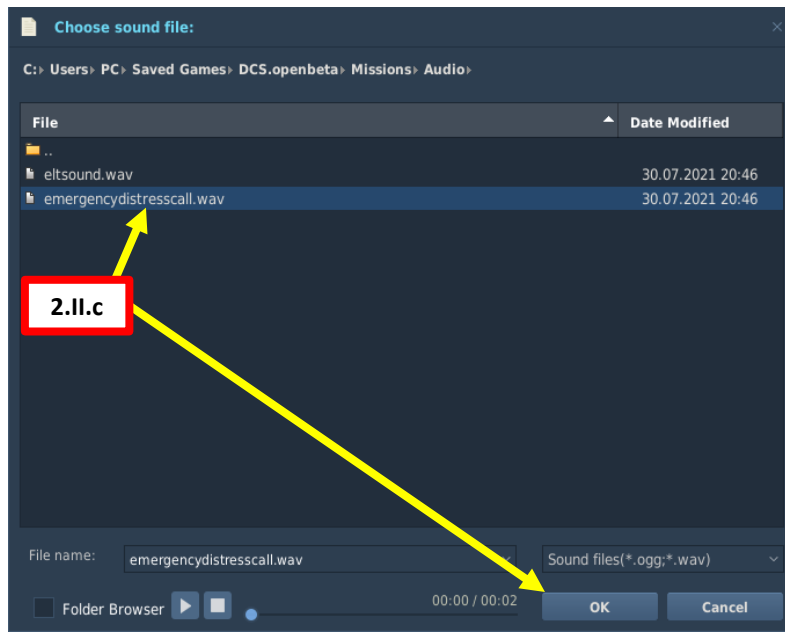

# ARK-UD VHF AM HOMING – SEARCH AND RESCUE

NOTE: THIS METHOD IS USED IF YOU ARE TRACKING A GROUND UNIT TRANSMITTING ON A VHF AM FREQUENCY.

1. Check mission briefing to know which preset channel you need to use.
2. Set ARK-UD mode to NARROW (УП).
3. Set ARK-UD preset channel based on mission briefing (we will use Channel 4 for a VHF AM frequency of 121.5 MHz for this example).
4. Set ARK-UD frequency to appropriate band (for this example we will use VHF (УКВ) ):
  - VHF (УКВ) – UP POSITION for VHF preset channels (“MW” in English cockpit)
  - UHF/AM (ДЦБ) – DOWN POSITION for UHF/AM preset channels (“DW” in English cockpit)
5. Set ICS/RADIO selector to “RADIO” (DOWN)
6. Select ARK-UD radio (PK2).
7. Green light on ARK-UD panel will be lit once signal is picked up.
8. On your HSI, select ARK-UD VHF (УКВ) mode (switch to the right).
9. Follow the white needle to get to target.

ARK-UD RADIO CHANNELS & FREQUENCIES		
BAND	FREQUENCY (MHz)	PRESET CHANNEL
VHF (AM)	114.166	1
VHF (AM)	114.333	2
VHF (AM)	114.583	3
VHF (AM)	121.5	4
VHF (AM)	123.1	5
VHF (AM)	124.1	6

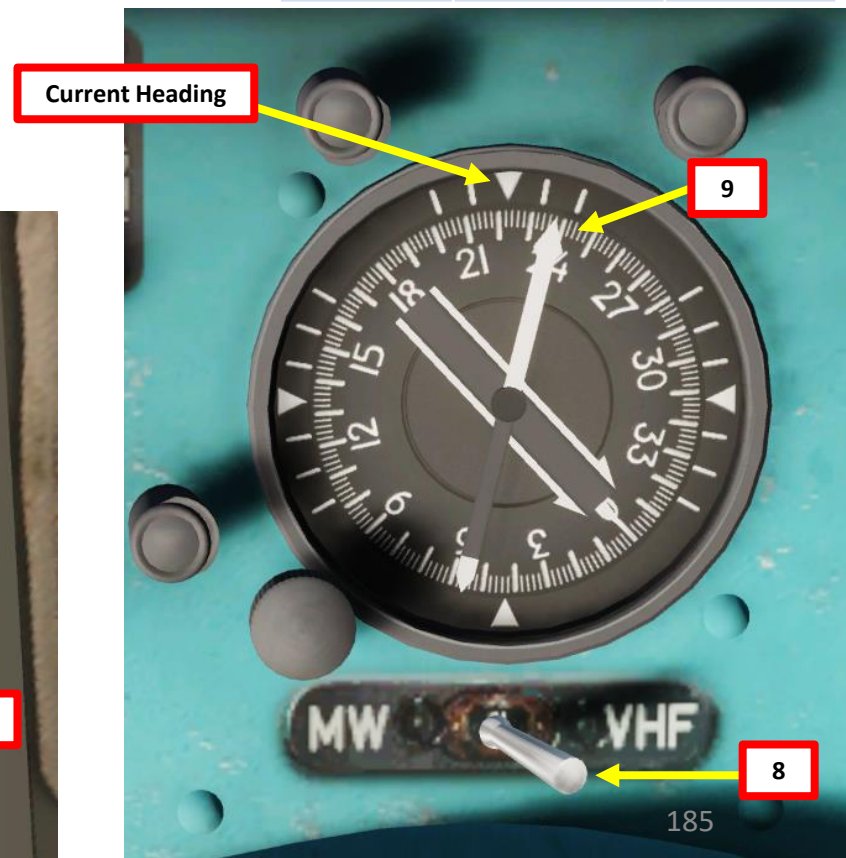
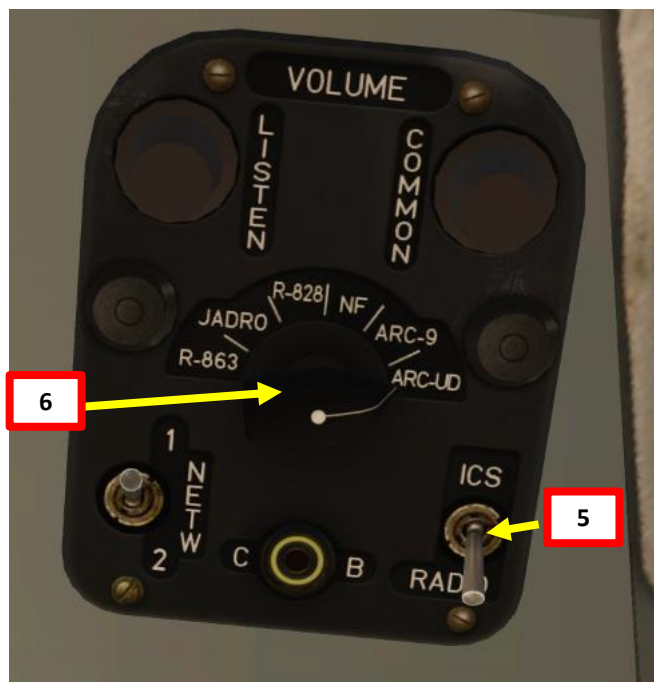
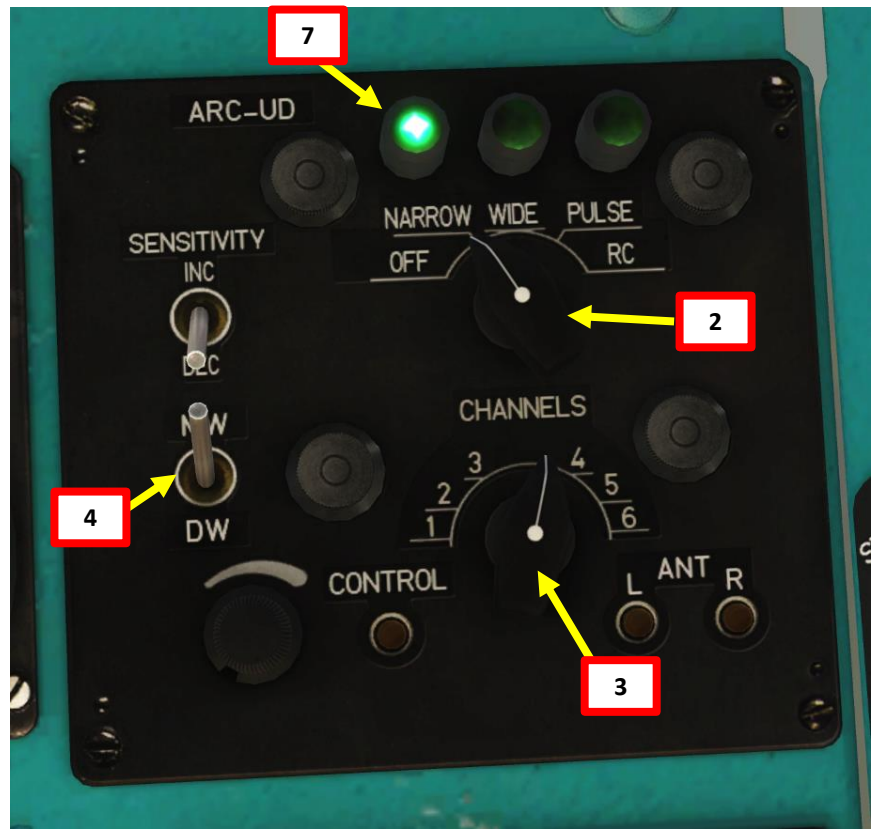



# ARK-UD VHF AM HOMING – SEARCH AND RESCUE



Distress Signal Source

## ARK-UD & R-828 VHF FM HOMING – SEARCH AND RESCUE

NOTE: THIS METHOD IS USED IF YOU ARE TRACKING A GROUND UNIT TRANSMITTING ON A VHF FREQUENCY.

The R-828 radio is often used to communicate with ground troops. Another interesting functionality is that the ARK-UD system can home on the transmission emitter. In this case, we will simulate a Search and Rescue mission to recover a stranded Mi-8 helicopter crew. We will first need to set up a mission with a unit that transmits a distress call on a **VHF FM frequency of 50 MHz**.

1. Create Unit that will transmit the distress signal
2. In **ADVANCED (WAYPOINT ACTIONS)** of Waypoint 0
  - I. Click on **ADD**
    - a) Select Type - **PERFORM COMMAND**
    - b) Select **ACTION – SET FREQUENCY**
    - c) Set Frequency to a valid frequency (50 MHz)
    - d) Select **FM Band**
    - e) Select **Power (i.e. 100 W)**
  - II. Click on **ADD**
    - a) Select Type - **PERFORM COMMAND**
    - b) Select **ACTION – TRANSMIT MESSAGE**
    - c) Select a valid .wav or .ogg audio file with the distress call. Add subtitles if desired.
    - d) Select **LOOP**

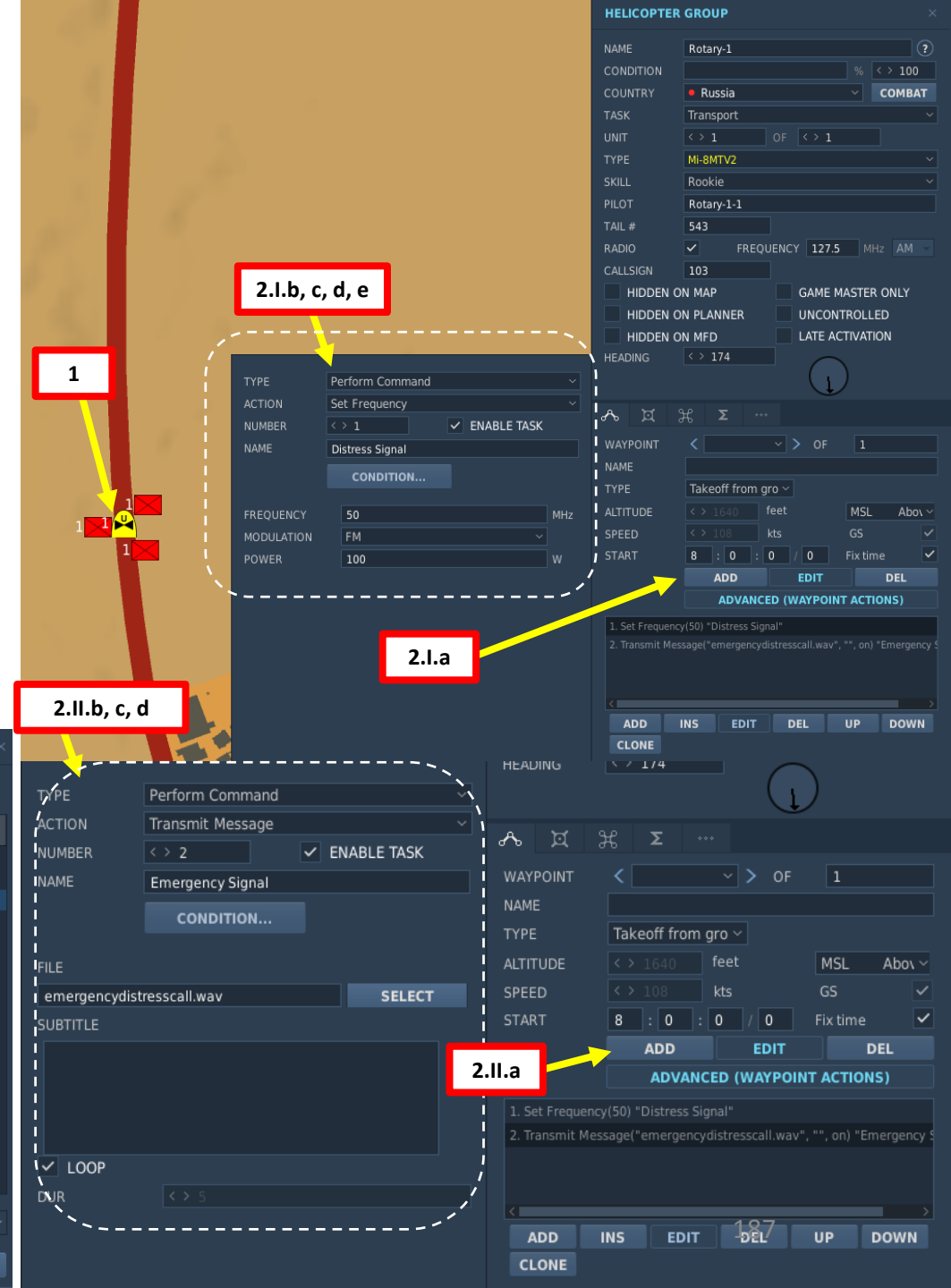
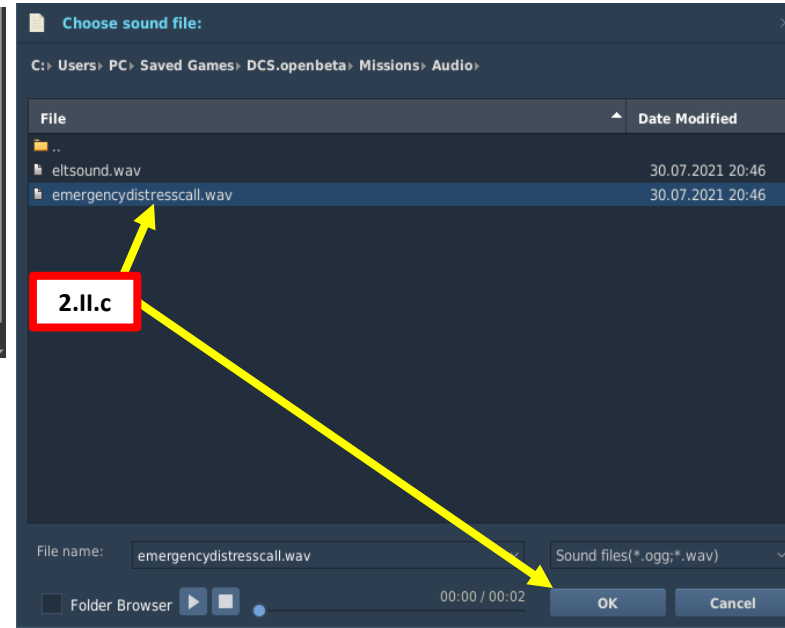
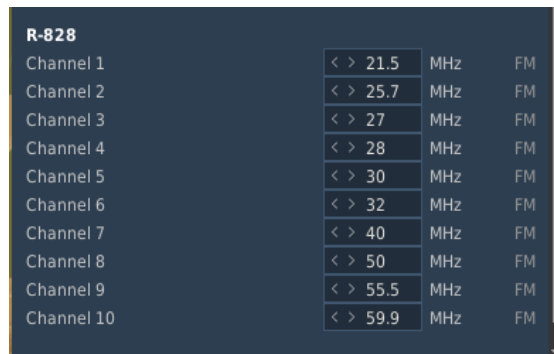



## ARK-UD & R-828 VHF FM HOMING – SEARCH AND RESCUE

NOTE: THIS METHOD IS USED IF YOU ARE TRACKING A GROUND UNIT TRANSMITTING ON A VHF FREQUENCY.

1. Check mission briefing to know which preset channel you need to use.
2. Set ARK-UD mode to NARROW (УП).
3. Set ARK-UD preset channel based on mission briefing (we will use Channel 8 for a VHF frequency for this example).
4. Set ARK-UD frequency to appropriate band (for this example we will use VHF (YKB) ):
  - VHF (YKB) – UP POSITION for VHF preset channels (“MW” in English cockpit)
  - UHF/AM (ДЦБ) – DOWN POSITION for UHF/AM preset channels (“DW” in English cockpit)
5. Set ICS/RADIO selector to “RADIO” (DOWN)
6. Select ARK-UD radio (PK2).
7. Green light on ARK-UD panel will be lit once signal is picked up.
8. Set R-828 radio – ON (FWD)
9. Set R-828 mode to COMPASS (FWD)
10. Select VHF preset frequency (given in mission briefing). We will use Channel 8 for a VHF frequency for this example since it matches with 50 MHz.
11. Press and hold down ACY button (AGC in English cockpit) to enable “automatic gain control”. Wait until the green squelch light flickers to confirm signal reception.
12. On your HSI, select ARK-UD VHF (YKB) mode (switch to the right).
13. Follow the white needle to get to target.

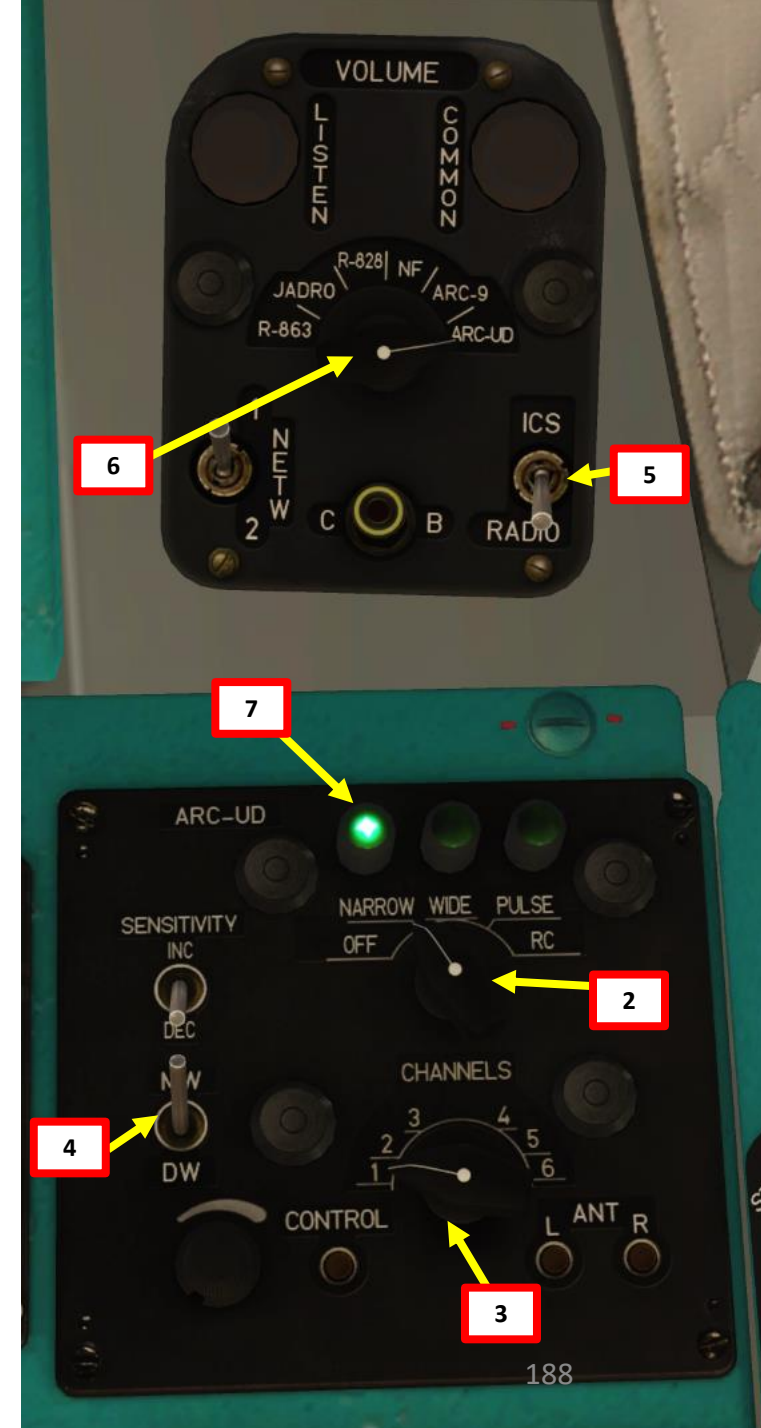
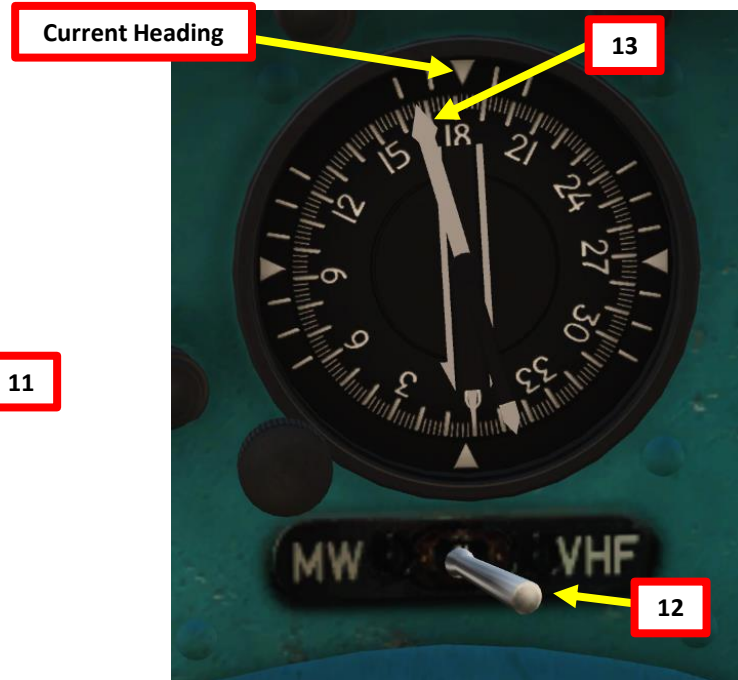
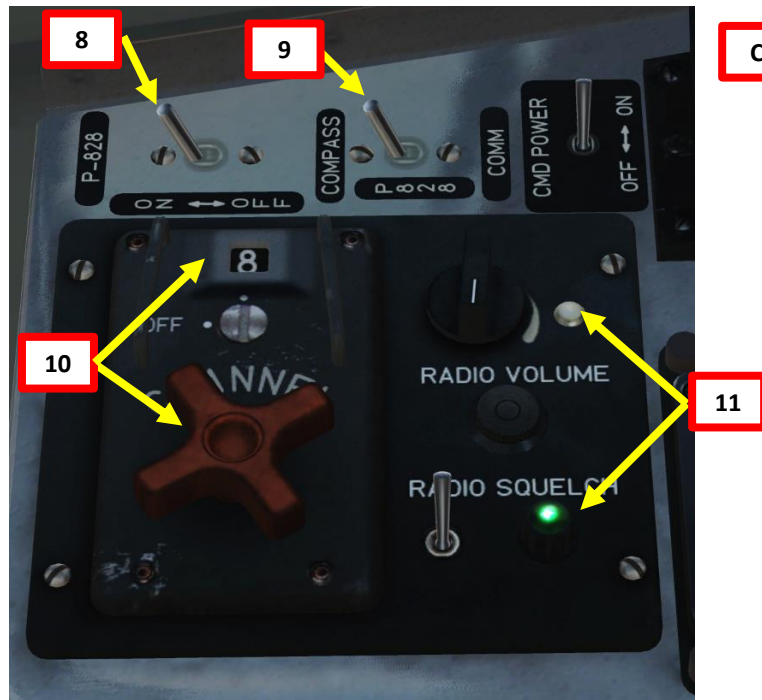



# ARK-UD & R-828 VHF FM HOMING – SEARCH AND RESCUE





## DISS-15 DOPPLER SYSTEM – IN A NUTSHELL

Old generation aircraft traditionally navigate using a magnetic compass and a directional gyro. A needle points somewhere, and by staying the course they expect to arrive to their destination. However, real life is not so simple. Wind can have a dramatic effect on navigation, especially on long-distance flights. If a pilot follows a certain heading and wind is pushing him sideways, he can start drifting and be completely off course. The compass will tell him that he is going in a certain direction (and in a certain sense, he is facing a direction that is parallel to the direction he intends to take) but in reality he will be drifting away.

This is why Doppler navigation systems were conceived: it allowed the pilot to fly to a certain heading and detect whether or not the wind is pushing him off course.

The Doppler effect is probably that boring phenomenon you heard about in high school and didn't care about at the time. Basically, the Doppler effect is the reason why airplane fly-bys in airshows are so awesome to listen to: a moving object (like a plane) is emitting waves (like sound waves) that are received by an observer (you), and the frequency of this wave (like the sound pitch) will change the closer or farther the aircraft comes to you.

A Doppler system installed on the Mi-8 transmits and receives waves, and a computer calculates your ground speed and drift angle. It also gives a more responsive approximation of your vertical speed, which is very useful to know if you are sinking too quickly during precision approaches. Pretty cool, eh?

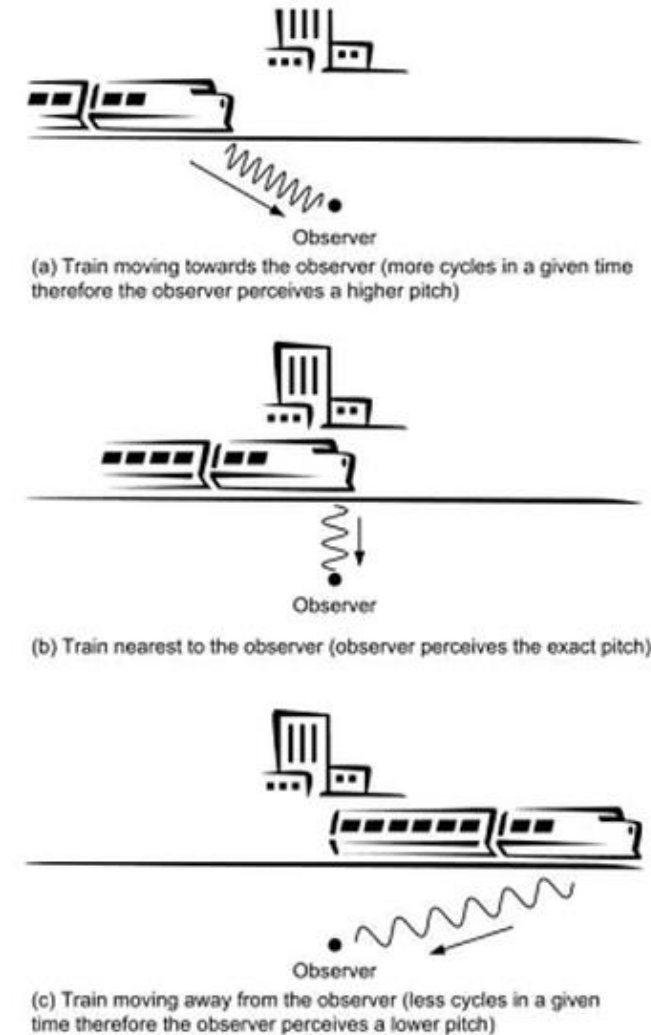
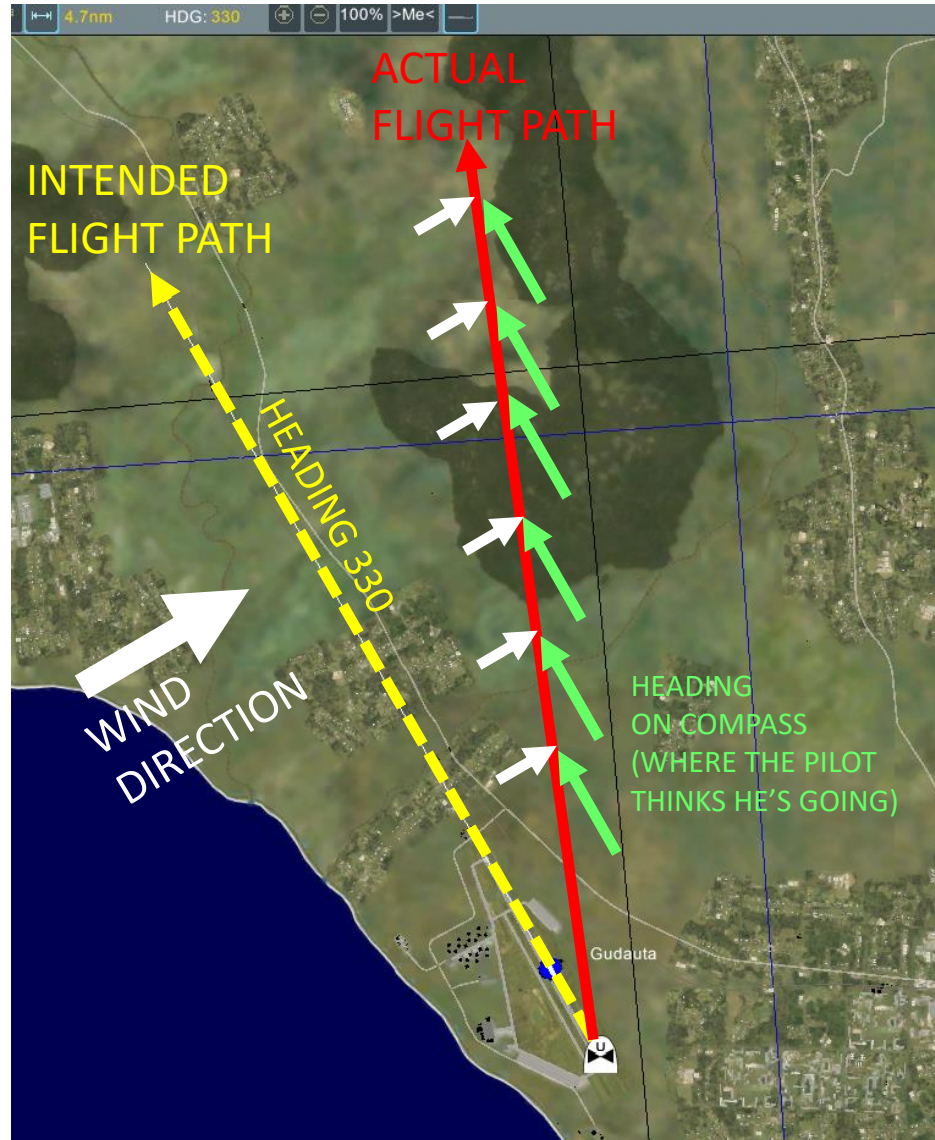

Figure 15.1 The Doppler effect



# DISS-15 DOPPLER SYSTEM – THE BASICS

The Doppler System is used for leg navigation (i.e. navigating from point A to point B, and then to point C...). If you have a map and a set of waypoints, you can create a flight plan from a starting reference point (i.e. fly for 20 km at a 330 heading, then fly for 30 km at a 090 heading...) and use the Doppler system to monitor the distance you travelled from the reference point and how far you are drifting from your real intended flight path. Using the Doppler system is very simple: you turn it on and set your reference point, follow the heading using the HSI (Horizontal Situation Indicator) and make sure the drift displayed is equal to 0.

**Doppler Navigation Tutorial by SlocketSeven**  
<https://www.youtube.com/watch?v=x9I6xi1XVrQ>

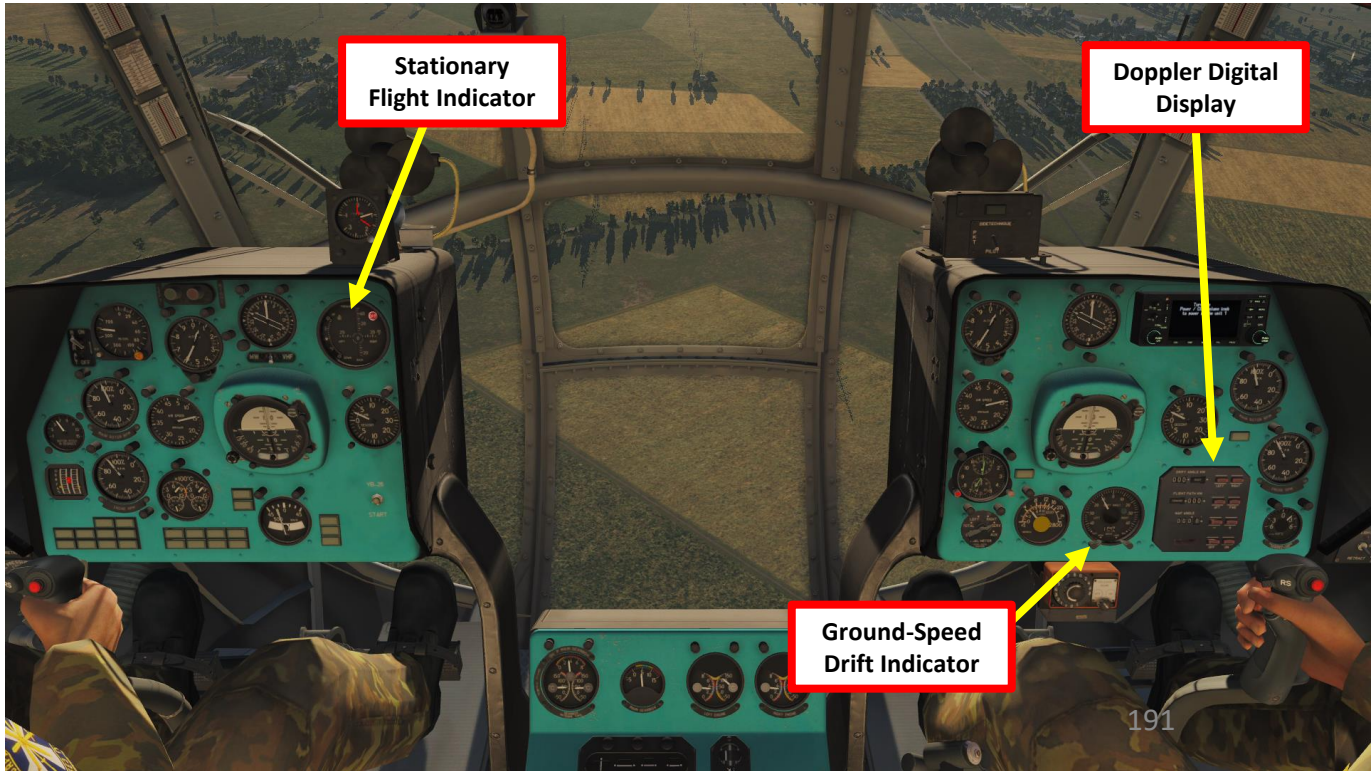
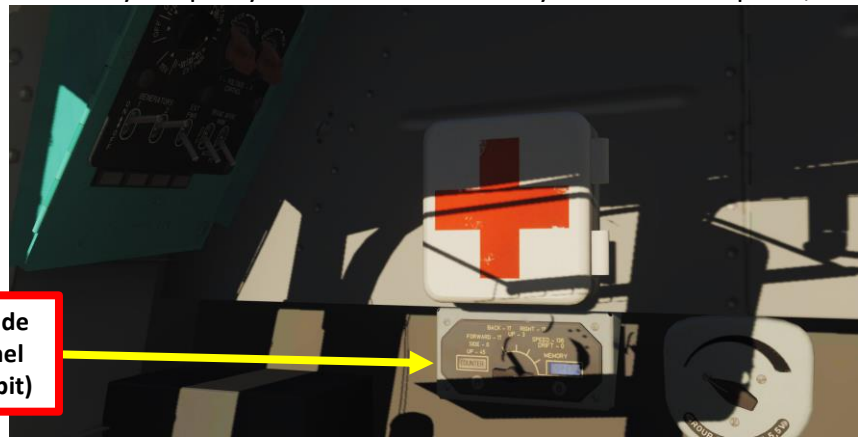
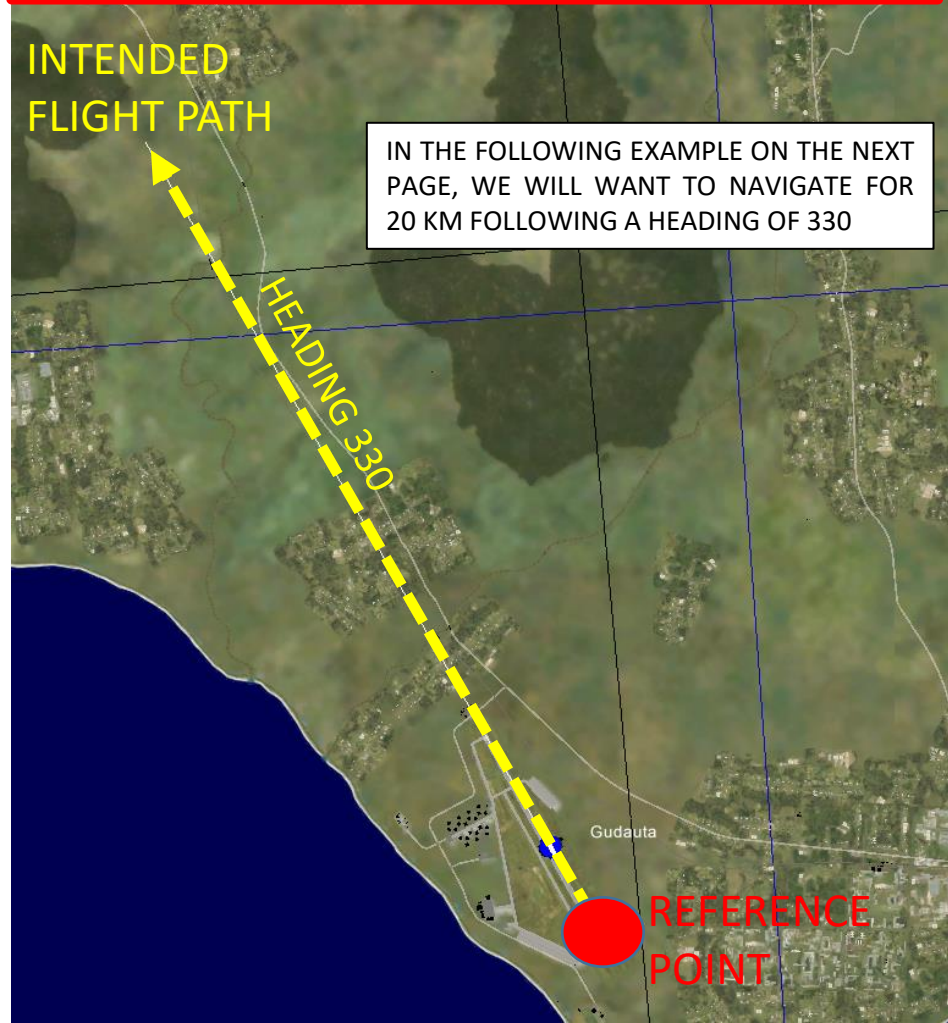



# DISS-15 DOPPLER SYSTEM – NAVIGATION TUTORIAL

1. Select Co-Pilot by pressing “2”.
2. Turn ON (UP) Doppler & 5.5V Lights systems.
3. Set Doppler System mode to OPERATE (PA5OTA) and front panel brightness as required.
  - Note: Look behind you to locate Doppler panel.
4. Set your Doppler ground speed & drift indicator to “C” (LAND) or “M” (SEA) depending on where you will fly over.
5. Set your Doppler ground speed & drift indicator to “P” (OPERATE).
6. Set your LATERAL DRIFT (km) to 0 using the LEFT and RIGHT buttons.
7. Set your DISTANCE (km) to either 0 (if you want to have a counter of the distance you travelled so far) or to the distance you want to travel using the “H” (AFT) button (if you want to have a counter that tells you how close you are to your waypoint).
8. Set your HEADING ANGLE (degrees) to 330 deg & 0 minute.
9. Set Doppler System to ON to tell the system to take your current location as your reference point.

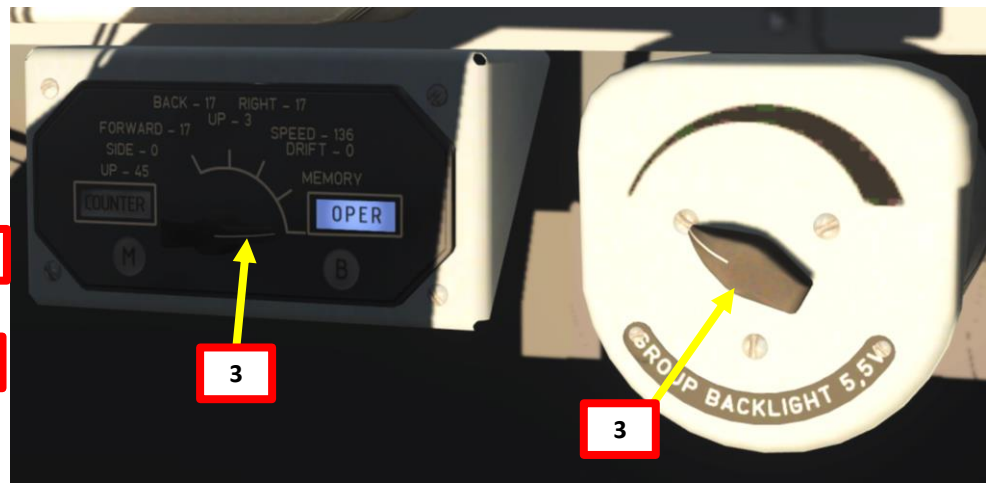
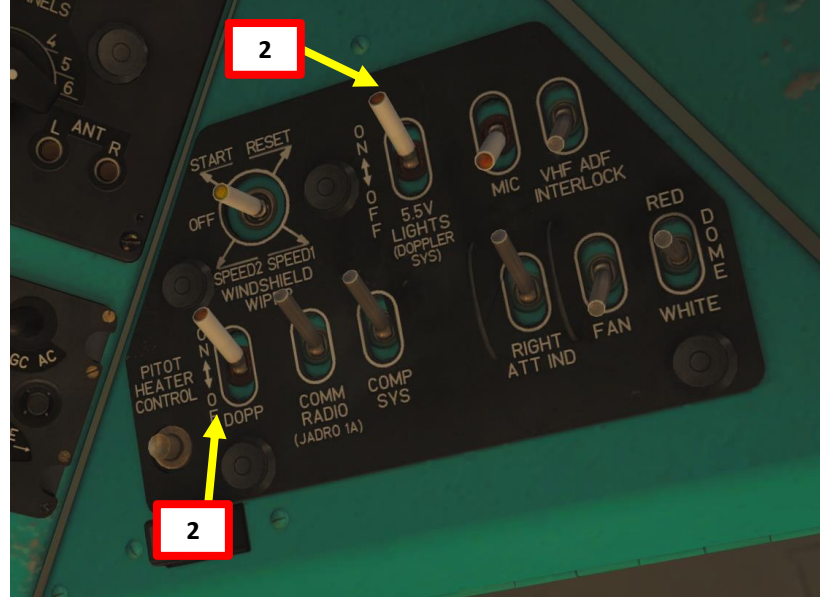

# DISS-15 DOPPLER SYSTEM – NAVIGATION TUTORIAL

- Set your HSI (Horizontal Attitude Indicator) course setter to 330. This is useful to have a reference heading to consult to compare the aircraft heading against the actual course deviation.
- Fly on desired course by using the HSI heading as a rough reference for direction (keep in mind that the heading and course of the HSI may not correspond to the desired course if you have to fly “crabbed” due to winds) and the Drift Angle indicator to know how much you deviate from the programmed course plotted. You can monitor your drift angle and your speed using the Ground Speed & Drift Angle Indicator.

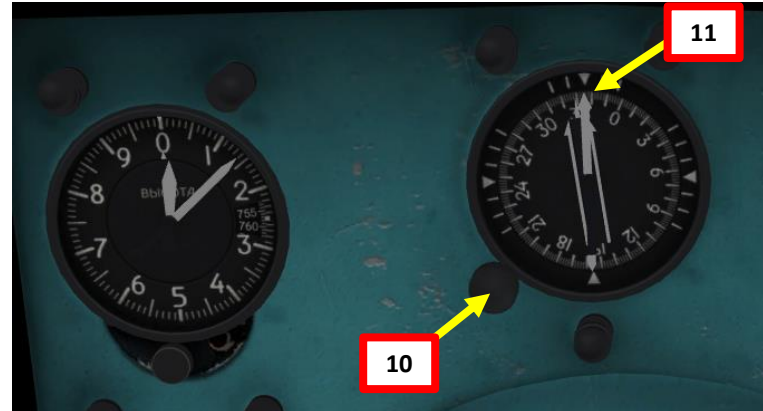

In this example, we are 8 degrees off course. This is what the HSI (Horizontal Situation Indicator) and the Doppler Ground Speed & Drift Angle indicators are saying.





## DISS-15 DOPPLER – STATIONARY FLIGHT INDICATOR

The Doppler system is not only useful for ground speed: it is also useful for low speed or stationary flight (hover). The Stationary Flight Indicator needs the Doppler system to be set to OPERATE (PA6OTA) as shown in previous Doppler Tutorials.

Why would you need this Doppler indicator if you already have vertical velocity and airspeed indicators? Well, normal airspeed gauges rely on pitot tubes and air pressure in order to derive an airspeed from pressure values.

The Doppler System does not rely on air pressure: it is a separate system that relies on the wave transmitter and receivers installed on the airframe itself. The advantage of the Doppler System is that it is much more responsive (meaning that you will have a quicker approximation of your actual velocity), which is very useful when you are coming for precision approaches.

You can do the test yourself and compare the vertical velocity indicator under the SFI with the vertical speed value displayed on the Stationary Flight Indicator. You will notice that the SFI gives you a quicker and better approximation.

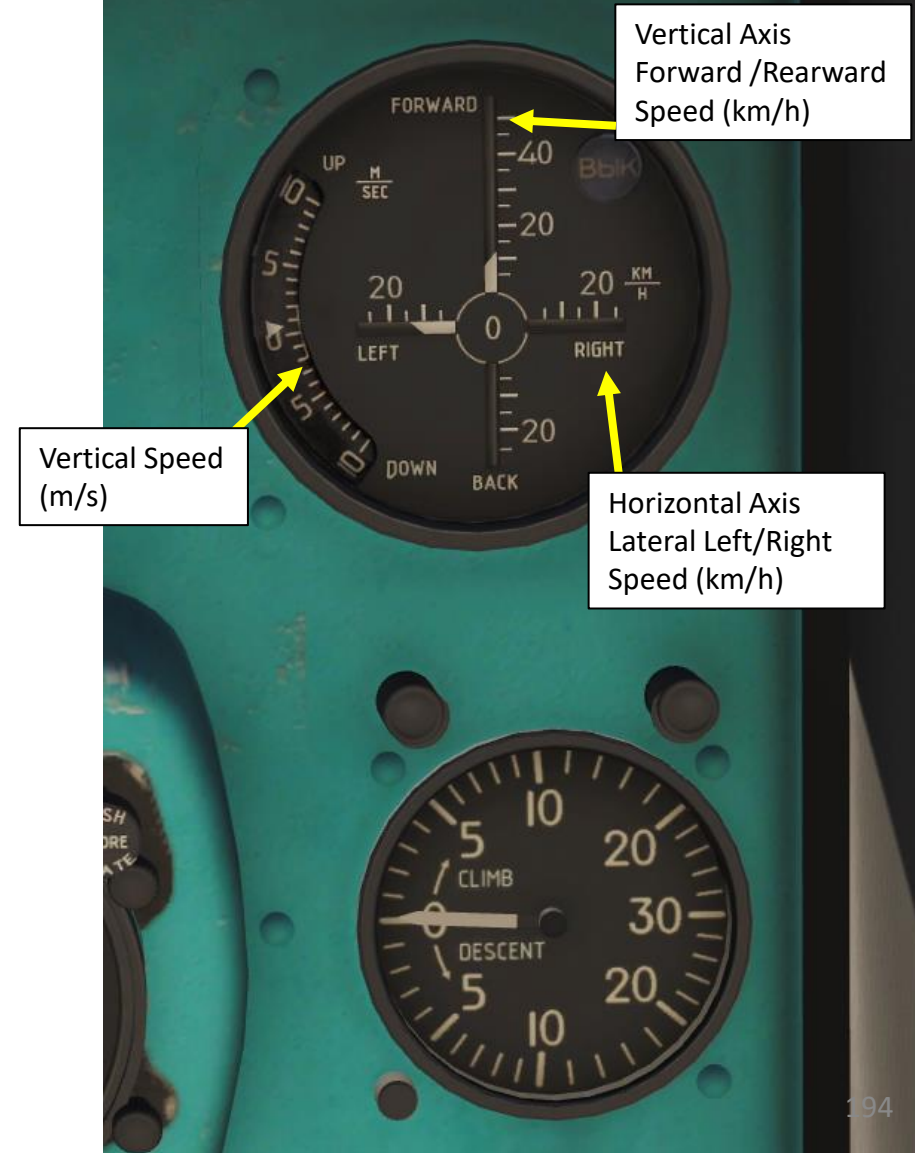

The AP-34B four channel autopilot system is designed to stabilize control of the helicopter in roll, pitch, heading, altitude, and airspeed. The four autopilot channels (roll, pitch, yaw, altitude) provide:

- stabilization of helicopter attitude in three axes (longitudinal, lateral, vertical);
- stabilization of altitude in forward flight and hover;
- stabilization of indicated airspeed;

When the altitude channel is engaged, the pitch channel receives correction signals from the КЗСП (KZSP) airspeed correction unit to stabilize the airspeed. The pilot may intervene at any time while the autopilot is engaged to make manual corrections by operating the flight controls. The hydraulic flight control servos apply autopilot corrections to the flight controls surfaces and provide feedback signals to the autopilot channels. **Autopilot roll, pitch, and altitude correction signals are limited to a maximum of 20% of control travel for flight safety in the event of false signals or system failure.** The autopilot system is supplied with roll and pitch data by the copilot's (right) attitude indicator. Heading data is supplied by the GMK-1A gyro compass system.

With the HEADING channel on, course adjustments can be made by turning the HEADING wheel on the IN-4 zero indicator unit. A full turn from one stop to the other corresponds to 10° of heading change. The autopilot system can be disengaged by pressing the "ВЫКЛ. АП" (Autopilot OFF) button on either cyclic control stick. The autopilot system is engaged for all normal flight operations. The pitch, roll, and yaw channels are engaged throughout the flight from takeoff to landing.

The system is turned on by pressing the individual button-lamps of the corresponding autopilot channels prior to takeoff. When performing a vertical take-off, the pitch, roll, and yaw channels are engaged. When performing a rolling takeoff, only the pitch and roll channels are engaged. When in hover, the autopilot stabilizes the helicopter in pitch and roll, as well as heading when the pedals are released (feet off the pedals). Autopilot functionality in hovering flight can be verified by checking the zero indicator unit for fluctuations in the "K/B" (roll channel) "T/P" (pitch channel) "H" (yaw channel) servo displacement indicator needles.





**Trim Indicator Panel of Automatic Flight Control System (AFCS)**

- *H*: Yaw Trim Indicator
- *B (Rus: K)*: Bank Trim Indicator
- *P (Rus: T)*: Pitch Trim Indicator
- *A (Rus: B)*: Altitude Trim Indicator

**Autopilot Pitch & Roll Mode Button**  
GREEN = ON

**Autopilot Heading Mode Button**  
GREEN = ON  
RED = OFF

**Autopilot Altitude Mode Button**  
GREEN = ON  
RED = OFF

Rotating scale indicating mismatch between signals from yaw, roll and pitch sensors and actual controls position (1 mark corresponds to 1°)

**Autopilot Yaw / Roll / Pitch Controls**

**Autopilot Altitude Control**  
Left Click = DOWN  
Right Click = UP

**Force Trim Button**

**Autopilot Disengage Button**

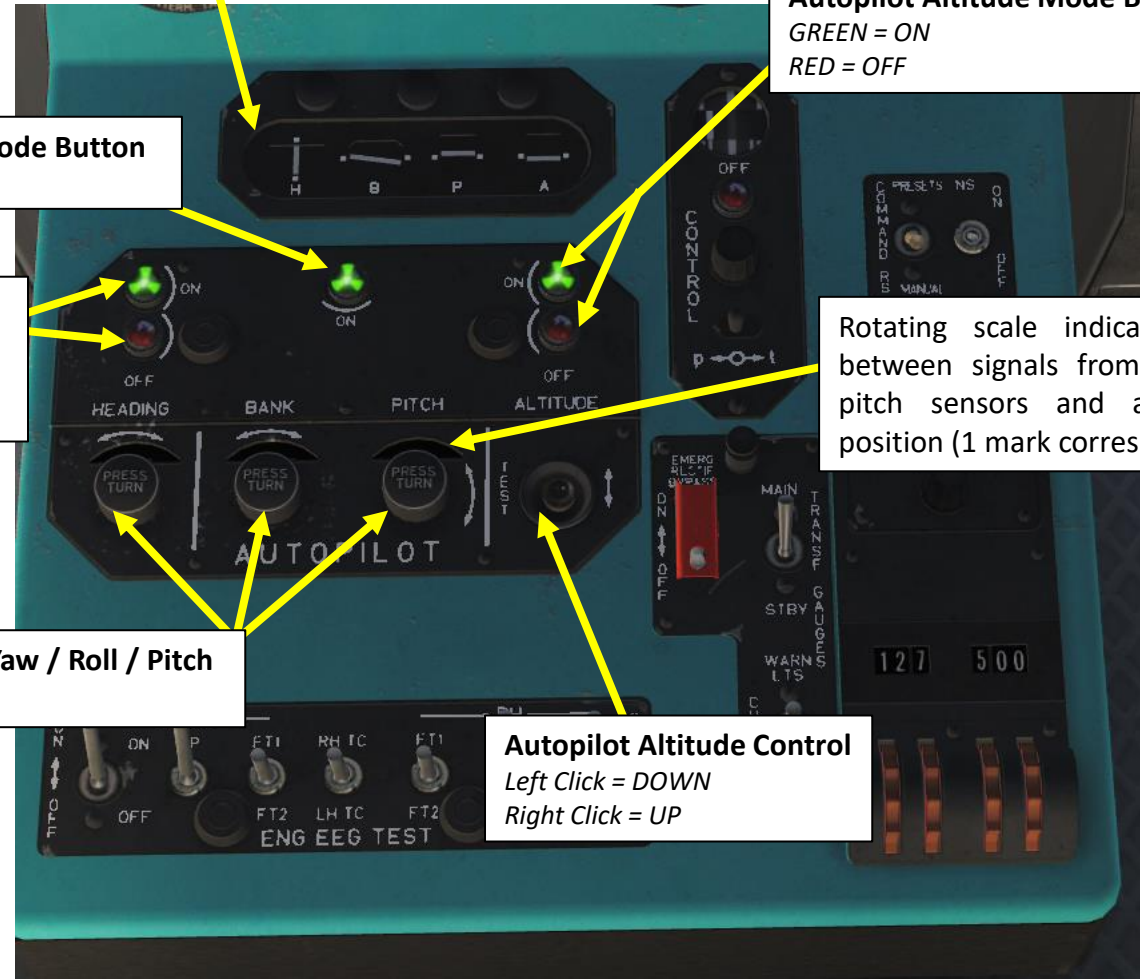

## AUTOPILOT OPERATION

The autopilot has three main modes, which can be combined together:

- Pitch-Roll Mode
- Heading Mode
- Altitude Mode

### 1. PITCH-ROLL

In Pitch-Roll Mode, the autopilot will attempt to maintain your current bank and pitch angle. This is mainly used for hovering, rolling takeoffs and general flying.

- To engage Pitch-Roll, press the Pitch-Roll lamp-button.
- To disengage, press the Pitch-Roll lamp-button again or press the Autopilot Disengage Button on the cyclic.

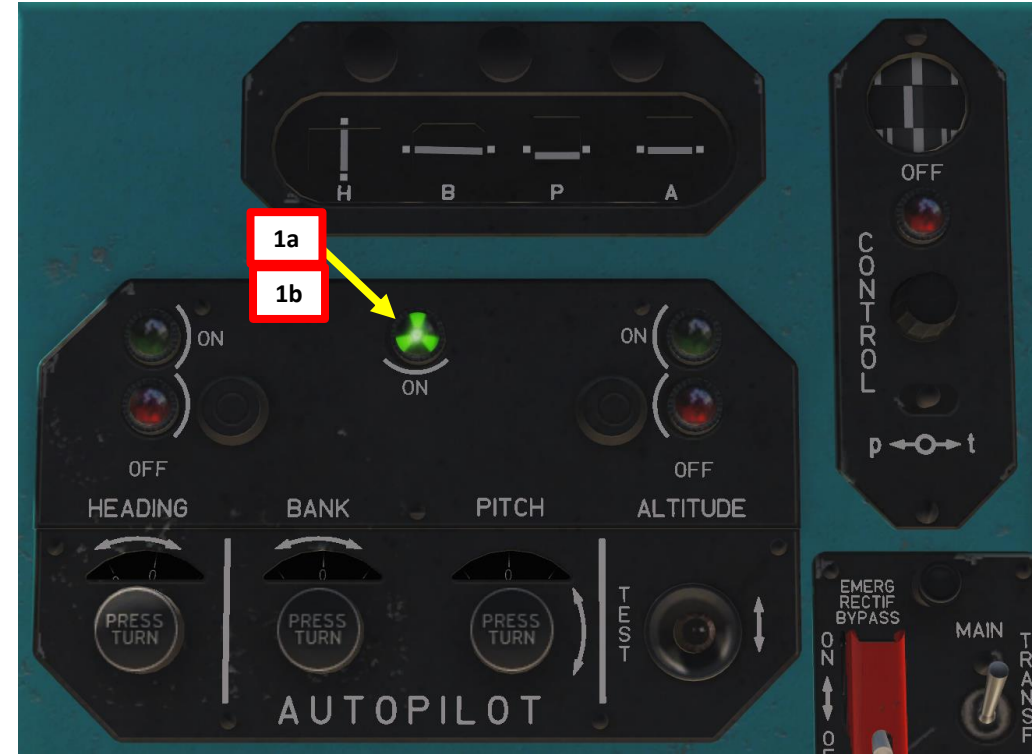



## AUTOPILOT OPERATION

### 2. HEADING HOLD/ADJUST

- Set cyclic to hold a constant heading.
- Engage the Heading Mode lamp-button, then immediately turn the Yaw Control knob until the display scale shows 0 deg of mismatch between the autopilot and the control position. This basically “zeroes” the autopilot heading reference to your current heading (as an example, we will assume our current reference heading is 294).
- The Heading Mode will then **hold** your current heading.
- To **adjust** the autopilot heading (max 10 deg left or 10 deg right), turn the Heading Mode button until the rotating scale displays the desired heading offset (shown: 5 deg right).
- The autopilot will then steer the helicopter 5 degrees right (299) of your reference heading (294) and maintain this heading.
- To disengage, press the Heading Mode OFF lamp-button or press the Autopilot Disengage Button on the cyclic.



Rotating scale indicating mismatch between signals from yaw, roll and pitch sensors and actual controls position (1 mark corresponds to 1°)

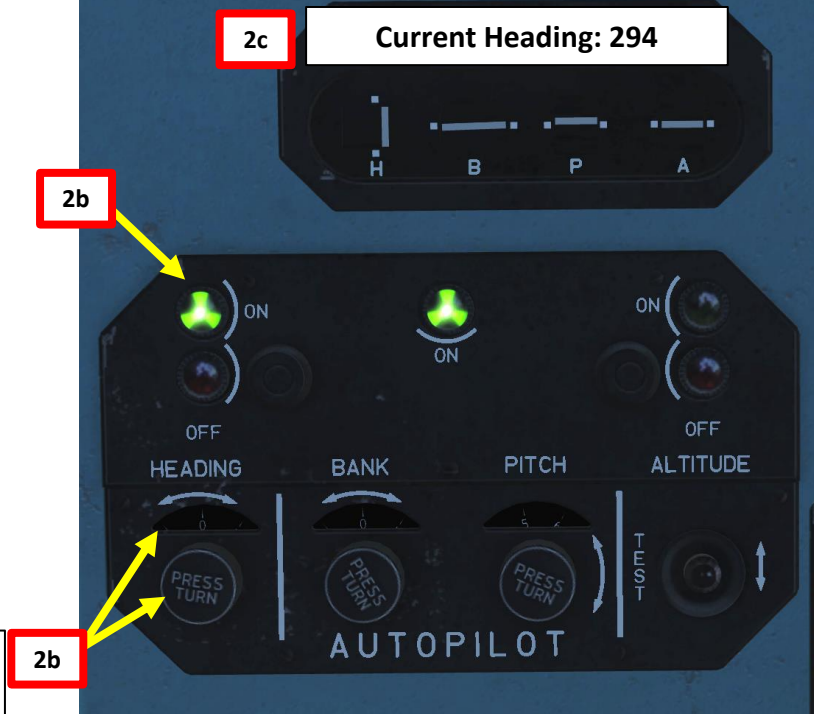

## AUTOPILOT OPERATION

### 3. ALTITUDE HOLD/ADJUST

- Set collective and cyclic to hold a constant altitude.
- Engage the Altitude Mode lamp-button. This basically “zeroes” the autopilot altitude reference to your current altitude.
- The Altitude mode will then hold your current altitude.
- To adjust the altitude, use the Autopilot Altitude Control Switch (UP/FWD will increase altitude, DOWN/AFT will decrease altitude)
- The autopilot will then adjust the helicopter pitch to increase altitude for as long as you hold the Altitude Control Switch.
- To disengage, press the Altitude Mode OFF lamp-button or press the Autopilot Disengage Button on the cyclic.





# MULTICREW

The Mi-8 can be flown by two players in multiplayer. You can also take two additional players as a flight engineer or a gunner. However, you need to go in the Mission Editor and make sure the Huey is set up in the following manner:

1. Select Mi-8 Unit and go in “Additional Properties for Aircraft” menu
2. Make sure “Disable Multicrew” option is not ticked
3. Set “Aircraft Control Priority” to “Equally Responsible”
4. When spawning in multiplayer in any seat, the pilot will receive a request to let you take control of the other seat.
5. Once you are spawned, you can take control of the aircraft by pressing the “Request Aircraft Control” binding (“C” key). The other crew member you are taking controls from must accept.

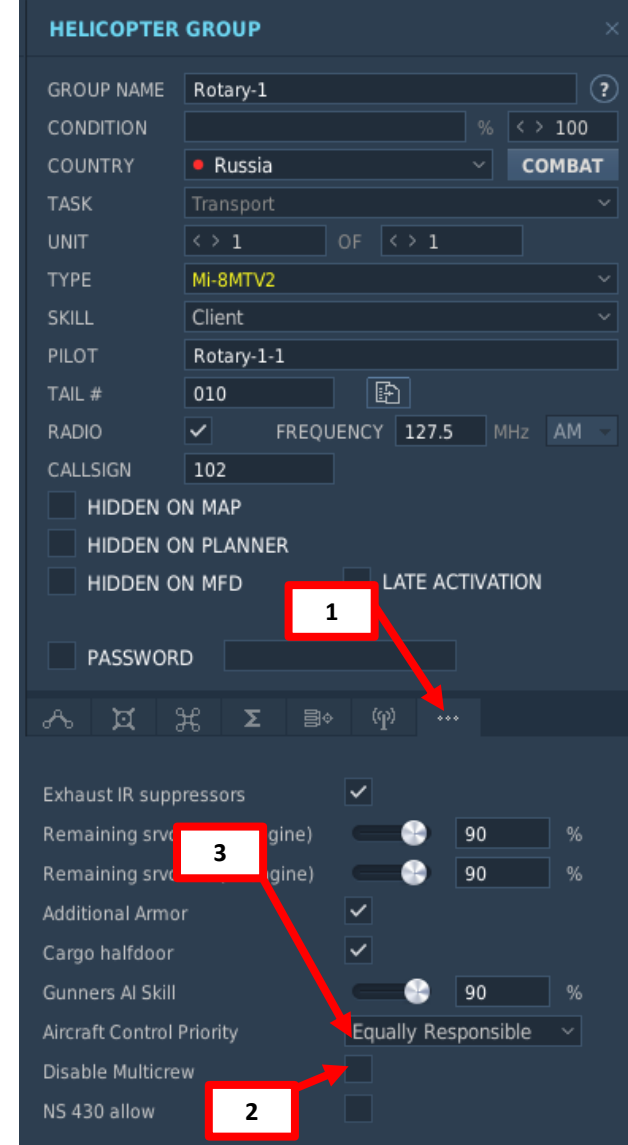
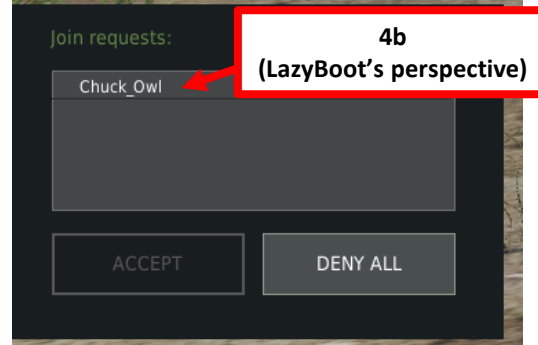
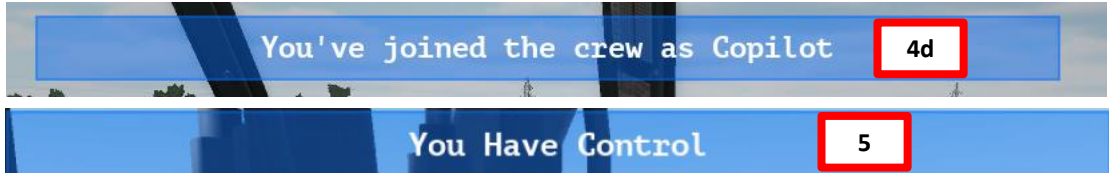

BLUE COALITION		13 players					PLAYERS POOL	Chuck_Owl
Group	Unit Type	Position	Country	#	Airfield	Player		
FARP Hoggy Mi-8 Ford 2	Mi-8MTV2	Pilot	CJTF Blue	065	Ground	Metal 1-2   LazyBoot		
FARP Hoggy Mi-8 Ford 2 (Metal 1-2   LazyBc	Mi-8MTV2	Copilot	CJTF Blue	065	Ground			
FARP Hoggy Mi-8 Ford 2 (Metal 1-2   LazyBc	Mi-8MTV2	Technician	CJTF Blue	065	Ground			
FARP Hoggy Mi-8 Ford 2 (Metal 1-2   LazyBc	Mi-8MTV2	Left Gunner	CJTF Blue	065	Ground			
FARP Hoggy Mi-8 Ford 3	Mi-8MTV2	Pilot	CJTF Blue	065	Ground			
FARP Hoggy Mi-8 Ford 3 (No Pilot)	Mi-8MTV2	Copilot	CJTF Blue	065	Ground			
FARP Hoggy Mi-8 Ford 3 (No Pilot)	Mi-8MTV2	Technician	CJTF Blue	065	Ground			
FARP Hoggy Mi-8 Ford 3 (No Pilot)	Mi-8MTV2	Left Gunner	CJTF Blue	065	Ground			
FARP Hoggy Mi-8 Ford 4	Mi-8MTV2	Pilot	CJTF Blue	065	Ground			
FARP Hoggy Mi-8 Ford 4 (No Pilot)	Mi-8MTV2	Copilot	CJTF Blue	065	Ground			
FARP Hoggy Mi-8 Ford 4 (No Pilot)	Mi-8MTV2	Technician	CJTF Blue	065	Ground			
FARP Hoggy Mi-8 Ford 4 (No Pilot)	Mi-8MTV2	Left Gunner	CJTF Blue	065	Ground			
Senaki Mig15 Chevy 6			USA	010	Senaki-Kolkhi - 08			
Senaki Mig15 Chevy 7		Pending request to	USA	010	Senaki-Kolkhi - 28			
Senaki Mig15 Chevy 6 -1			USA	010	Senaki-Kolkhi - 07			
Senaki Mig15 Chevy 7-1		Metal 1-2   LazyBoot	USA	010	Senaki-Kolkhi - 29			
Kutaisi MiG-19 Uzi 7 #001			CJTF Blue	010	Kutaisi - 25			
Kutaisi MiG-1			CJTF Blue	010	Kutaisi - 24			

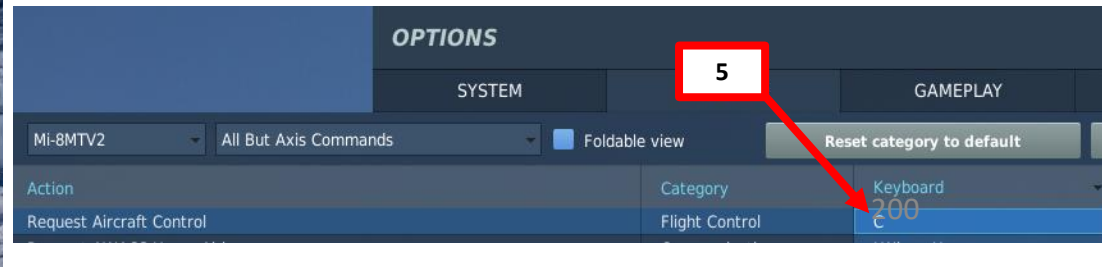

# MULTICREW

Note: you can press "LWIN+H" to display other players in the crew.

- PLAYER is displayed next to your position
- NET is displayed next to another player's position

**Note: this feature is not implemented yet as of 2023/09/20.**

Huey Interface



Mi-8 Interface (2023/09/20)



MULTIPLAYER - Select role

Hoggit - Training Server 147.135.10.14:10308

Search AVAILABILITY UNIT TYPE POSITION AIRFIELD Available filters: 12 Clear all filters

Spectators	BLUE COALITION	13 players	PLAYERS POOL	Chuck_Owl			
Hoggy	Group	Unit Type	Position	Country	#	Airfield	Player
Sentinel 1-1	FARP Hoggy Mi-8 Ford 2	Mi-8MTV2	Pilot	CJTF Blue	065	Ground	Metal 1-2   LazyBoot
Thor 68	FARP Hoggy Mi-8 Ford 2 (Metal 1-2   LazyBt	Mi-8MTV2	Copilot	CJTF Blue	065	Ground	Chuck Owl
Player	FARP Hoggy Mi-8 Ford 2 (Metal 1-2   LazyBt	Mi-8MTV2	Technician	CJTF Blue	065	Ground	
JHWANBAE3	FARP Hoggy Mi-8 Ford 2 (Metal 1-2   LazyBt	Mi-8MTV2	Left Gunner	CJTF Blue	065	Ground	
tyler	FARP Hoggy Mi-8 Ford 3	Mi-8MTV2	Pilot	CJTF Blue	065	Ground	
	FARP Hoggy Mi-8 Ford 3 (No Pilot)	Mi-8MTV2	Copilot	CJTF Blue	065	Ground	
	FARP Hoggy Mi-8 Ford 3 (No Pilot)	Mi-8MTV2	Technician	CJTF Blue	065	Ground	
	FARP Hoggy Mi-8 Ford 3 (No Pilot)	Mi-8MTV2	Left Gunner	CJTF Blue	065	Ground	





# STANDARD COMMUNICATIONS

**Abort**--terminate a preplanned aircraft maneuver.  
**Affirmative**--yes.  
**Bandit**--an identified enemy aircraft.  
**Braking**--announcement made by the crew member who intends to apply brake pressure.  
**Break**--immediate action command to perform an emergency maneuver to deviate from the present ground track; will be followed by the word "right," "left," "up," or "down."  
**Call out**--command by the pilot on the controls for a specified procedure to be read from the checklist by the other crew member.  
**Cease fire**--command to stop firing but continue to track.  
**Clear**--no obstacle present to impede aircraft movement along the intended ground track. Will be preceded by the word "nose," "tail," or "aircraft" and followed by the direction; for example, "left," "right," "slide left," or "slide right." Also indicates that ground personnel are authorized to approach the aircraft.  
**Come up/down**--command to change altitude up or down; normally used to control masking and unmasking operations.  
**Contact**--establish communication with... (followed by the name of the element).  
**Controls**--refers to aircraft flight controls.  
**Drifting**--an alert of the unintentional or undirected movement of the aircraft; will be followed by the word "right," "left," "backward," or "forward."  
**Egress**--command to make an emergency exit from the aircraft; will be repeated three times in a row.  
**Execute**--initiate an action.  
**Expect**--anticipate further instructions or guidance.  
**Firing**--announcement that a specific weapon is to be fired.

Figure 6-4. Examples of standard words and phrases

**Fly heading**--command to fly an assigned compass heading. (This term generally used in low-level or contour flight operations.)  
**Go ahead**--proceed with your message.  
**Go AJ**--directive to activate antijam communications.  
**Go plain**--directive to discontinue secure operations.  
**Go secure**--directive to activate secure communications.  
**Go red**--directive to discontinue secure operations.  
**Hold**--command to maintain present position.  
**Hover**--horizontal movement of aircraft perpendicular to its heading; will be followed by the word "left" or "right."  
**Inside**--primary focus of attention is inside the cockpit for longer than two to three seconds.  
**Jettison**--command for the emergency or unexpected release of an external load or stores; when followed by the word "door," will indicate the requirement to perform emergency door removal.  
**Maintain**--command to continue or keep the same.  
**Mask/unmask**--to conceal aircraft by using available terrain features and to position the aircraft above terrain features.  
**Mickey**--a Have Quick time-synchronized signal.  
**Monitor**--command to maintain constant watch or observation.  
**Move aft**--command to hover aft, followed by distance in feet.  
**Move forward**--command to hover forward, followed by distance in feet.  
**Negative**--incorrect or permission not granted.  
**Negative contact**--unable to establish communication with... (followed by name of element).  
**No joy**--target, traffic, or obstruction not positively seen or identified.  
**Now**--indicates that an immediate action is required.  
**Outside**--primary focus of attention is outside the aircraft.  
**Put me up**--command to place the P\* radio transmit selector switch to a designated position; will be followed by radio position numbers on the intercommunication panels (1, 2, 3). Tells the other crew member to place a frequency in a specific radio.  
**Release**--command for the planned or expected release of an external load.

Figure 6-4. Examples of standard words and phrases (continued)

**Report**--command to notify.  
**Roger**--message received and understood.  
**Say again**--repeat your transmission.  
**Slide**--intentional horizontal movement of an aircraft perpendicular to its heading; will be followed by the word "right" or "left."  
**Slow down**--command to reduce ground speed.  
**Speed up**--command to increase ground speed.  
**Stand by**--wait; duties of a higher priority are being performed and request cannot be complied with at this time.  
**Stop**--command to go no further; halt present action.  
**Strobe**--indicates that the aircraft AN/APR-39 has detected a radar threat; will be followed by a clock direction.  
**Tally**--target, traffic, or obstruction positively seen or identified; will be followed by a repeat of the word "target," "traffic," or "observation" and the clock position.  
**Target**--an alert that a ground threat has been spotted.  
**Traffic**--refers to friendly aircraft that present a potential hazard to the current route of flight; will be followed by an approximate clock position and the distance from your aircraft with a reference to altitude (high or low).  
**Transfer of controls**--positive three-way transfer of the flight controls between the rated crew members; for example, "I have the controls," "You have the controls," and "I have the controls."  
**Troops on/out**--command to have troops enter or exit the aircraft.  
**Turn**--command to deviate from present ground track; will be followed by words "right" or "left," specific heading in degrees, a bearing ("Turn right 30 degrees"), or instructions to follow a well-defined contour ("Follow the draw at 2 o'clock").  
**Unable**--indicates the inability to comply with a specific instruction or request.  
**Up on**--indicates primary radio selected; will be followed by radio position numbers on the intercommunication panels ("Up on 1, up on 3").  
**Weapons hot/cold/off**--weapon switches are in the ARMED, SAFE, or OFF position.  
**Wilco**--I have received your message, I understand, and I will comply.

Figure 6-4. Examples of standard words and phrases (continued)

## OTHER INTERESTING RESOURCES AND USEFUL STUFF

DCS MI-8 DRAFT MANUAL

[https://www.digitalcombatsimulator.com/upload/iblock/3a2/DCS-Mi-8MTV2\\_FlightManual\\_EN.pdf](https://www.digitalcombatsimulator.com/upload/iblock/3a2/DCS-Mi-8MTV2_FlightManual_EN.pdf)

LINO\_GERMANY'S NAVIGATION MAP

<http://www.digitalcombatsimulator.com/en/files/588673/>

FAA HELICOPTER FLYING HANDBOOK

[http://www.faa.gov/regulations\\_policies/handbooks\\_manuals/aviation/helicopter\\_flying\\_handbook/](http://www.faa.gov/regulations_policies/handbooks_manuals/aviation/helicopter_flying_handbook/)

FAA MANUAL CHAPTER 15: NAVIGATION

[http://www.faa.gov/regulations\\_policies/handbooks\\_manuals/aviation/pilot\\_handbook/media/PHAK%20-%20Chapter%2015.pdf](http://www.faa.gov/regulations_policies/handbooks_manuals/aviation/pilot_handbook/media/PHAK%20-%20Chapter%2015.pdf)



## OTHER INTERESTING RESOURCES AND USEFUL STUFF

**WINGS OF RUSSIA: MI-8 THE MAGNIFICENT EIGHT (HIGHLY RECOMMENDED)**

PART 1: <https://www.youtube.com/watch?v=nIFT6GK4RAg>

PART 2: <https://www.youtube.com/watch?v=sRL6hcrBSLc>

**VSTERMINUS' YOUTUBE CHANNEL (HIGHLY RECOMMENDED)**

[https://www.youtube.com/watch?list=PLLZXnPUD\\_ish7UIqf9TKxbg4bK5bzkwKx&v=SXoS2N3M5Mw](https://www.youtube.com/watch?list=PLLZXnPUD_ish7UIqf9TKxbg4bK5bzkwKx&v=SXoS2N3M5Mw)

**SLOCKETSEVEN'S YOUTUBE CHANNEL**

[https://www.youtube.com/playlist?list=PLRxU\\_Js1stPpx4HS3ooaq0T\\_ynVRjXA7m](https://www.youtube.com/playlist?list=PLRxU_Js1stPpx4HS3ooaq0T_ynVRjXA7m)

**TEACH YOURSELF DCS YOUTUBE CHANNEL**

<https://www.youtube.com/playlist?list=PLpWui61PBlo3C5XWjFa5Yop5xolL2oTdM>

# THANK YOU TO ALL MY PATRONS

Creating these guides is no easy task, and I would like to take the time to properly thank every single one of my [Patreon](#) supporters. The following people have donated a very generous amount to help me keep supporting existing guides and work on new projects as well:

- [ChazFlyz](#)
- JJ “Baltic Pirate”





- INSTANT ACTION
- CREATE FAST MISSION
- TRAINING
- MISSION
- CAMPAIGN
- REPLAY
- MULTIPLAYER
- MISSION EDITOR
- CAMPAIGN BUILDER
- ENCYCLOPEDIA
- OPTIONS
- LOGBOOK
- MODULE MANAGER
- EXIT



**A-10C** 1.2.16   
**Bf 109 K-4** 1.2.16 beta   
**C-101EB** 1.2.16.1 Beta   
**CA** 1.2.16   
**F-86F** 1.2.16 beta   
**FC3** 1.2.16   
**Fw 190 D-9** 1.2.16   
**Hawk** 1.2.16 Beta   
**Ka-50** 1.2.16   
**Mi-8MTV2** 1.2.16 beta   
**MiG-15bis** 1.2.16 beta   
**MiG-21Bis** 1.2.15   
**P-51D** 1.2.16   
**Su-25T** 1.2.16   
**TF-51D** 1.2.16   
**UH-1H** 1.2.16